

# Wide band Digital Step Attenuator

## ZX76-31R75PP+

50Ω 0 to 31.75 dB, 0.25 dB Step 9 kHz to 6.0 GHz  
7 Bit, Parallel control interface, Single Supply Voltage

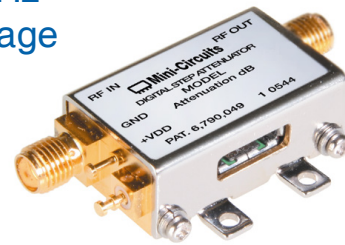

CASE STYLE: HK1172

## The Big Deal

- Wideband, operates up to 6 GHz
- Immune to latchup
- High IP3, 53 dBm
- Control inputs buffered by Schmitt Triggers

## Product Overview

The ZX76-31R75PP+ is a 50Ω digital step attenuator model which provides adjustable attenuation from 0 to 31.75 dB in 0.25 dB steps. The control is a 7-bit parallel interface, with a single positive supply voltage. Control lines are buffered by Schmitt Triggers to allow a wide range of control voltage levels. The model is produced using a unique unibody case package for ruggedness and operation in tough environments.

## Key Features

Feature	Advantages
Wideband operation, specified from 9 kHz to 6.0 GHz	Can be used in multiple applications such as communications, satellite and defense, reducing part count.
Parallel control interface with wide control voltage range	Uses a simple parallel control interface with no clock required and can accept commands with '1' from 1.17V to 5V making it suitable for a wide range of applications.
Good VSWR, 1.45:1 typ.	Eases interfacing with adjacent components and results in low amplitude ripple.
Glitch-less attenuation transitions	The ZX76-31R75PP+ employs novel architecture to reduce the RF output power spikes during attenuation transition to 0.3 dB Typ thus reducing noise in the system and eliminating the risk of a transient spike damaging sensitive components in the system.
Single positive supply	Use of single positive supply simplifies power supply design. An internal negative voltage generator supplies the desired negative voltage. Single positive supply results in excellent spurious performance, -110 dBm typical.
Power Supply 3.0 to 5.5 V	Model suitable for both 5V and 3.3V systems applications with no voltage dividers or multipliers needed.



# Digital Step Attenuator 50Ω 0.009-6000 MHz

31.75 dB, 0.25 dB Step

7 Bit, Parallel control interface, Single Supply Voltage

## Product Features

- Low Insertion Loss
- High IP3, +53 dBm Typ
- Very good return loss, 15 dB Typ
- Excellent accuracy, 0.1 dB Typ
- Glitch-less attenuation transitions
- Single Supply Voltage:  $V_{DD}=+3.3V$  or  $5V$
- Control inputs buffered by Schmitt Triggers
- Rigid unibody case
- Protected by US patent 6,790,049

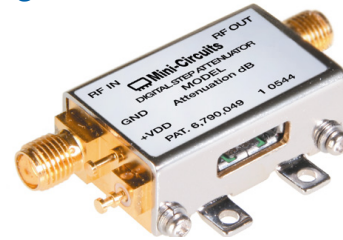

## ZX76-31R75PP+

CASE STYLE: HK1172

Connectors	Order P/N
SMA	ZX76-31R75PP-S+

### +RoHS Compliant

The +Suffix identifies RoHS Compliance. See our web site for RoHS Compliance methodologies and qualifications

## Typical Applications

- Lab
- Instrumentation
- Test equipment

## General Description

The ZX76-31R75PP+ is a 50Ω digital step attenuator provides adjustable attenuation of 0 to 31.75 dB in 0.25 dB steps. The control is a 7-bit parallel interface, and the attenuators operate on a single (positive) supply voltage of 3.0V to 5.5V. The ZX76-31R75PP+ is produced using a unique case package for ruggedness and operation in tough environments.

## Simplified Schematic

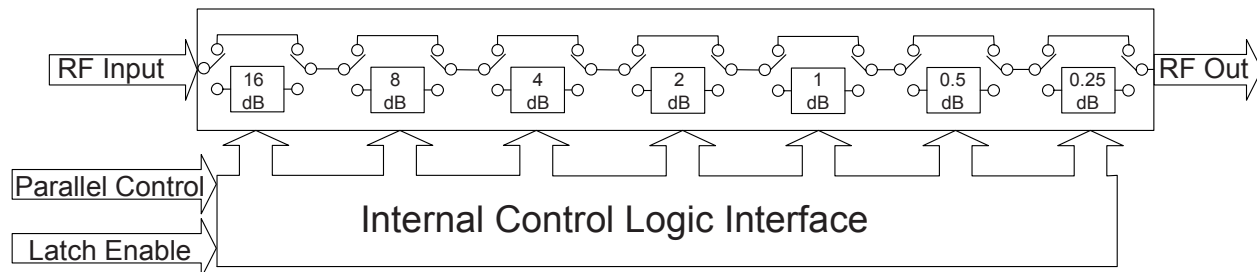

## RF Electrical Specifications, 9 kHz - 6 GHz, $T_{AMB}=25^{\circ}C$ , $V_{DD}=+3.3V$

Parameter	Freq. Range	Min.	Typ.	Max.	Units
Accuracy @ 0.25 dB Attenuation Setting	9 kHz - 3 GHz	—	±0.02	±0.20	dB
	3 GHz - 4 GHz	—	±0.03	±0.25	
	4 GHz - 6 GHz	—	±0.08	±0.25	
Accuracy @ 0.5 dB Attenuation Setting	9 kHz - 3 GHz	—	±0.05	±0.25	dB
	3 GHz - 4 GHz	—	±0.03	±0.25	
	4 GHz - 6 GHz	—	±0.08	±0.25	
Accuracy @ 1 dB Attenuation Setting	9 kHz - 3 GHz	—	±0.04	±0.20	dB
	3 GHz - 4 GHz	—	±0.05	±0.25	
	4 GHz - 6 GHz	—	±0.10	±0.30	
Accuracy @ 2 dB Attenuation Setting	9 kHz - 3 GHz	—	±0.03	±0.20	dB
	3 GHz - 4 GHz	—	±0.05	±0.30	
	4 GHz - 6 GHz	—	±0.12	±0.35	
Accuracy @ 4 dB Attenuation Setting	9 kHz - 3 GHz	—	±0.09	±0.25	dB
	3 GHz - 4 GHz	—	±0.12	±0.35	
	4 GHz - 6 GHz	—	±0.29	±0.60	
Accuracy @ 8 dB Attenuation Setting	9 kHz - 3 GHz	—	±0.16	±0.40	dB
	3 GHz - 4 GHz	—	±0.30	±0.50	
	4 GHz - 6 GHz	—	±0.48	±0.80	
Accuracy @ 16 dB Attenuation Setting	9 kHz - 3 GHz	—	±0.30	±0.60	dB
	3 GHz - 4 GHz	—	±0.45	±0.80	
	4 GHz - 6 GHz	—	±0.75	±1.05	
Insertion Loss @ all attenuator set to 0dB	9 kHz - 3 GHz	—	1.40	3.0	dB
	3 GHz - 4 GHz	—	2.10	3.5	
	4 GHz - 6 GHz	—	2.60	4.0	
Input IP3 <sup>(note 1)</sup> (at Min. and Max. Attenuation)	1 MHz - 6 GHz	—	+53	—	dBm
Input Power @ 0.2dB Compression <sup>(note 1,2)</sup> (at Min. and Max. Attenuation)	1 MHz - 6 GHz	—	+30	—	dBm
Input Operating Power	0.009 to 50 MHz	—	—	Note 2	dBm
	50 - 6000 MHz	—	—	+23	
VSWR	9 kHz - 3 GHz	—	1.40	—	:1
	3 GHz - 4 GHz	—	1.35	—	
	4 GHz - 6 GHz	—	1.70	—	
Attenuation Transient Envelope	9 kHz - 6 GHz	—	0.3	—	dB

Notes:

1. Input IP3 and 1dB compression degrade below 1 MHz. Input power not to exceed max operating specification for continuous operation.
2. Derate linearly from +23 dBm at 50 MHz to +9 dBm at 1 MHz. Power handling below 1 MHz remains constant at +9 dBm.

### DC Electrical Specifications

Parameter	Min.	Typ.	Max.	Units
$V_{DD}$ , Supply Voltage	3.0	3.3	5.5	V
$I_{DD}$ Supply Current	—	—	3500	μA
Control Input Low	-0.3	—	+0.6	V
Control Input High	1.17	—	5.5	V
Control Current	—	—	400	μA

### Switching Specifications

Parameter	Min.	Typ.	Max.	Units
Switching Speed, 50% Control to 0.5dB of Attenuation Value	—	300	—	nsec
Switching Control Frequency	—	25	—	kHz

### Absolute Maximum Ratings<sup>(Note 1,2)</sup>

Parameter		Ratings
Operating Temperature		-40°C to 85°C
Storage Temperature		-40°C to 85°C
V <sub>DD</sub>		-0.3V Min., 6V Max.
Voltage on any control input		-0.3V Min., 6V Max.
ESD, HBM		500V
ESD, MM		100V
Input Power	DC to 1 MHz	+12 dBm
	1 to 50 MHz	Derate linearly from +26 dBm at 50 MHz to +12 dBm at 1 MHz
	50 to 6000 MHz	+31dBm (Note 3)

1. Permanent damage may occur if any of these limits are exceeded.
2. Operation between max operating and absolute max input power will result in reduced reliability.
3. There is a discontinuity in Absolute Maximum power at 50 MHz changing from +26 dBm to +31 dBm

### Pin Description

Function	Pin Number	Description
LE	J1-1	Latch Enable Input
C1	J1-2	Control for attenuation bit, 1 dB
C0.5	J1-3	Control for attenuation bit, 0.5 dB
C0.25	J1-4	Control for attenuation bit, 0.25 dB
C16	J1-5	Control for attenuation bit, 16 dB
GND	J1-6	Ground connection
GND	J1-7	Ground connection
C4	J1-8	Control for attenuation bit, 4 dB
C8	J1-9	Control for attenuation bit, 8 dB
C2	J1-10	Control for attenuation bit, 2 dB
RF in	J2	RF in port (Note 1)
RF out	J3	RF out port (Note 1)
GND	P1	Ground connection
V <sub>DD</sub>	P2	Positive Supply Voltage

Note 1: Both RF ports must be held at 0VDC or DC blocked with an external series capacitor.

### Pin Configuration

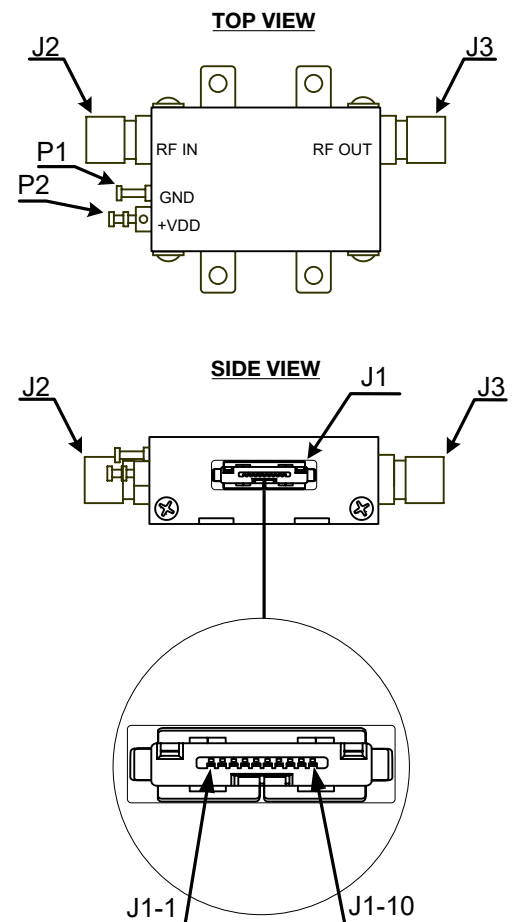

## Simplified Schematic

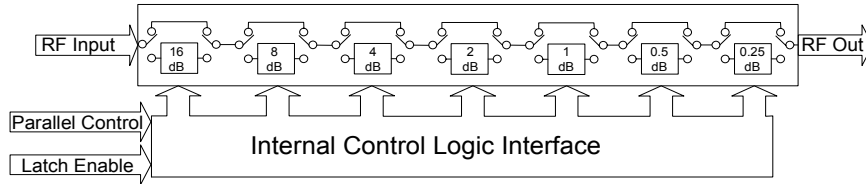

The ZX76-31R75PP+ parallel interface consists of 7 control bits that select the desired attenuation state, as shown in Table 1: Truth Table

Attenuation State	C16	C8	C4	C2	C1	C0.5	C0.25
Reference	0	0	0	0	0	0	0
0.25 (dB)	0	0	0	0	0	0	1
0.5 (dB)	0	0	0	0	0	1	0
1 (dB)	0	0	0	0	1	0	0
2 (dB)	0	0	0	1	0	0	0
4 (dB)	0	0	1	0	0	0	0
8 (dB)	0	1	0	0	0	0	0
16 (dB)	1	0	0	0	0	0	0
31.75 (dB)	1	1	1	1	1	1	1

Note: Not all 128 possible combinations of C0.25 - C16 are shown in table

The parallel interface timing requirements are defined by Figure 1 (Parallel Interface Timing Diagram) and Table 2 (Parallel Interface AC Characteristics), and switching speed.

For latched parallel programming the Latch Enable (LE) should be held LOW while changing attenuation state control values, then pulse LE HIGH to LOW (per Figure 1) to latch new attenuation state into device.

For direct parallel programming, the Latch Enable (LE) line should be pulled HIGH. Changing attenuation state control values will change device state to new attenuation. Direct mode is ideal for manual control of the device (using hardware, switches, or jumpers).

Figure 1: Parallel Interface Timing Diagram

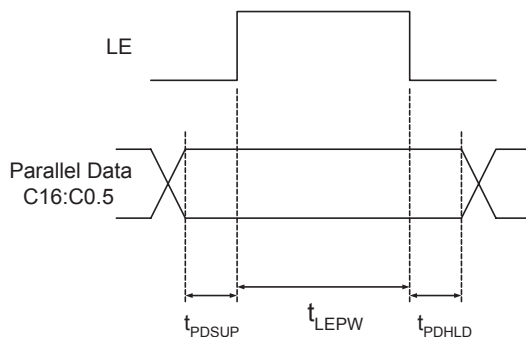

Symbol	Parameter	Min.	Units
$t_{LEPW}$	LE minimum pulse width	10	ns
$t_{PDSUP}$	Data set-up time before clock rising edge of LE	10	ns
$t_{PDHL}$	Data hold time after clock falling edge of LE	10	ns

## Power-up State

When the attenuator powers up and LE is logic low, the nominal attenuation is set on 0 dB. When LE is logic high, the nominal attenuation selected upon control logics ( see Table 1 ).

## Recommended Accessories

An optional cable accessory which is available with ZX76-31R75PP+, the CBL-5FT-MPD+ 'pig tail' cable. CBL-5FT-MPD+ is a shielded cable with a 'pig tail' (bare wires) end allowing customer to assemble their own cable with any connector they need. Cable length is 4.9 feet / 1.5 meters.

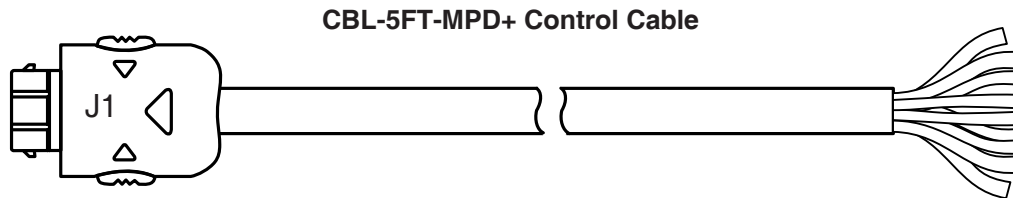

**CBL-5FT-MPD+ wiring information**

J1 Pin Number	Function	Description	Wire Color
1	LE	Latch Enable Input	Green
2	C1	Control for attenuation bit, 1 dB	Green/Black
3	C0.5	Control for attenuation bit, 0.5 dB	Red
4	C0.25	Control for attenuation bit, 0.25 dB	Orange
5	C16	Control for attenuation bit, 16 dB	Orange/Black
6	GND	Ground connection	Black
7	GND	Ground connection	Red/Black
8	C4	Control for attenuation bit, 4 dB	Blue
9	C8	Control for attenuation bit, 8 dB	White
10	C2	Control for attenuation bit, 2 dB	White/Black

Note: Cable shield connected to case ground.

## Ordering Information

Model Number	Description
ZX76-31R75PP-S+	Digital attenuator - Parallel interface Single Voltage (Positive Voltage)
CBL-5FT-MPD+	Cable accessory without interface connector

## Additional Detailed Technical Information

additional information is available on our dash board. To access this information [click here](#)

<b>Performance Data</b>	Data Table
	Swept Graphs
	S-Parameter (S2P Files) Data Set (.zip file)
<b>Case Style</b>	HK1172
<b>Environmental Ratings</b>	ENV28T14

## Additional Notes

- A. Performance and quality attributes and conditions not expressly stated in this specification document are intended to be excluded and do not form a part of this specification document.
- B. Electrical specifications and performance data contained in this specification document are based on Mini-Circuit's applicable established test performance criteria and measurement instructions.
- C. The parts covered by this specification document are subject to Mini-Circuits standard limited warranty and terms and conditions (collectively, "Standard Terms"); Purchasers of this part are entitled to the rights and benefits contained therein. For a full statement of the Standard Terms and the exclusive rights and remedies thereunder, please visit Mini-Circuits' website at [www.minicircuits.com/MCLStore/terms.jsp](http://www.minicircuits.com/MCLStore/terms.jsp)

