



USB & ETHERNET

Mechanical Switch Assembly **ZTM2-24SPDT-18**

50Ω DC to 18 GHz 24 x SPDT Rack-Mount SMA Female

THE BIG DEAL

- 24 x mechanical SPDT absorptive switches
- Convenient rack-mountable chassis
- SSH secure Ethernet communication
- Fail-safe / redundancy switching
- LED switch state indicators



Generic photo used for illustration purposes only

APPLICATIONS

- Benchtop and rack-mounted automated test systems
- 5G FR1, WiFi 6E MIMO, UWB, Bluetooth
- Military radio, radar & electronic warfare
- Microwave radio & cellular infrastructure
- Switch matrices

FUNCTIONAL BLOCK DIAGRAM

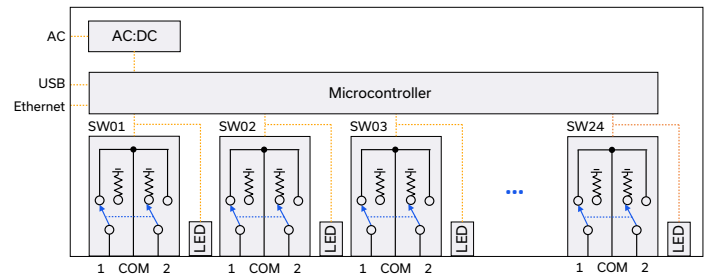

PRODUCT OVERVIEW

Mini-Circuits' ZTM2-24SPDT-18 houses 24 independently controlled electro-mechanical SPDT switches. Each switch operates over a wide bandwidth, from DC to 18 GHz with high isolation and low insertion loss. The absorptive switches are failsafe, with a break-before-make configuration, and lifetime of 5 million switching cycles when used within the noted specifications.

The switches are housed in a 19-inch rack chassis, 5U height, with all SMA (female) RF connectors on the front. LED switch state indicators on the front panel enable visual display of all switch states. The switch assembly can be controlled via USB or Ethernet (supporting SSH, HTTP and Telnet network protocols). Full software support is provided, including our user-friendly GUI application for Windows and a full API with programming instructions for Windows and Linux environments.

The modular design of the ZTM2 series switch rack supports easy maintenance and re-configuration in the field, without the need to return the whole system to a Mini-Circuits facility. Custom switch configurations can be configured to fit any requirement, using Mini-Circuits' online configurator tool at www.minicircuits.com/WebStore/ztm2.html.

KEY FEATURES

Feature	Advantages
Mechanical switches	Mechanical absorptive switches provide low loss, high isolation, high reliability, repeatable performance and internal termination of input signals on the disconnected paths
Flexible & modular design	Configure just the switch combination needed for your test application, with the flexibility to add or change switch modules in future as test requirements evolve.
Secure Ethernet communication	Support for SSH (secure shell protocol) provides a means for secure communication over Ethernet networks with strict security policies. HTTP & Telnet communication via Ethernet are also supported.
Fail-safe design	The switches revert to a known default state when the DC supply is removed, allowing their use in systems that must continue to operate safely in the event of power failure
Rack-mount chassis	Compact 3U height, 19" rack-mountable chassis suits integration in automated production test environments.

**ELECTRICAL SPECIFICATIONS AT +25°C (EACH SWITCH)**

Parameter	Conditions	Min.	Typ.	Max.	Units
Frequency Range	-	DC		18	GHz
Insertion Loss	DC - 8 GHz		0.15	0.30	dB
	8 - 12 GHz		0.25	0.40	
	12 - 18 GHz		0.30	0.50	
Isolation (Inactive Paths) ¹	DC - 8 GHz	75	90		dB
	8 - 12 GHz	70	80		
	12 - 18 GHz	60	66		
Return Loss ²	DC - 8 GHz		20		:1
	8 - 12 GHz		20		
	12 - 18 GHz		19		
Switching Time			25		ms
RF Input Power (Cold Switching)	DC-18 GHz			20	W
	Into internal termination			1	
Switch Lifetime	100 mW hot switching ³		5		million cycles
	1W hot switching		1		

1. Isolation measured between Com and any disconnected port. Example: Isolation for Com to 1 is the leakage measured at port 1 from a signal input at Com when the active switch path is set to Com to 2.

2. Return loss into all ports in all states

3. Hot switching power above this level will degrade the switch lifetime



TYPICAL PERFORMANCE GRAPHS

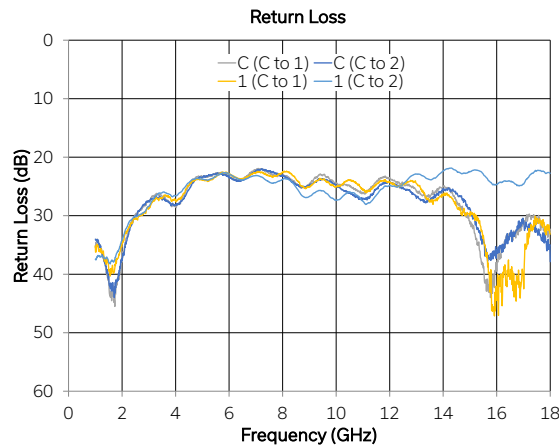
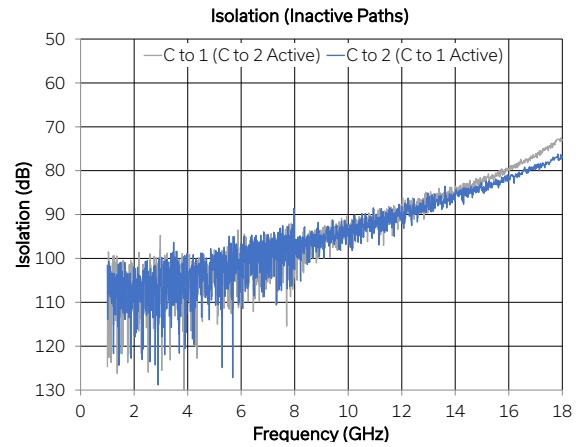
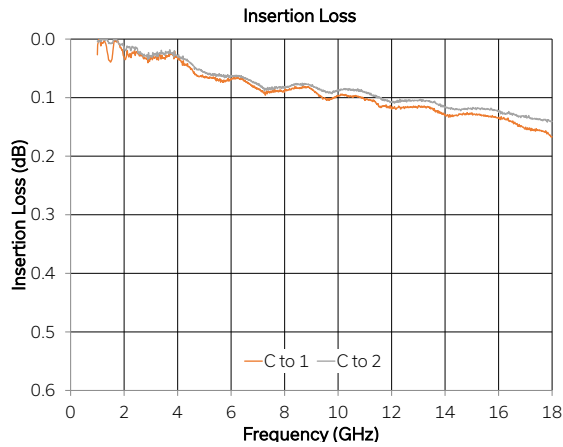

**CONTROL INTERFACES**

Ethernet Control	Supported Protocols	TCP / IP, SSH, HTTP, Telnet, DHCP, UDP (limited)
	Max Data Rate	100 Mbps (100 Base-T Full Duplex)
USB Control	Supported Protocols	HID – High Speed
	Min Communication Time ⁴	400 μs typ

4. Based on the polling interval of the USB HID protocol (125 μs with 64 bytes per packet) and no other significant CPU or USB activity

SOFTWARE & DOCUMENTATION

Mini-Circuits' full software and support package including user guide, Windows GUI, API, programming manual and examples can be downloaded free of charge (refer to the last page for the download path).

A comprehensive set of software control options is provided:

- GUI for Windows – Simple software interface for control via Ethernet and USB
- Programming / automation via Ethernet
 - Complete set of control commands which can be sent via any supported protocol – simple to implement in the majority of modern programming environments
- Programming / automation via USB
 - DLL files provide a full API for Windows with a set of intuitive functions which can be implemented in any programming environment supporting .Net Framework or ActiveX
 - Direct USB programming is possible in any other environment (not supporting .Net or ActiveX)

Please contact testsolutions@minicircuits.com for support

MINIMUM SYSTEM REQUIREMENTS

Hardware	Intel i3 (or equivalent) or later
GUI (USB or Ethernet Control)	Windows 7 or later
USB API DLL	Windows 7 or later with support for Microsoft .Net Framework or ActiveX
USB Direct Programming	Windows 7 or later; Linux
Ethernet	Windows, Linux or macOS with Ethernet TCP / IP support

PROGRAMMING COMMANDS

The key ASCII / SCPI commands for control of the system for control via the Ethernet or USB API are summarized below (refer to the programming manual for full details):

Command / Query	Description
:MN?	Read model name
:SN?	Read serial number
:FIRMWARE?	Read firmware version
:SPDT:[sw_label]:STATE:[port]	Set a single switch state: <ul style="list-style-type: none"> • [sw_label] = Switch number (1 to 24) • [port] = The port to be connected to Com of the specified switch (1 or 2) • Example :SPDT:1:STATE:2
:SPDT:[sw_label]:STATE?	Get the state of all switches: <ul style="list-style-type: none"> • sw_label] = Switch number (1 to 24) • Example :SPDT:1:STATE?



GRAPHICAL USER INTERFACE (GUI) FOR WINDOWS - KEY FEATURES

- Connect via USB or Ethernet
- Run GUI in "demo mode" to evaluate software without a hardware connection

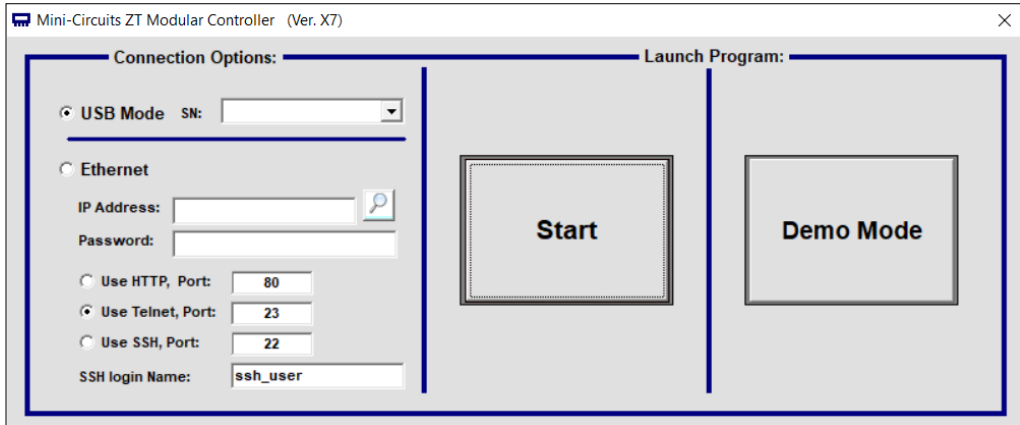

- View and set all switch states at the click of a button
- Configure automated switching sequences
- Define custom switch and port labels
- Set switch power-up states
- Configure Ethernet settings
- Update firmware

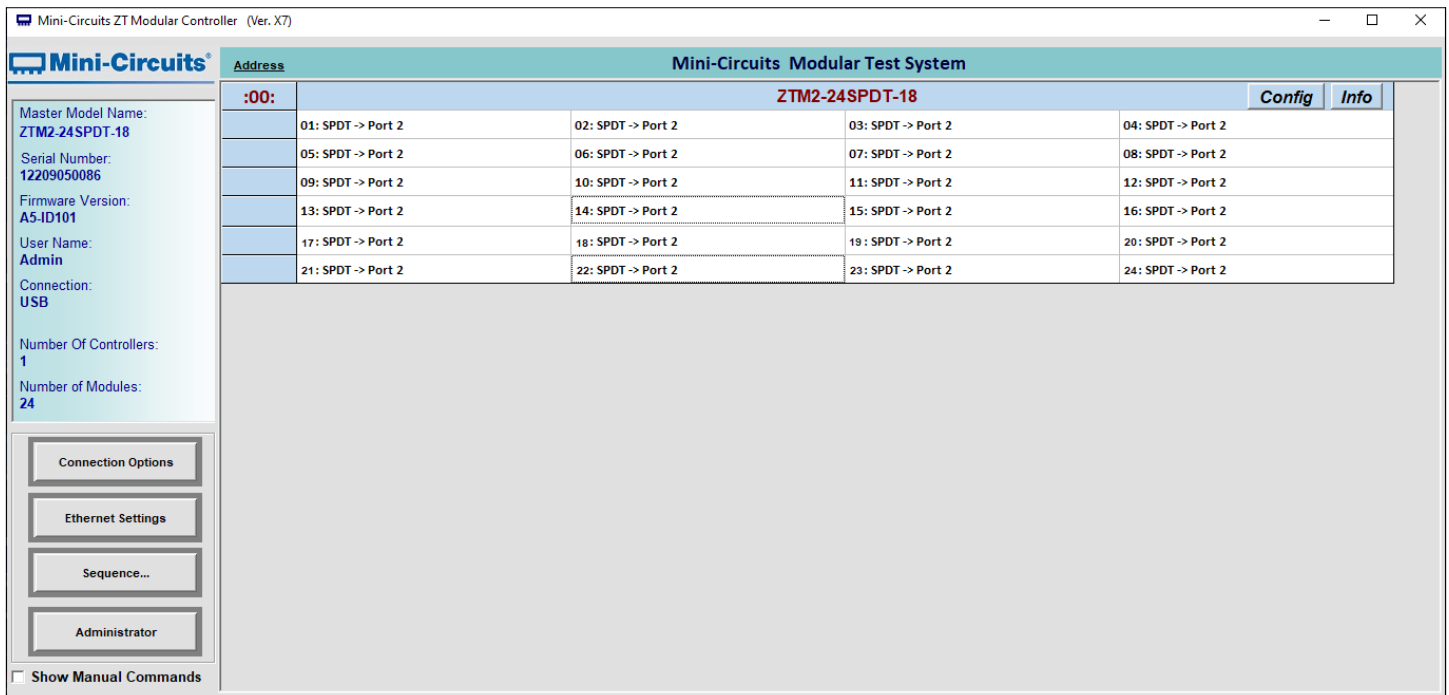



USB & ETHERNET

Mechanical Switch Assembly **ZTM2-24SPDT-18**

Mini-Circuits

50Ω DC to 18 GHz 24 x SPDT Rack-Mount SMA Female

ABSOLUTE MAXIMUM RATINGS

Parameter	Conditions	Limits	Units
Temperature	Operating	0 to +50	°C
	Storage	-20 to +60	
Input Power (No Damage)	Cold switching	20	W
	Hot switching	1	
	Into internal termination	1	

Permanent damage may occur if any of these limits are exceeded. Operating in the range between operating power limits and absolute maximum ratings for extended periods of time may result in reduced life and reliability.

POWER SUPPLY

Power Supply	AC mains input: 100-240 V, 50 / 60 Hz
Fuse	2A, 250V rating
Power Consumption	300W maximum

SWITCH STATE TABLE (EACH SPDT SWITCH)

Switch Command	Switch x State	Switch x LED State
:SPDT:[x]:STATE:1	COM to 1	Green
:SPDT:[x]:STATE:2	COM to 2	Orange

x = switch number (1 to 2)

CONNECTIONS

Port	Connector
COM & 1-2 (each SPDT)	SMA female
USB	USB type B
Ethernet / LAN	RJ45
AC Input	IEC C14 inlet

COM = Common port
1-2 = input / output ports

FUNCTIONAL BLOCK DIAGRAM

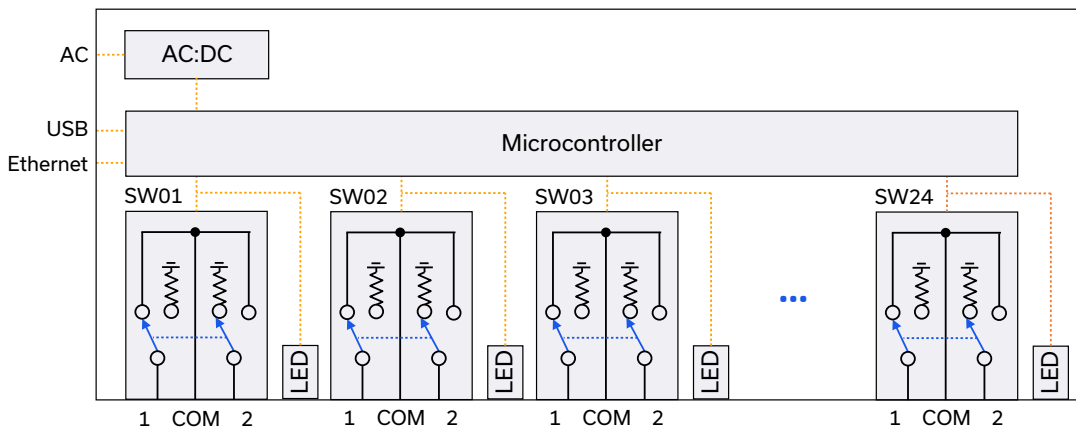



USB & ETHERNET

Mechanical Switch Assembly **ZTM2-24SPDT-18**

50Ω DC to 18 GHz 24 x SPDT Rack-Mount SMA Female

CASE STYLE DRAWING

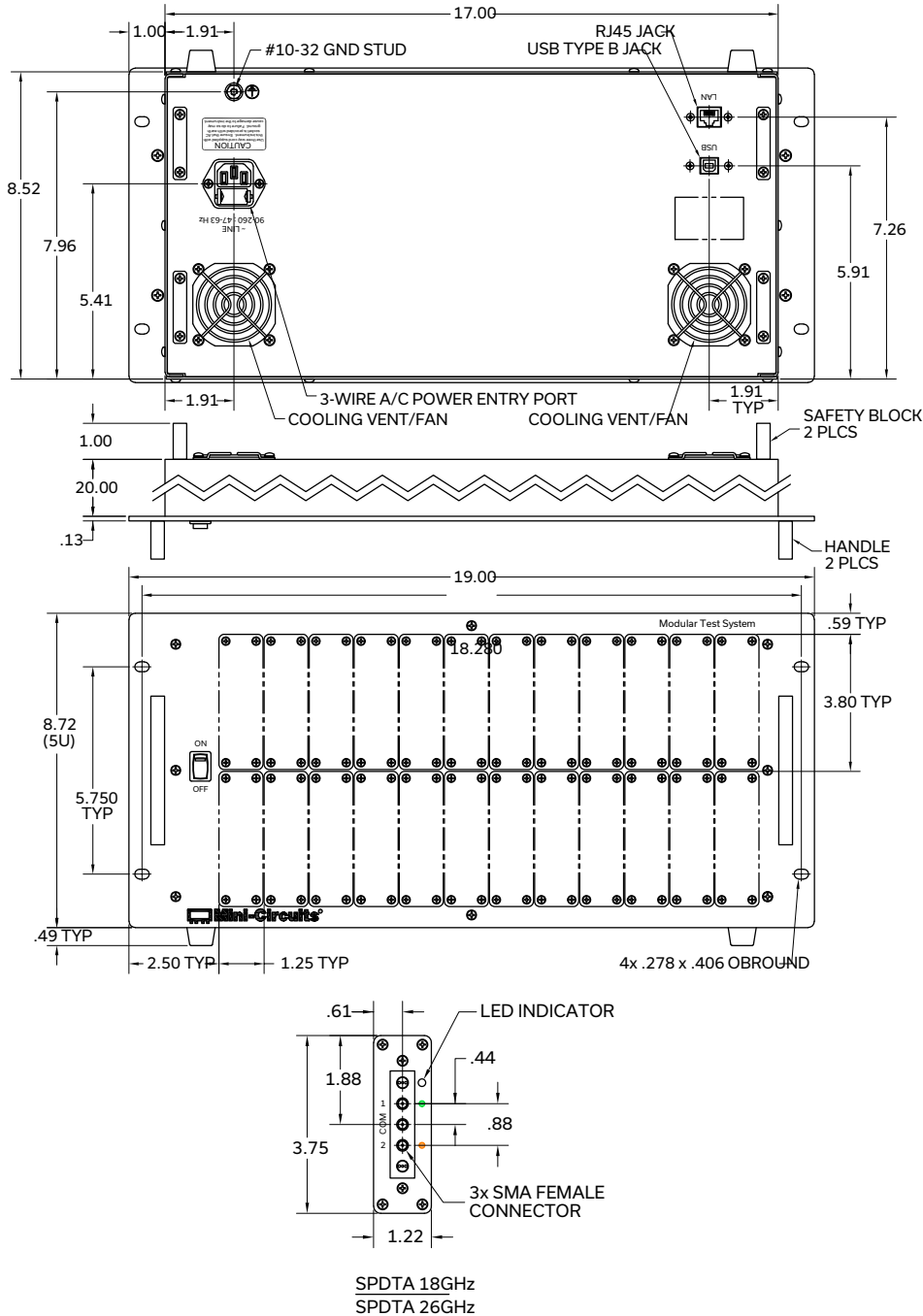

PRODUCT MARKING*

Product Marking: ZTM2-24SPDT-18

Product Description: Modular Test System

Unit ID Label: Serial number and other identification marks

*Marking may contain other features or characters for internal lot control





USB & ETHERNET

Mechanical Switch Assembly **ZTM2-24SPDT-18**











50Ω DC to 18 GHz 24 x SPDT Rack-Mount SMA Female

DETAILED MODEL INFORMATION IS AVAILABLE ON OUR WEBSITE [CLICK HERE](#)

Case Style	YZD2891	
Software, User Guide & Programming Manual	www.minicircuits.com/softwaredownload/ztm_ztm2.html	
Environmental Rating	ENV55	
Regulatory Compliance	<p>Refer to our website for compliance methodologies and qualifications</p> 	www.minicircuits.com/quality/environmental_introduction.html

Contact Us: testsolutions@minicircuits.com

Included Accessories	Part Number	Description
	CBL-3W-xx	AC power cord (IEC C13 connector to local plug) Select one option from the list below. Please contact testsolutions@minicircuits.com if your region is not listed.
	USB-CBL-AB-7+	USB cable (6.8ft) type A to type B
	CBL-RJ45-MM-5+	Ethernet cable (5 ft)
	HT-4-SMA	SMA connector wrench (4" length)

AC Power Cord Options	Part Number	Description
	CBL-3W-US	USA NEMA 5-15 plug (type B) to IEC C13 connector
	CBL-3W-EU	Europe CEE 7/7 plug (type E/F) to IEC C13 connector
	CBL-3W-UK	UK BS-1363 plug (type G) to IEC C13 connector
	CBL-3W-AU	Australia & China AS/NZS 3112 plug (type I) to IEC C13 connector
	CBL-3W-IL	Israel SI-32 plug (type H) to IEC C13 connector

- NOTES
- Performance and quality attributes and conditions not expressly stated in this specification document are intended to be excluded and do not form a part of this specification document.
 - Electrical specifications and performance data contained in this specification document are based on Mini-Circuit's applicable established test performance criteria and measurement instructions.
 - The parts covered by this specification document are subject to Mini-Circuits standard limited warranty and terms and conditions (collectively, "Standard Terms"); Purchasers of this part are entitled to the rights and benefits contained therein. For a full statement of the standard terms and the exclusive rights and remedies thereunder, please visit Mini-Circuits' website at www.minicircuits.com/terms/viewterm.html

