



USB & ETHERNET & DAISY-CHAIN

Signal Generator

SSG-8N12GD-RC



50Ω 8 to 12.5 GHz -55 dBm to +23 dBm SMA Female Dual Channel

THE BIG DEAL

- Two independently tunable channels
- Cost effective X-band signal generator
- High output power, +23 dBm
- Excellent harmonics & phase noise
- CW, pulsed, AM, FM & chirp outputs
- Daisy-chain for multi-module dynamic control
- Power over Ethernet (PoE) enabled

APPLICATIONS

- Semiconductor high power burn-in & life testing
- Benchtop signal generator
- Automated production test systems
- X-band radar testing
- Quantum computing

PRODUCT OVERVIEW

Mini-Circuits' SSG-8N12GD-RC is a dual-channel wide-band signal generator operating from 8 to 12.5 GHz. With up to +23 dBm typical output power, it is an ideal signal source for characterization of millimeter wave components and systems at high power. Configure CW / single-tone outputs, flexible pulse sequences, AM, FM and Chirp modulations, or automated frequency / power sweep & hop sequences.

SSG-8N12GD-RC has been developed in a compact package with powerful software control and automation to provide a cost effective X-band signal generator and LO source for any bench or production test application. This is a high quality, repeatable and reliable signal source with low phase noise and excellent harmonic rejection.

The generator can be controlled via USB or Ethernet (supporting SSH, HTTP & Telnet protocols). Full software support is provided, including our user-friendly GUI application for Windows, flexible API and programming instructions for Windows and Linux environments. The daisy-chain control interface with "dynamic addressing" simplifies control integration and allows multiple units to be combined into a multi-channel signal source with control through a single software interface.

KEY FEATURES

Feature	Advantages
High quality signal source	Outstanding combination of fine frequency and power resolution, low phase noise and excellent harmonic rejection, and low spurious signals in a compact package; with two independently tunable channels suited for a wide range of applications .
Dual Channel	The two channels can operate independently and in coherent or non-coherent modes with 2.8° phase resolution for the complete 360° range.
Flexible pulse, AM, FM and Chirp modulation	Configure various analog modulations according to your needs.
Sweep & Hop sequences	Configure custom CW output frequency and power sequences to run unaided for high speed, automated test applications.
USB & Ethernet control	USB HID and Ethernet (HTTP / Telnet / SSH) interfaces provide easy compatibility with a wide range of software setups and programming environments.
Dynamic daisy-chain control	Simplify control software and interconnections and develop low-cost, multi-channel signal generator systems by daisy-chaining multiple units with control through a single interface.

Trademarks:

Windows is a registered trademark of Microsoft Corporation in the United States and other countries ; Linux is a registered trademark of Linus Torvalds ; Pentium is a registered trademark of Intel Corporation. Neither Mini-Circuits nor the Mini-Circuits products are affiliated with or endorsed by the owners of the referenced trademarks. Mini-Circuits and the Mini-Circuits logo are registered trademarks of Scientific Components Corporation.



Generic photo used for illustration purposes only





ELECTRICAL SPECIFICATIONS ¹, +25°C

Parameter	Condition (GHz)		Min.	Typ.	Max.	Unit
Output Frequency	-		8	-	12.5	GHz
Frequency Resolution ²	8 - 12.5		-	1	-	Hz
Frequency Accuracy	Using internal reference		-	±1	-	ppm
Return Loss	8 - 12.5		-	-10	-	dB
Output Power Max	8 - 12.5		+20	+23	-	dBm
Output Power Min	8 - 12.5		-	-55	-50	dBm
Power Resolution (nominal)	8 - 12.5		-	0.1	-	dB
Output Power Accuracy	8 - 12.5	-50 to +20 dBm	-	±0.5	±1.0	dB
RF Output Leakage	8 - 12.5	Both channels @ RF off	-	-80	-	dBm
RF Leakage between channels	8 - 12.5	One channel @ RF off	-	-70	-	dBm
Harmonics	8 - 12.5	-50 to +20 dBm	-	-30	-	dBc
Non-Harmonic Spurious	Offsets 1 MHz to 150 MHz	-50 to +20 dBm	-	-70	-60	dBc
	Offsets 1 kHz to 1 MHz		-	-35	-30	
Boundary Spurs	8 - 12.5		-	-40	-	
Settling Time ^{3,4}	Hop mode ⁵	8 - 12.5	-	0.1	0.15	ms
	Frequency sweep	8 - 12.5	-	0.1	0.15	
	PC (external) control		-	2	-	
	Power transition (at set frequency)		-	0.004	-	
Dwell Time (nominal) ^{4,6}	-		0.01	-	10,000	ms
Phase Offset Range	-		0	-	359	deg
Phase Offset Resolution	-		-	1	-	

1. Specifications are after 15 minutes warm-up time.
2. Frequency Resolution is tested with 10 MHz external reference.
3. Settling Time - transition time between 2 output states. During the transition, RF output is turned off to avoid transient outputs.
4. Generator response time is Dwell Time + Settling Time.
5. For hop sequences pre-loaded into internal memory (high-speed mode).
6. Dwell Time - duration of each signal point in a Sweep or Hop sequence set by user. Default is minimum dwell time.



MODULATION SPECIFICATIONS, ⁷ +25°C

Parameter		Condition	Min.	Typ.	Max.	Unit	
Modulation types		AM, FM, Chirp, Pulse (Rising, Falling and bi-directional)					
Max modulation freq		3 dB point	-	-	5	kHz	
FM Max deviation		-	-	50	-	MHz	
AM Modulation depth ⁸		-	0	-	100	%	
Chirp rate		Nominal value	0.0015	-	20	MHz/μs	
Pulse Width Resolution		Nominal value	0.05	-	-	μs	
Pulse Width ^{9,10}		Measured at the 50% of pulse level	Internal Pulse Modulation	5	-	10e6	μs
			External Pulse Modulation	5	-	10e6	
Pulse Period (regular mode)		Measured at the 50% of pulse level	Internal Pulse Modulation	10	-	10e6	μs
			External Pulse Modulation	10	-	10e6	
Pulse interval ¹¹	Fixed freq. & Power	Measured at the 50% of pulse level	-	7	-	4e6	μs
	Varying freq. & Power		-	400	-	4e6	
Pulse Rise / Fall Time ^{12,13}		Measured between 10% and 90% of pulse level	-	60 / 30	-	ns	
Pulse Width Accuracy ¹⁴		Measured at 50% of pulse level	Internal pulse modulation	-	±10	-	%
			External pulse modulation	-	±10	-	
External pulse modulation input threshold		External pulse modulation	3	-	-	V	
Trigger Response Delay		Trigger edge to 50% of pulse level	Internal pulse modulation	-	1	-	μs
			External pulse modulation	-	2	-	
Pulse Power Ratio		PWR _{OUT} = +20 dBm, FREQ _{OUT} = 8 GHz	-	70	-	dB	
		PWR _{OUT} = +20 dBm, FREQ _{OUT} = 12.5 GHz	-	70	-		

7. Regular pulse mode has fixed frequency and power supporting internal and external modulation and input / output trigger options. Dynamic mode allows for flexible RF pulse sequences with varying frequency, power pulse width and pulse repetition interval (PRI).

8. In AM modulation, ensure there is sufficient margin between the carrier power and Generator's Min/Max power spec to allow generating the modulated signal without distortions. For example a modulation depth of 50% translates to power of +1.76 dB to -3.01 dB from the carrier.

9. Pulse Width in normal mode must be less than pulse period by at least 0.5 μs with Internal pulse modulation and by 2 μs in external pulse modulation.

10. Pulse Widths below 0.5 μs can be set, however performance is only guaranteed for the ranges noted in the table.

11. In dynamic mode.

12. Pulse rise time will increase with pulse interval under 3 μs.

13. For signals at same power & frequency.

14. Pulse Width Accuracy is 3% of pulse width, or ±100 ns, whichever is greater.

PHASE NOISE (SSB), +25°C

Frequency Offset (kHz)	Carrier Frequency (GHz)					
	8		10		12.5	
	Typ.	Max	Typ.	Max	Typ.	Max
1	-94.5	-92.5	-92.5	-90.5	-91.0	-88.5
10	-105.5	-103.0	-101.0	-112.5	-101.5	-99.0
100	-113.5	-111.0	-111.0	-108.5	-109.5	-107.0
1,000	-120.5	-117.5	-118.5	-116.0	-111.5	-109.0
10,000	-144.0	-140.0	-145.0	-141.0	-144.0	-141.0
Noise Floor	-150.0	-146.0	-150.0	-146.0	-150.0	-146.0



REFERENCE, TRIGGER & DC POWER, +25°C

Parameter	Condition	Min.	Typ.	Max.	Unit
Aging	Using internal reference	-	2	-	ppm/yr
Reference In	Frequency	-	10	-	MHz
	Power	-3.5	-	+7.5	dBm
	Phase noise	10 kHz Offset	-	-135	dBc/Hz
Reference Out	Frequency	-	10	-	MHz
	Frequency accuracy	Using internal reference	-	±1	ppm
	Power	-	+10	-	dBm
	Phase noise	10 kHz Offset	-	-140	dBc/Hz
Trigger Out ¹⁵	Low	0	-	0.4	V
	High	3.0	-	5.0	
	Pulse width	-	100	-	µs
Trigger In	Low	0	-	0.4	V
	High	3.0	-	5.0	
	Pulse width	-	1	-	µs
Supply Voltage (V _{DC})	DC Input port ¹⁶	5.7	6.0	6.3	V _{DC}
Supply Current (I _{DC})		-	2.2	2.8	A
Supply Current (I _{DC})	USB port ¹⁶	-	20	-	mA
Supply Voltage (V _{DC})	LAN port ^{16, 17}	50	53	57	V _{DC}
Supply Current (I _{DC})		-	300	450	mA

15. Trigger out voltage specified with impedance load of 10 kΩ minimum.

16. Model can not be powered via USB. Power must be provided via either 2.1mm DC Input or LAN port (using PoE systems).

17. Compliant with IEEE 802.3at mode A and mode B.

ABSOLUTE MAXIMUM RATINGS

Operating Temperature	0°C to 50°C
Storage Temperature	-20°C to 60°C
Power in @ Reference in	+10 dBm
Reverse Voltage (DC) @ Reference out	8 V _{DC}
Reverse Voltage (DC) @ RF out	15 V _{DC}
Reverse Power (RF) @ RF out	+24 dBm
Voltage input to trigger ports	-0.3V _{DC} to +5.5V _{DC}

Permanent damage may occur if any of these limits are exceeded. Operating in the range between operating power limits and absolute maximum ratings for extended periods of time may result in reduced life and reliability.



TYPICAL PERFORMANCE GRAPHS (PER CHANNEL)

Power Accuracy vs. Output Frequency

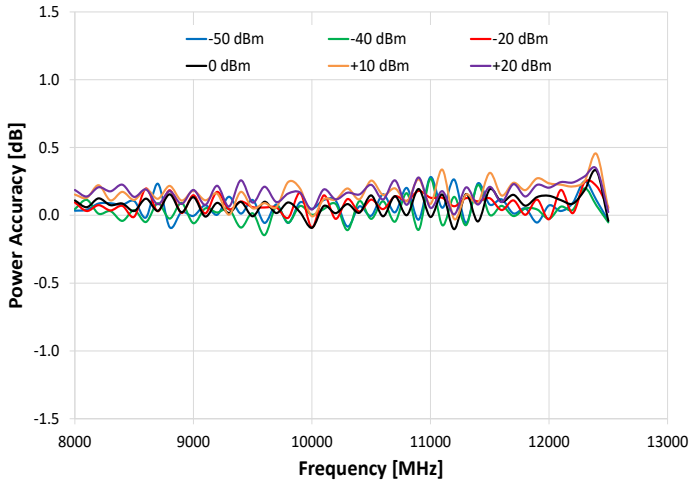

Power Accuracy vs. Output Power

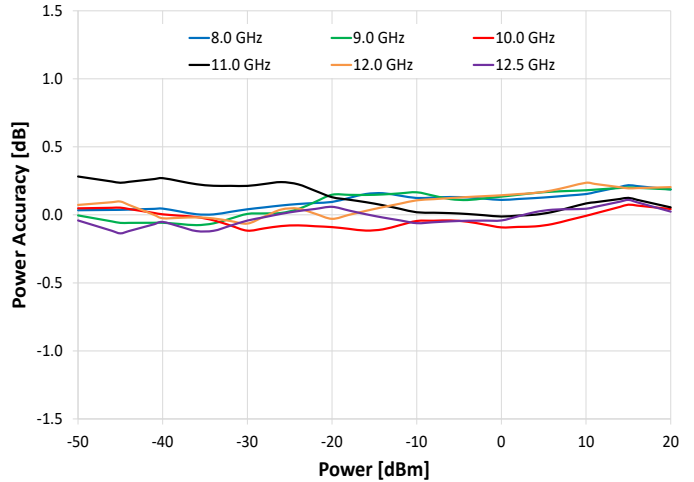

Phase Noise vs. Output Frequency

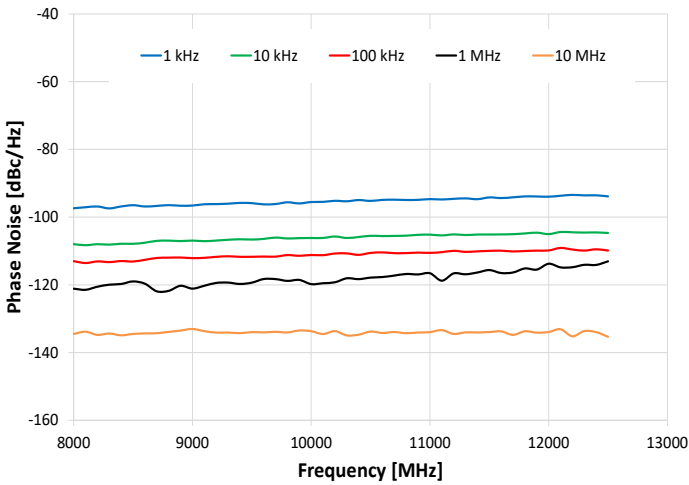

Phase Noise vs. Offset Frequency

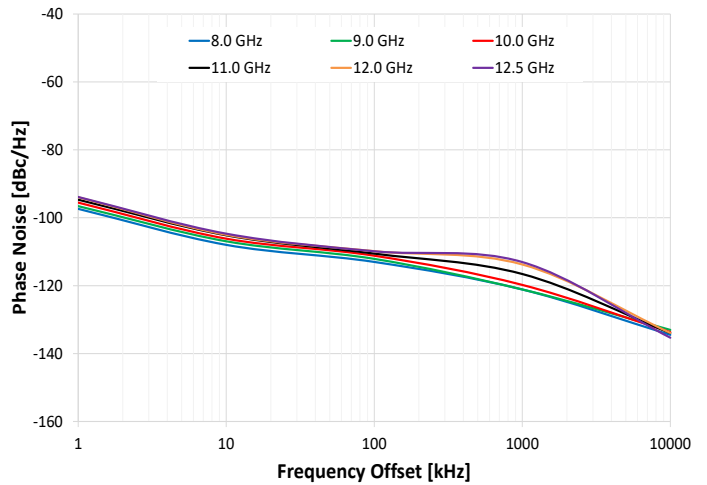

Max Power vs. Output Frequency

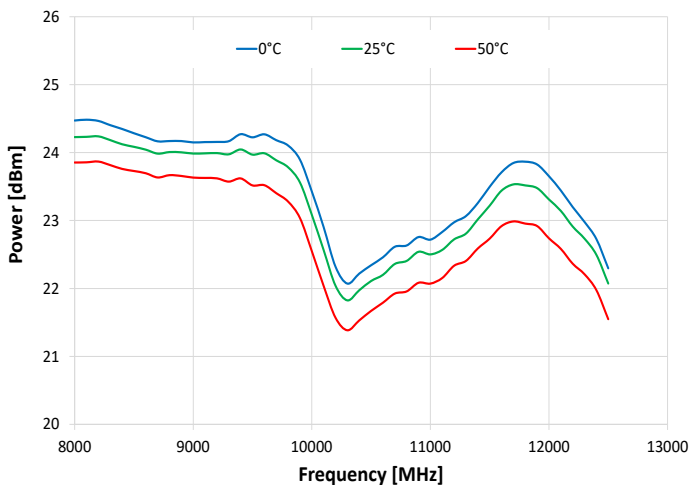

Spurious vs. Output Frequency @ +10 dBm

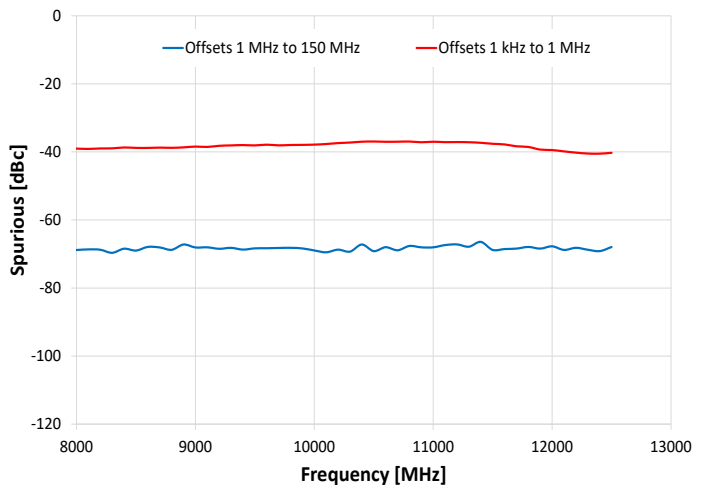



TYPICAL PERFORMANCE GRAPHS (PER CHANNEL, CONTINUED)

Harmonics vs. Output Frequency @ +20 dBm

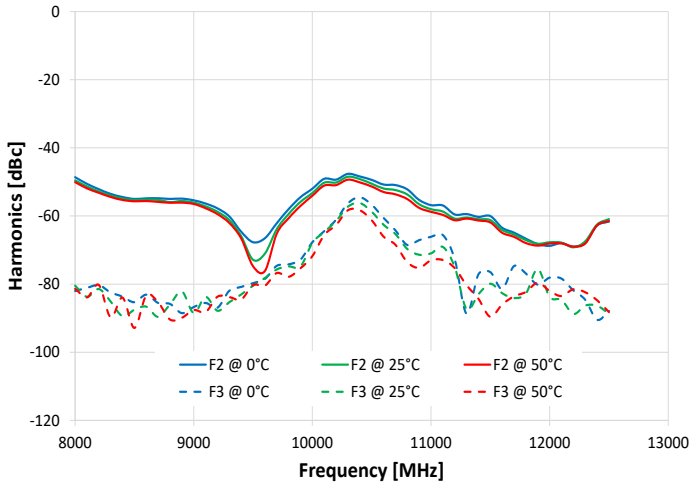

Harmonics vs. Output Frequency @ 0 dBm

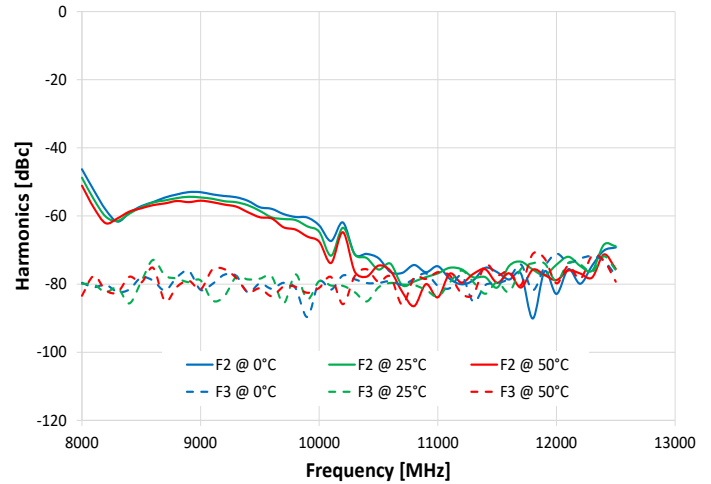

Harmonics vs. Output Frequency @ -20 dBm

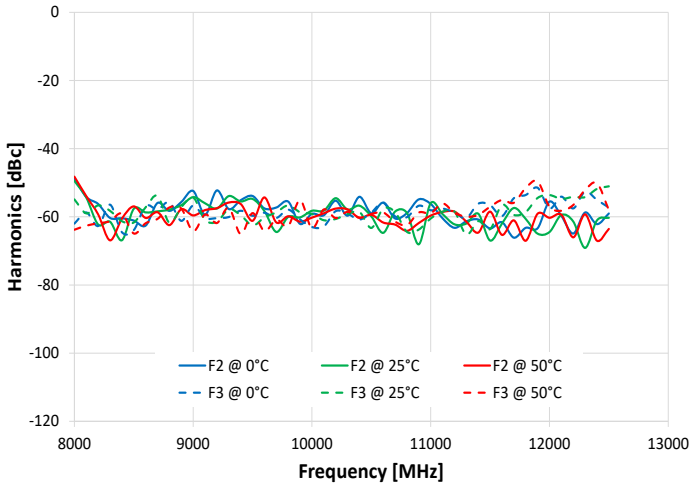

Harmonics vs. Output Frequency @ -40 dBm

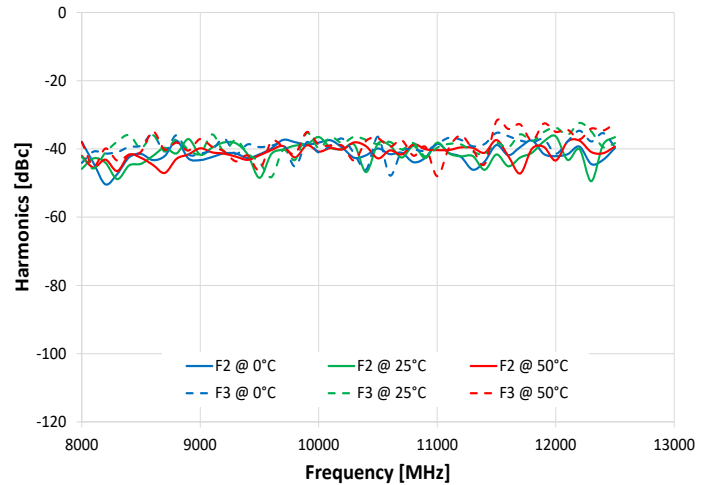

Harmonics vs. Output Frequency @ -50 dBm

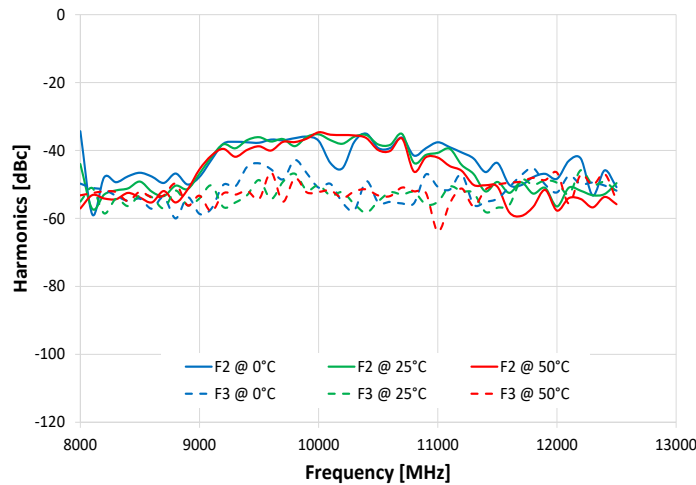



CONTROL INTERFACES

Ethernet Control	Supported Protocols	TCP / IP, HTTP, Telnet, SSH, DHCP, UDP (limited)
	Max Data Rate	100 Mbps (100 Base-T Full Duplex)
USB Control	Supported Protocols	HID (Human Interface Device) - High-speed
	Min Communication Time ¹⁸	400 μs typ (full transmit/receive cycle)

18. USB Min Communication Time is based on the polling interval of the USB HID protocol (125 μs polling interval, 64 bytes per packet), medium CPU load and no other high-speed USB devices using the USB bus.

SOFTWARE & DOCUMENTATION

Mini-Circuits' full software and support package including user guide, Windows GUI, API, programming manual and examples can be downloaded free of charge (refer to the last page for the download path).

A comprehensive set of software control options is provided:

- GUI for Windows – Simple software interface for control via Ethernet and USB.
- Programming / automation via Ethernet:
 - Complete set of control commands which can be sent via any supported protocol.
 - Simple to implement in the majority of modern programming environments.
- Programming / automation via USB:
 - DLL files provide a full API for Windows with a set of intuitive functions which can be implemented in any programming environment supporting .Net Framework or ActiveX.
 - Direct USB programming is possible in any other environment (not supporting .Net or ActiveX).

Please contact testsolutions@minicircuits.com for support.

MINIMUM SYSTEM REQUIREMENTS

GUI	Windows 7 or later
USB API DLL	Windows 7 or later and programming environment with ActiveX or .NET support
USB Direct Programming	Linux, Windows 7 or later
HTTP, Telnet or SSH	Any computer with a network port and Ethernet-TCP/IP (HTTP, Telnet or SSH protocols) support
Hardware	Intel i3 (or equivalent) or later



GRAPHICAL USER INTERFACE (GUI) FOR WINDOWS - KEY FEATURES

- Connect via USB or Ethernet
- Password protected access for safe remote usage over Ethernet

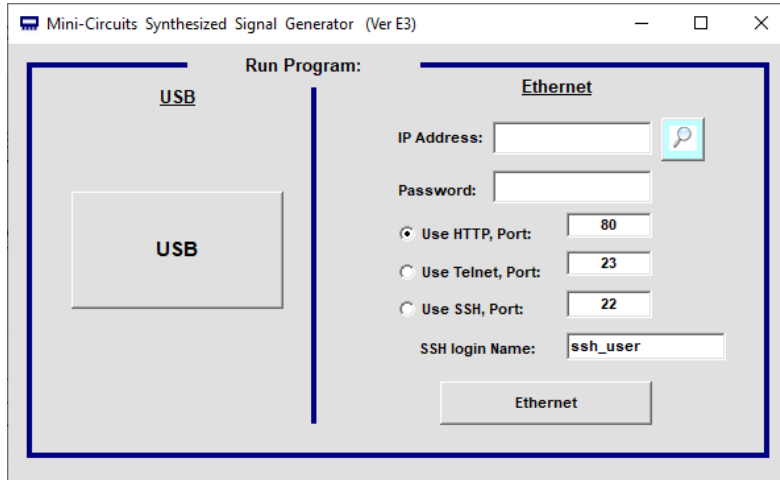

- Set all functions for each channel independently
- Configure output power, frequency, pulse modulation
- Program timed signal output sequences (linear sweep and frequency hop)
- Control timed sequences in multiple generators simultaneously
- Track unit operation time since last calibration and setup calibration reminders

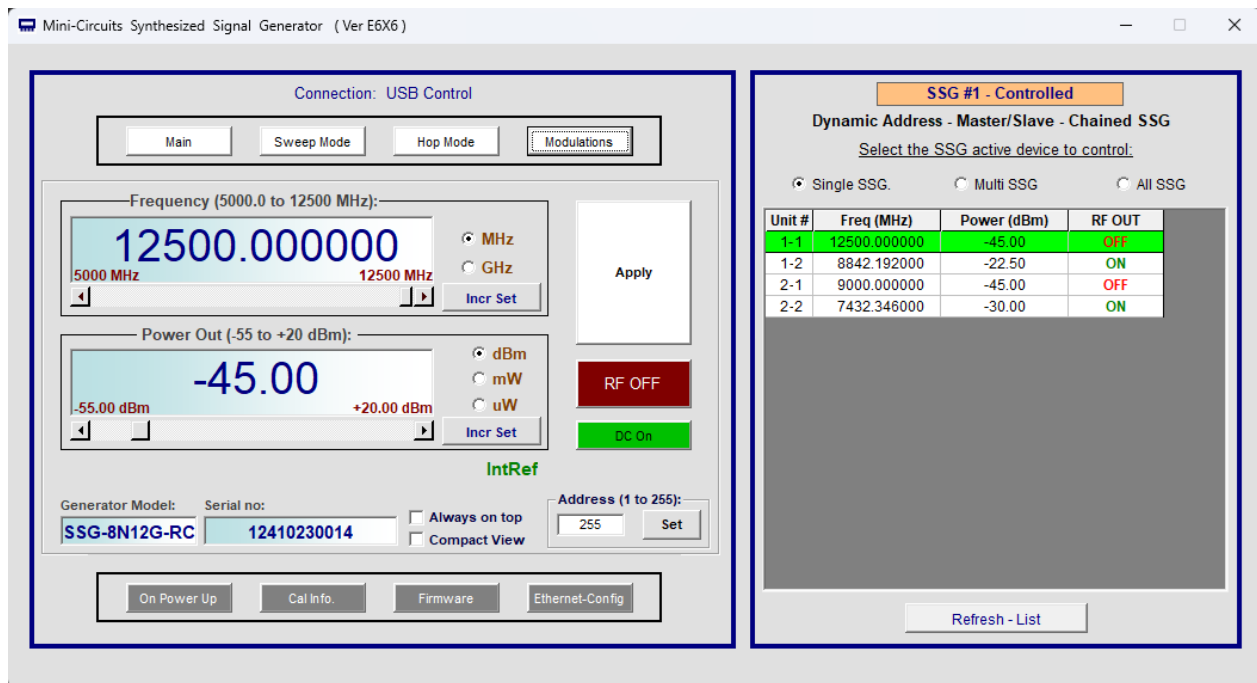



AUTOMATED SWEEP / HOP SEQUENCES

- Set all functions for each channel independently
- Sweep across a frequency band at a fixed output power.
- Sweep output power levels at a fixed frequency.
- Hop through a list of pre-defined frequency / power settings.
- Set dwell times down to 10 μs in high speed mode.
- Run on demand or in response to external triggers.
- Produce triggers to signal switching points or completing a run.

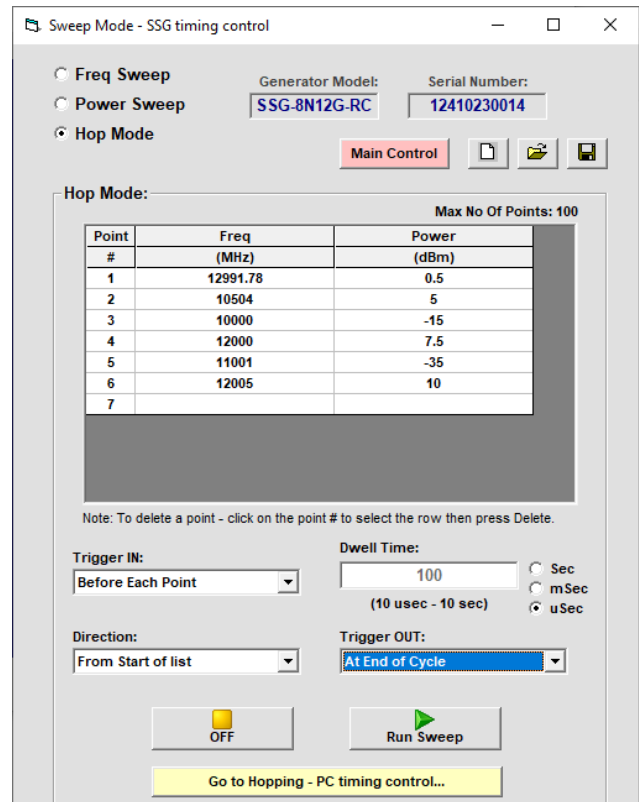

MODULATION

- Select AM, FM, Chirp or Pulse modulation
- In the individual screens for each modulation specify the parameters for the modulated signal

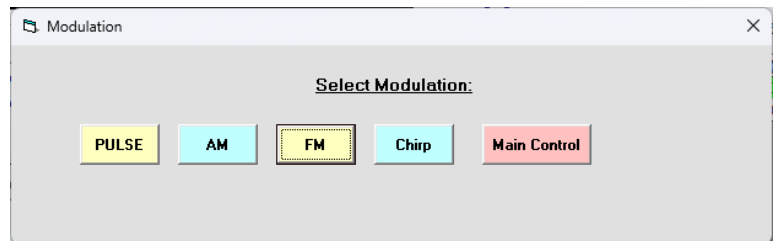



DYNAMIC PULSE MODULATION

- Configure repetitive pulsed output sequences.
- Define custom pulse lists with a different frequency, power, width & interval at each step.
- Set pulse widths down to 0.5 us.
- Run continuously or for a preset number of cycles.

S/N: 12309070010 - Pulse Mode

Pulse Source:

- Free Run
- Triggered
- Square
- Ext. Pulse Mod.

Dynamic Pulse Mode:

Pulse #	RF Freq (MHz)	RF Power (dBm)	P.Width (usec)	Interval (usec)
1	9100	0	45000	500
2	9150	-5	5000	500
3	9590	-10	1	500
4	9990	-19	0.5	500
5	10050	-19	1	500
6	10000	-19	1	500
7	12000	-25	5	900
8	11555	5	5	900
9	12000.0001	5	10	900
10	12400	5	55	900
11	12500	10	5	900
12	12300	10	2	900
13	12400	10	1	900

Notes: Min Pulse Width is 0.5 usec, Min interval is: 7 usec (fix Freq) or 400 usec. Max number of lines is: 100

To remove a line - click on the line # to select then press Delete.

Run continuously

Number of Cycles:

FREQUENCY MODULATION (FM)

- Set carrier power and frequency.
- Set modulating signal frequency.
- Set desired FM deviation.
- Select Sine or triangle wave modulating signal.

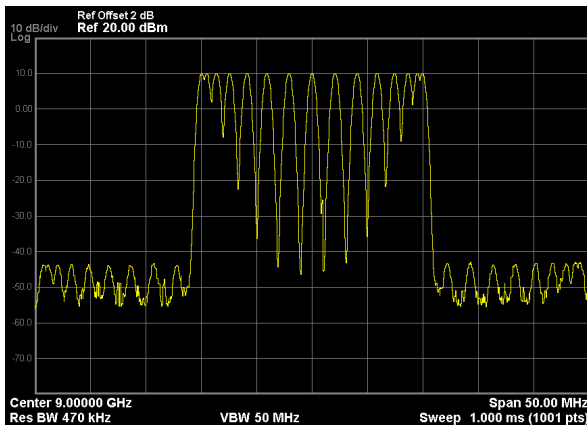

Modulation

Select Modulation:

-
-
-
-
-

FM Modulation:

Carrier

Frequency (MHz):

Power Level (dBm):

FM

FM Frequency (Hz):

FM Deviation (kHz):
(Max: 50000 kHz)

FM Function:



CONNECTING MULTIPLE MODULES (DAISY CHAIN)

The model is designed to connect up to 25 modules in series (daisy chain) using dynamic addressing, meaning there is no need to specifically set the address of the modules. The addresses will be set automatically as part of establishing the communications with the computer. The module connected to the computer's USB port or Ethernet connection will be assigned address 0 (master), the first module connected to it will get address 1 (slave) and subsequent modules incrementing up to address 24 (slave).

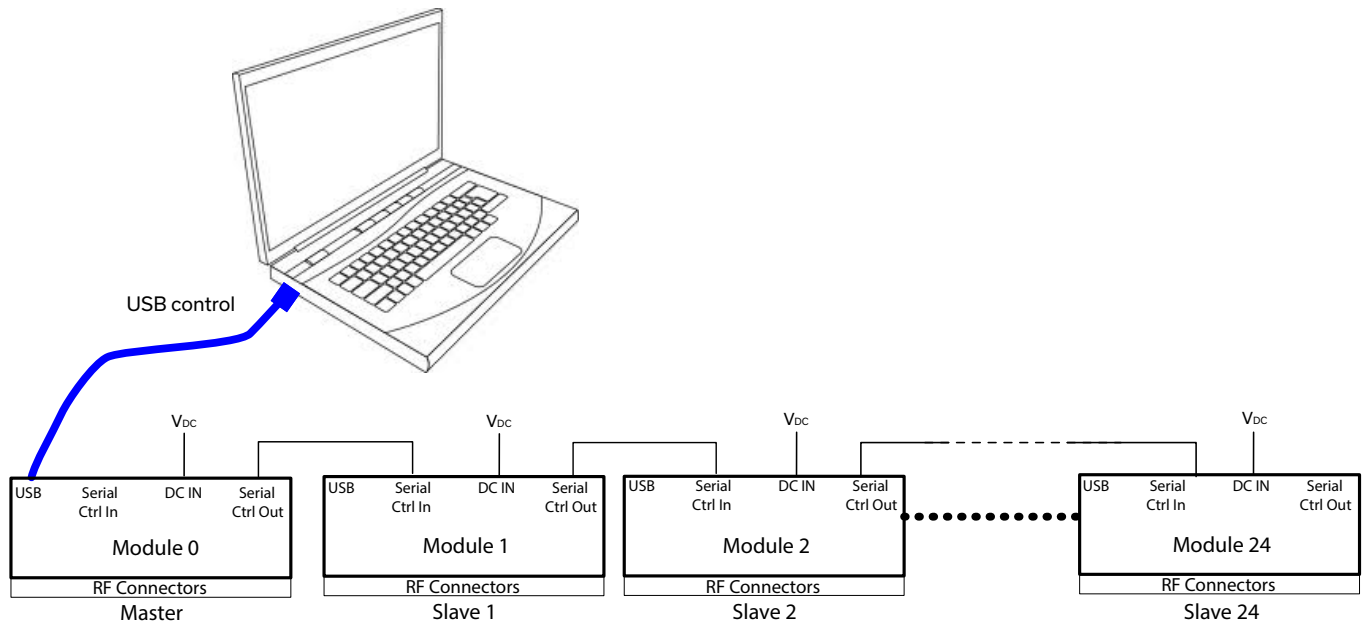

Connections between modules will be made using the serial in/out ports with the module connected to the PC act as a master and all other as slave modules. All control will be through the master module (address 0) which is the only one communicating with the PC or computer network. Serial control out port of each module should be connected to the serial control in port of the next module.

Power must be supplied to each module separately via their individual power supplies.

The serial master/slave bus allows connecting modules of different types to the same daisy chain as long as all support Mini-Circuits Dynamic addressing setup. To add a new module to the setup, simply connect the module and refresh the address listing, no need to reset any of the existing modules or assign addresses manually.



BLOCK DIAGRAM

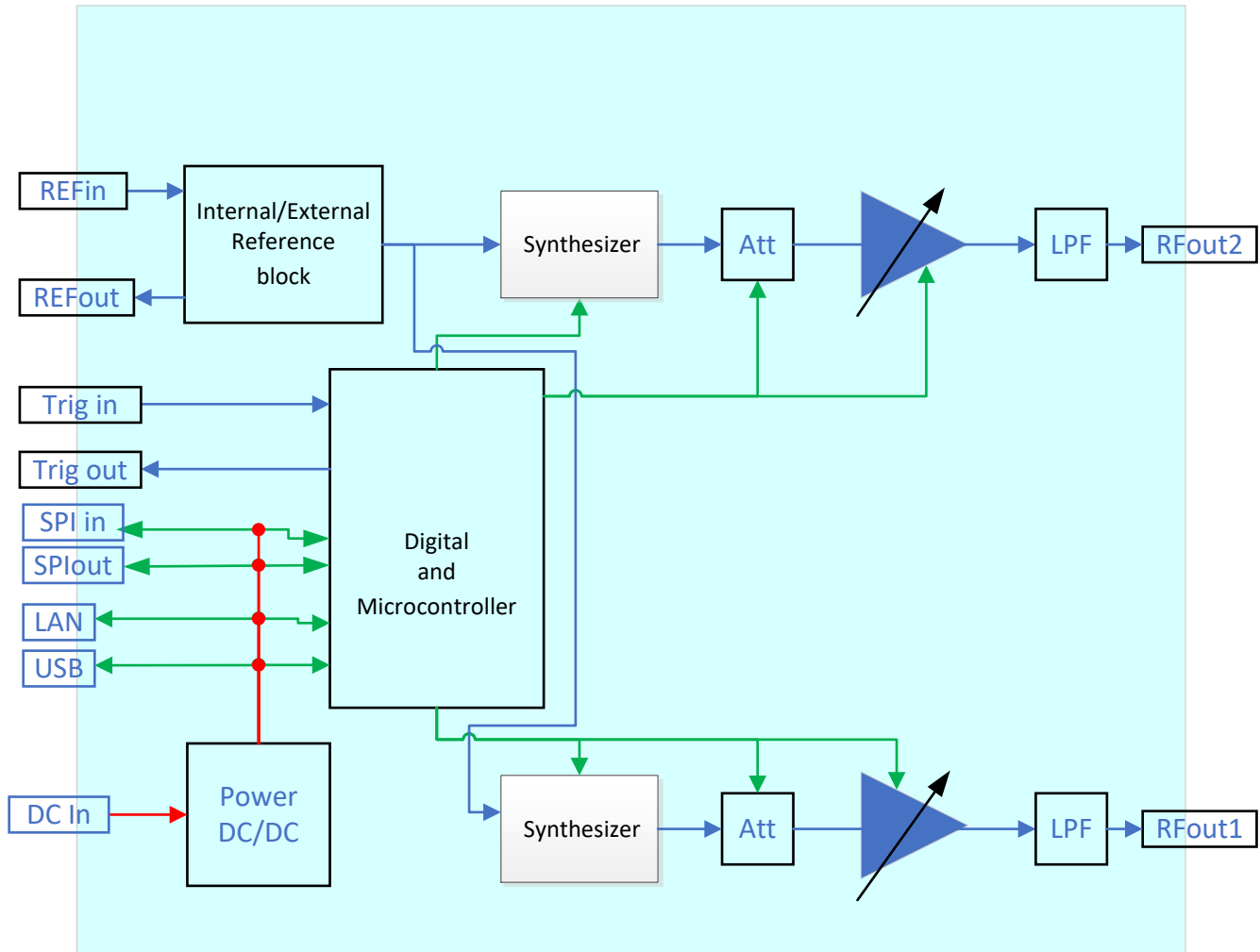

CONNECTIONS

Port Name	Connector Type
RF output (RF1 & RF2)	SMA-Female
Reference in	J4 SMB-Male
Reference out	J5 SMB-Male
Trigger in	J3 SMB-Male
Trigger out	J2 SMB-Male
Power in ¹⁹	2.1 mm DC socket
USB port	USB type C female
Network (Ethernet/LAN)	RJ45 socket
Serial Out (Digital Control 1 port)	Digital Snap Fit Connector ²⁰
Serial In (Digital Control 2 port)	Digital Snap Fit Connector ²⁰

19. No power On/Off switch - SSG will power on as soon as power is connected, starting at the specified startup condition (factory default set to 12.5 GHz, -50 dBm, RF Off).

20. Mating connector is Hirose ST40X-10S-CV(30)



OUTLINE DRAWING (SL3644)

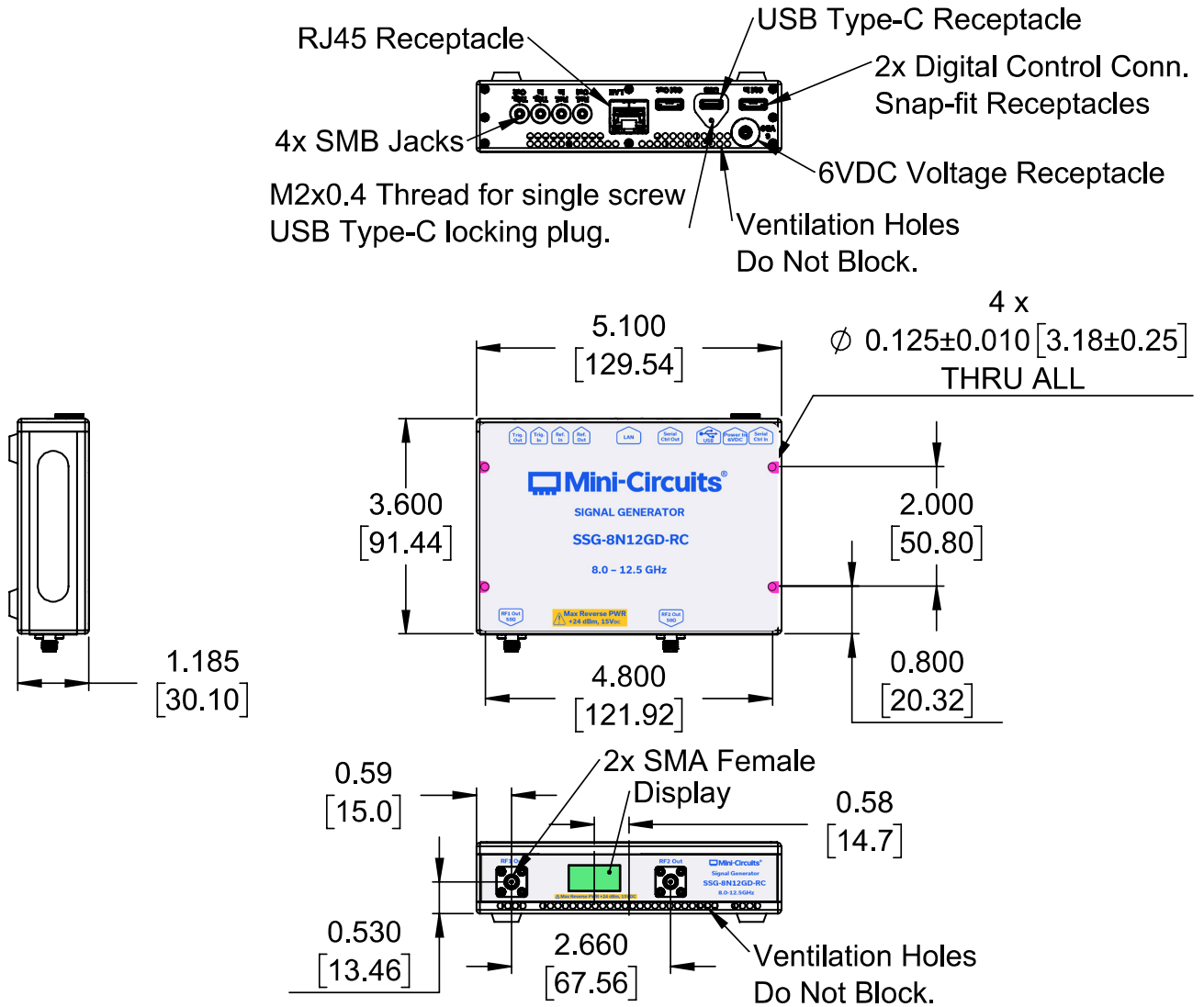

NOTES:

1. Case material: Aluminum alloy.
2. Case Finish: Nickel Plate.
3. Weight: 600 grams
4. Marking may contain other features or characters for internal lot control.

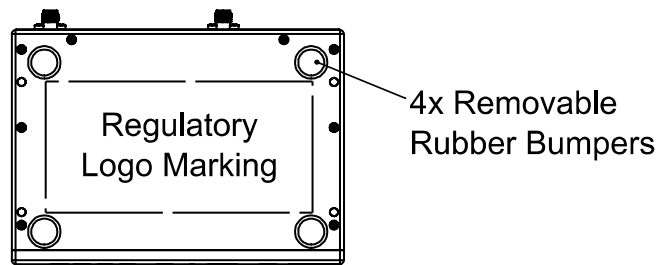



USB & ETHERNET & DAISY-CHAIN

Signal Generator

SSG-8N12GD-RC





50Ω 8 to 12.5 GHz -55 dBm to +23 dBm SMA Female Dual Channel

DETAILED MODEL INFORMATION IS AVAILABLE ON OUR WEBSITE [CLICK HERE](#)

Performance Data & Graphs	Data Graphs
Case Style	SL3644
Environmental Rating	ENV55
Software, User Guide & Programming Manual	https://www.minicircuits.com/softwaredownload/sg.html
Regulatory Compliance	<p>Refer to user guide for compliance information</p>  <p>https://www.minicircuits.com/app/AN49-003.pdf</p>
Support	testsolutions@minicircuits.com

INCLUDED ACCESSORIES ²¹

	Part No.	Description	Qty.
	AC/DC-6-3W	AC/DC Grounded Power adapter, 0°C to +40°C AC Input: 100-240 V, 50/60 Hz, I _{Max} = 1.2A DC Output 6±0.3 V, I _{Max} = 3A	1
(See images below)	CBL-3W-xx	AC Power Cord (Select one power cord from below with each unit)	1
	USB-CBL-AC-7SC+	6.5 ft (2.0 m) USB Cable: USB type A (Male) to USB type C (Male)	1
	CBL-5FT-BMSMB+	5.0 ft (1.5 m) Trigger cable: BNC (Male) to SMB (Female)	2

21. Additional quantities are available for purchase as optional accessories.

AC POWER CORD OPTIONS ²²

United States	Europe	United Kingdom	Australia and China	Israel
				
CBL-3W-US	CBL-3W-EU	CBL-3W-UK	CBL-3W-AU	CBL-3W-IL

22. Select one option from the list with each unit. Please contact testsolutions@minicircuits.com if your region is not listed.





USB & ETHERNET & DAISY-CHAIN





Signal Generator

SSG-8N12GD-RC

Mini-Circuits

50Ω 8 to 12.5 GHz -55 dBm to +23 dBm SMA Female Dual Channel

OPTIONAL ACCESSORIES

	Part No.	Description
	USB-CBL-AC-7SC+ (spare)	6.5 ft (2.0 m) USB Cable: USB type A (Male) to USB type C (Male)
	CBL-5FT-BMSMB+ (spare)	5.0 ft (1.5 m) Trigger cable: BNC (Male) to SMB (Female)
	CBL-RJ45-MM-5+	5.0 ft (1.5 m) Ethernet cable: RJ45 (Male) to RJ45 (Male) Cat 5E cable
	CBL-5FT-MMD+	5.0 ft (1.5 m) Cable assembly for serial control daisy chain with snap fit connectors
	CBL-1.5FT-MMD+	1.5 ft (0.45 m) Cable assembly for serial control daisy chain with snap fit connectors

CALIBRATION

Part No.	Description
CALSSG-8N12GD-RC	Calibration Service for SSG-8N12GD-RC CLICK HERE

NOTES:

- A. Performance and quality attributes and conditions not expressly stated in this specification document are intended to be excluded and do not form a part of this specification document.
- B. Electrical specifications and performance data contained in this specification document are based on Mini-Circuit's applicable established test performance criteria and measurement instructions.
- C. The parts covered by this specification document are subject to Mini-Circuits standard limited warranty and terms and conditions (collectively, "Standard Terms"); Purchasers of this part are entitled to the rights and benefits contained therein. For a full statement of the Standard Terms and the exclusive rights and remedies thereunder, please visit Mini-Circuits' website at <https://www.minicircuits.com/terms/viewterm.html>

