



## COAXIAL SOLID-STATE

# High Power Signal Source

## RFS-G90G93750X+

750W 902 to 928 MHz MCX to 7/16-DIN-Female

### THE BIG DEAL

- High output power, 750W
- 902 to 928MHz ISM band
- Suitable for CW and pulsed signals
- High gain, 59 dB typical
- High efficiency, 63%
- High ruggedness
- Built-in monitoring and protection for temperature, voltage, current, forward, and reflected power
- Includes signal generation (frequency, amplitude, and phase control)
- User friendly USB interface
- Labview™ instrument drivers and Modbus interface available
- Can operate as a stand-alone amplifier

### APPLICATIONS

The RFS-G90G93750X+ module can be used as a building block in any single or multi-channel system for high power RF Energy applications such as:

- Materials processing
- Food processing (heating, tempering, and pasteurization)
- Microwave-assisted chemistry
- Plasma generation
- Plasma surface treatment
- Disinfection/Sterilization
- Chemistry
- Agriculture (pest and bacteria eradication)
- Semiconductor RF generators

### PRODUCT OVERVIEW

The RFS-G90G93750X+ is a new generation solid state connectorized high-power signal source module which can be used in a wide range of industrial, scientific, and medical applications in the 902-928 MHz ISM band. The RFS-G90G93750X+ is a fully programmable, versatile, and flexible RF signal generator. The RFS-G90G93750X+ provides many advantages over traditional magnetrons, such as a longer lifespan, frequency tuning, better frequency stability, precise control of output power, and lower power supply voltage. This rugged high power signal source is capable of providing signals (CW & pulsed) from 2W to 750W output power with built-in monitoring and protection for amplifier temperature, load termination temperature, current, supply voltage, forward power, and reverse power. The RFS-G90G93750X+ includes a signal generator and a phase shifter that can be adapted by the end user to support different types of applications. The RFS-G90G93750X+ can also be used as a stand-alone high-power amplifier including control, monitoring, and protection features.

The high-power signal source (or amplifier when configured as such) has internal shutdown circuitry and integrated protection functions for added reliability under difficult operating conditions, making it virtually impossible to destroy. The basic high-power signal source can be controlled externally through a user-friendly USB interface to monitor forward and reflected power to support dynamic load analysis, temperature monitoring, current monitoring, shutdown alarms, enable/disable the signal source/amplifier, and for resetting protection alarms. Separate temperature monitoring is provided for the RF amplifier section and for the circulator termination load.

Full software support is provided, including a user-friendly GUI application, a comprehensive application programmer interface (API) and programming instructions for both Windows and Linux environments, and a Labview™ instrument driver.



Generic photo used for illustration purposes only

### +RoHS Compliant

The +Suffix identifies RoHS Compliance.  
See our website for methodologies and qualifications



## COAXIAL SOLID-STATE

# High Power Signal Source

## RFS-G90G93750X+

750W 902 to 928 MHz MCX to 7/16-DIN-Female

### KEY FEATURES

Features	Advantages
High CW Power	Supports high power applications for a wide range of industrial, scientific, and medical applications in the 902 – 928 MHz ISM frequency band. Power can be regulated accurately from 2W up to 750W @+25C.
High Gain	When operated as a standalone amplifier the typical gain is 59dB. The RFS-G90G93750X+ can be driven to full output power with commercially available integrated signal generators with a 0dBm output signal.
High Efficiency	The RFS-G90G93750X+ uses high-efficiency state-of-the-art LDMOS technology. This combined with adaptive frequency control enables maximum efficiency in the application.
Built-in protection	The RFS-G90G93750X+ has built-in monitoring and protection for amplifier temperature, load termination temperature, voltage, current, forward power, reverse power, and internal shutdown circuitry for added reliability under difficult operating conditions. When the prestored limits shown in the protection limits table are exceeded the signal source/amplifier will shut down.
Built-in signal generation	Versatile and flexible small signal RF generator specifically designed to control RF Energy applications in the 902 – 928 MHz band.
Ruggedness	The RFS-G90G93750X+ has excellent reverse isolation and ruggedness with an onboard circulator. Reverse power is monitored, and the signal source/amplifier is shut down when the reverse power or load termination temperature exceeds the prestored limits shown in the protection limits table.
Forward & Reverse Power detection	The RFS-G90G93750X+ features integrated couplers and detectors for Forward (FWD) and Reflected (REFL) power detection. FWD and REFL power detection supports reproducible RF power measurements as well as dynamic load analysis and can be used to control or shut off the signal source/amplifier by using internal monitoring or an external controller.
Easy interfacing	Easy access to the RFS-G90G93750X+ through USB interface, enabling dynamic ISM applications with either single or multiple modules to be controlled. Analog outputs for Forward- and Reflected power measurements provide real-time feedback. Digital inputs and outputs permit low-level interfacing to the unit for minimum control overhead implementations.
Small and lightweight	With a small footprint (88mm x 221mm x35mm) and lightweight (0.625kg) the modular design is flexible for single or multiple system integration.
Cooling	The signal source/amplifier can either be air or water-cooled by mounting to a heatsink using the mounting holes available on the module.
Low voltage	The RFS-G90G93750X+ is powered by a low-voltage 50V supply.
Firmware	Integrated powerful microcontroller, capable of accommodating the board control firmware. Calibrated RF power, voltage, current, and temperature measurements. Autogain controller loop. Embedded memory to store calibration data, use-case profiles, modulation patterns, etc. Dedicated USB functions to communicate with connected modules. Powerful embedded functions provide: - fast reflected power sweep across the frequency band (902 – 928 MHz). - reflected power minimum lock + tracker. - pulse width modulation (PWM) for fine-tuned process control. Safe operating area (SOA): Configurable, fast protection algorithms to react to thermal and RF overstress
GUI	Module supported by a dedicated GUI. Supports user-designed application-level software. A comprehensive manual to program and control the RF generator is provided.





## COAXIAL SOLID-STATE

# High Power Signal Source

## RFS-G90G93750X+

750W 902 to 928 MHz MCX to 7/16-DIN-Female

### HIGH POWER SIGNAL SOURCE ELECTRICAL SPECIFICATIONS AT +25°C, 50V, 50Ω SYSTEM, 3.3V LOGIC LEVELS

Parameter	Symbol	Conditions	Min.	Typ.	Max.	Units
Frequency Range	f		902	—	928	MHz
Frequency Resolution	f <sub>RES</sub>	f=902 MHz to 928 MHz	0.5	—	—	MHz
Output Power Setting	P <sub>OUT</sub>	f=902 MHz to 928 MHz	2	—	750	Watts
			33	—	58.75	dBm
Output Power Control Range	P <sub>OUT_CTRL</sub>	f=902 MHz to 928 MHz	26	—	—	dB
Output Power Control Resolution	P <sub>OUT_RES</sub>	f=902 MHz to 928 MHz	—	0.25	—	dB
Output Power Meas. Resolution	P <sub>OUT_MEAS_RES</sub>	f=902 MHz to 928 MHz, @750W P <sub>OUT</sub>	—	0.1	—	dB
Phase Control Range	∅	f=902 MHz to 928 MHz	—	—	360	Deg
Phase Control Resolution	∅ <sub>RES</sub>	f=902 MHz to 928 MHz	—	1	—	Deg
PWM Duty Cycle <sup>1</sup>	PWM-DC	f=902 MHz to 928 MHz	5	—	99	%
PWM Frequency <sup>1</sup>	PWM-Freq	f=902 MHz to 928 MHz	1	—	19.8	kHz
Efficiency	η	f=902 MHz to 928 MHz, @750W P <sub>OUT</sub>	58	63	—	%
Operating Voltage	V <sub>DC</sub>	f=902 MHz to 928 MHz	49	50	51	V
Supply Current	I <sub>DC</sub>	f=902 MHz to 928 MHz, @750W P <sub>OUT</sub>	—	24.0	26.0	A
Amplifier Temperature Sense <sup>4,5</sup> (Based on analog output)	T <sub>FINAL</sub>	T <sub>FINAL</sub> = (-71.7 x TEMP_FINAL_AOUT) + 186 (TEMP_FINAL_AOUT is the analog voltage on pin 21 of the 30 Pin conn., Ctrl1. Temperature can also be read through USB)				°C
Load Temperature Sense <sup>4,5</sup> (Based on analog output)	T <sub>LOAD</sub>	T <sub>LOAD</sub> = (-71.7 x TEMP_FINAL_AOUT) + 186 (TEMP_TERM_AOUT is the analog voltage on pin 19 of the 30 Pin conn., Ctrl1. Temperature can also be read through USB)				°C
Supply Current Measured (Based on analog output)	I <sub>CURRENT</sub>	I <sub>CURRENT</sub> = (10.04 x ISENSE_AOUT) (ISENSE_AOUT is the analog voltage on pin 23 of the 30-pin connector, Ctrl1. Current can also be read through USB)				A
Signal Source On / Off	-	Enable (TTL low, default) / Disable (TTL high) on Pin 24 of the 30-pin connector, Ctrl1.				

### STAND-ALONE HIGH POWER AMPLIFIER ELECTRICAL SPECIFICATIONS AT +25°C, 50V, 50Ω SYSTEM, 3.3V LOGIC LEVELS

Parameter	Symbol	Conditions	Min.	Typ.	Max.	Units
Frequency Range	f		902	—	928	MHz
Input Power	P <sub>IN</sub>	f=902 MHz to 928 MHz	—	0	3	dBm
Output Power	P <sub>OUT</sub>	f=902 MHz to 928 MHz @0dB Atten setting	750	—	See Notes 2 & 3	Watts
			58.75	—	See Notes 2 & 3	dBm
Phase Control Range	∅	f=902 MHz to 928 MHz	0	—	360	Deg
Phase Control Resolution	∅ <sub>RES</sub>	f=902 MHz to 928 MHz	—	1	—	Deg
Power Gain	G <sub>P</sub>	f=902 MHz to 928 MHz @0dB Atten. setting and 750W P <sub>OUT</sub>	57	59	—	dB
Power Gain Flatness	G <sub>FLAT</sub>	f=902 MHz to 928 MHz @0dB Atten. setting and 750W P <sub>OUT</sub>	—	1	2	dB
Efficiency	η	f=902 MHz to 928 MHz @0dB Atten. setting and 750W P <sub>OUT</sub>	58	63	—	%
Input VSWR	I <sub>VSWR</sub>	f=902 MHz to 928 MHz @0dB Atten. setting and 750W P <sub>OUT</sub>	—	1.2	1.35	
Operating Voltage	V <sub>DC</sub>	f=902 MHz to 928 MHz	49	50	51	V
Supply Current	I <sub>DC</sub>	f=902 MHz to 928 MHz @0dB Atten. setting and 750W P <sub>OUT</sub>	—	24.0	26.0	A





# COAXIAL SOLID-STATE

# High Power Signal Source

# RFS-G90G93750X+

750W 902 to 928 MHz MCX to 7/16-DIN-Female

### SAFE OPERATING AREAS AND PROTECTION LIMITS<sup>2</sup>

Parameter	Warning Limits		Shutdown Limits		Units
	Low	High	Low	High	
Amplifier Temperature Sense <sup>4</sup>	—	60	—	65	°C
Termination Temperature Sense <sup>5</sup>	—	80	—	85	°C
Forward Power	—	775	—	800	Watts
	—	58.89	—	59.03	dBm
Reverse Power	—	750	—	775	Watts
	—	58.75	—	58.89	dBm
Voltage Supply	49	51	48	52	V
Current Supply	—	26.5	—	27	A

### ABSOLUTE MAXIMUM RATINGS<sup>3</sup>

Parameter	Ratings
Amplifier Operating Temperature <sup>4</sup>	0°C to +65°C
Termination Operating Temperature <sup>5</sup>	0°C to +85°C
Storage Temperature	-20°C to +85°C
DC Voltage	52V
Input RF Power	5 dBm
Forward Output Power	800W
Power into the RF output connector	775W
Current Supply	27 A

- To ensure accurate power readings (and therefore accurate power output), the minimum value of the duty cycle changes along with the PWM frequency. See the PWM section for more details.
- There are two reactions to excessive operation depending on severity. If the parameter reaches a level that is high but still tolerable a warning error will be raised. If the parameter is dangerously high and exceeds the prestored limits the module will be shut down and remain disabled until a reset command is sent through the USB interface or by applying a logic high level to pin 5 of the multi-pin connectors, Ctrl1.
- RFS-G90G93750X+ may operate up to these maximum ratings with no damage, permanent damage may occur if any of these limits are exceeded.
- This is the sensed amplifier operating temperature calculated from the analog output, TEMP\_FINAL\_AOUT, or read through USB from the RFS-G90G93750X+. There is an offset from the temperature measured at the temp. sense location to the module pallet base of approximately +20 to 30°C. I.e. When the internal sensed temperature read from the module is +55°C, then the temperature at the base of the pallet is approximately +75-85°C.
- This is the sensed load termination operating temperature calculated from the analog output, TEMP\_TERM\_AOUT, or read through USB from the RFS-G90G93750X+.

### BLOCK DIAGRAM

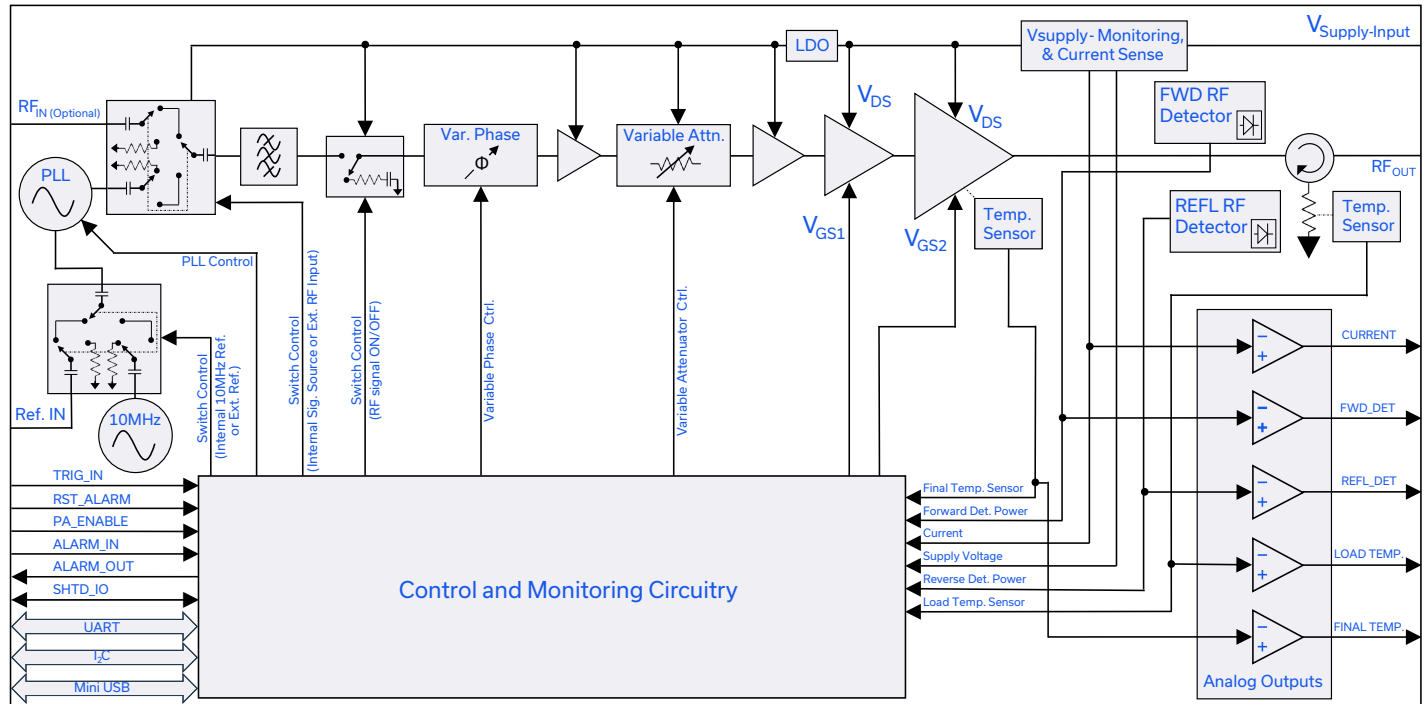



TYPICAL PERFORMANCE DATA FOR AMPLIFIER MODE (50V, 50Ω SYSTEM)

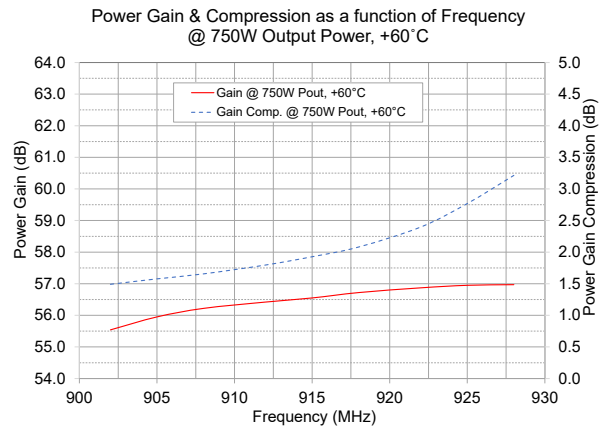
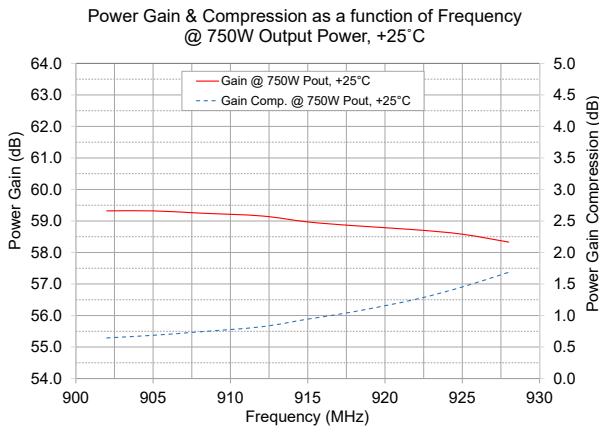
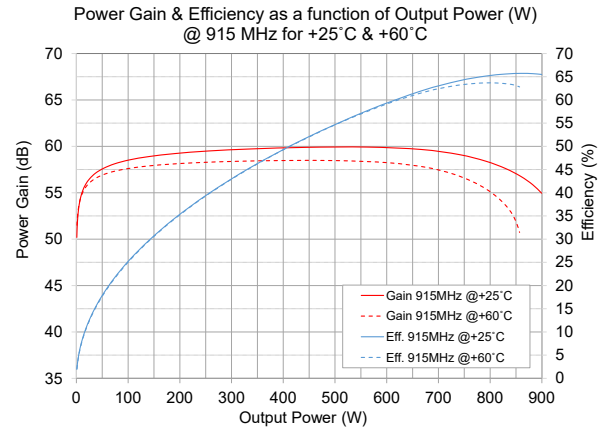
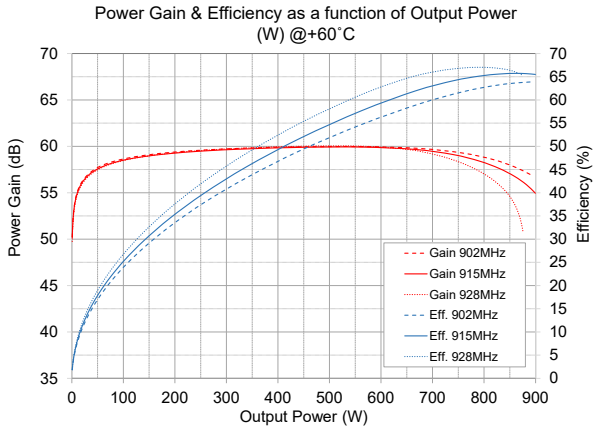
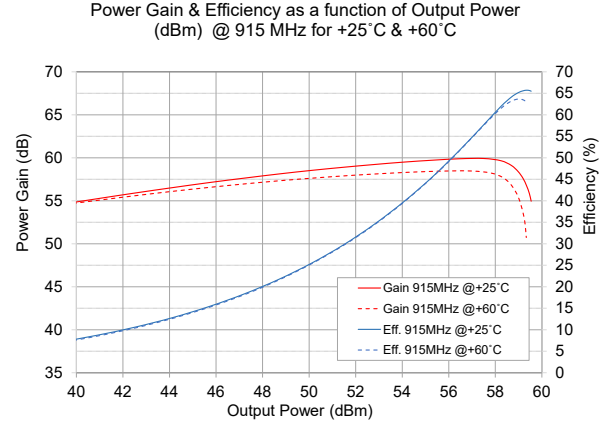
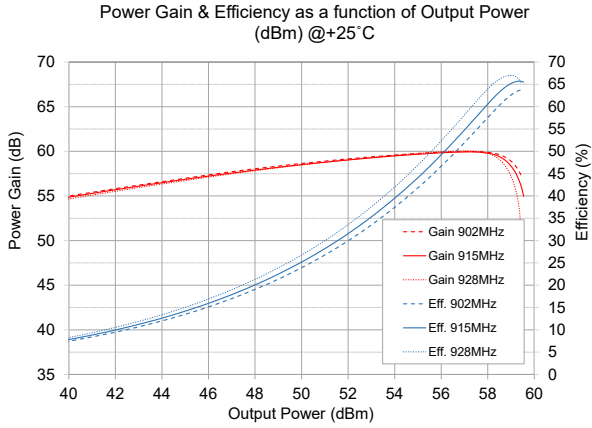



### TYPICAL PERFORMANCE DATA FOR AMPLIFIER MODE (50V, 50Ω SYSTEM)

Efficiency as a function of Frequency with fixed Output Power @ +25 °C

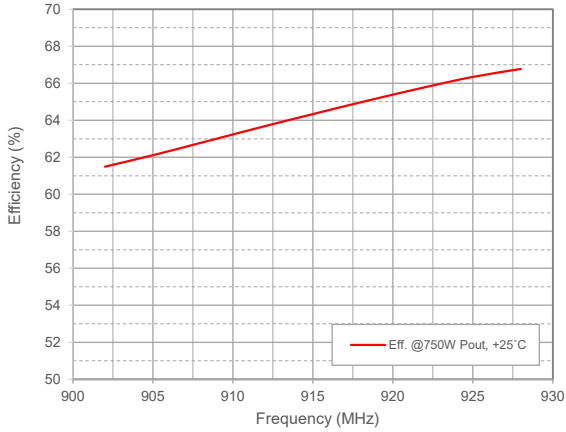

Efficiency as a function of Frequency with fixed Output Power @ +60 °C

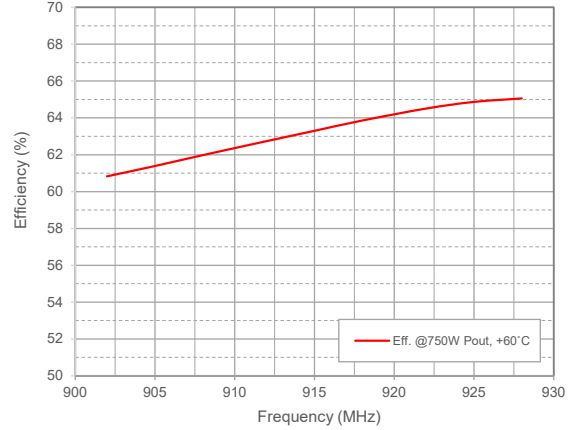

FWD\_AOUT (forward power analog output voltage) as a function of Output Power @ +25 °C

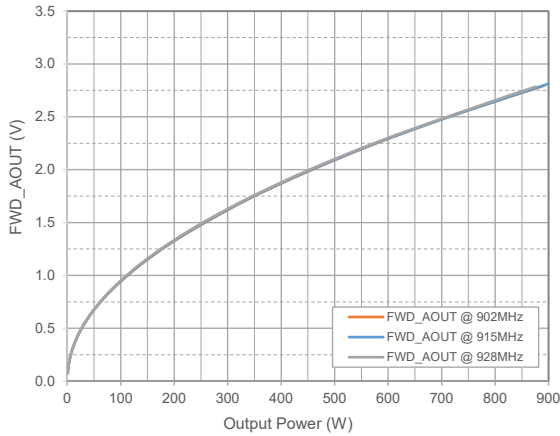

REFL\_AOUT (reflected power analog output voltage) as a function of Power into the RFout Connector @ +25 °C

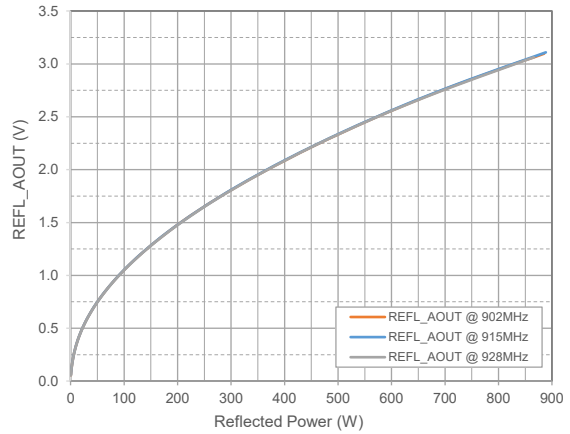



### HEATSINK REQUIREMENTS

Depending on the end system design or architecture, either water or air cooling must be used to regulate the RFS-G90G93750X+ module's temperature. In order to provide the user with the flexibility to decide on the cooling type, Mini-Circuits provides the RFS-G90G93750X+ without a heat sink and the user decides what type of cooling they want to use. It is critical that the amplifier is always mounted to a heatsink where the airflow of a fan on an air-cooled heat sink or the water temperature and flow rate of a water-cooled heatsink is set to keep the amplifier below 60°C at full RF power when operating, otherwise, the amplifier will get too warm, the built-in protection alarms will be activated and the power amplifier will shut itself down. The Application note, AN-tbd, describes how to mount the RFS-G90G93750X+ to a Mini-Circuits air-cooled heatsink (HSK-G90G93750X+). This is a heat sink that is designed specifically for the RFS-G90G93750X+ module and is also available through the Mini-Circuits website.

### APPLICATION OVERVIEW

The RFS-G90G93750X+ can operate as a standalone RF power generator when connected to a DC power supply and mounted to a heat sink. The high-power signal source is ready to deliver RF power to any applicator, i.e., a "device" to contain and/or apply the RF energy. The use of the latest generation solid state devices guarantees high efficiency, long lifetime, and fully controllable and stable output power in a compact module outline. The module has built-in monitoring and protection for amplifier temperature, load termination temperature, current, supply voltage, forward power, reverse power, and internal shutdown circuitry for added reliability under difficult operating conditions, making it virtually impossible to destroy in single and multi-channel systems due to the integrated circulator and protection functions. When the prestored limits shown in the protection limits table are exceeded the module will shut down and remain disabled until an alarm reset is sent either by command via USB or a TTL high applied to pin 26 of the multi-pin connector, Ctrl1. For advanced mode, users may consult the factory for more in-depth control commands and protection overrides. The RFS-G90G93750X+ can operate in both CW and PWM modes. When operating in PWM mode, a minimum of six 1000uF or three 2200uF electrolytic capacitors should be used and located on the DC power supply line close to the amplifier supply terminals in parallel with the +50V supply to ground. These capacitors will increase the reliability of the amplifier in PWM mode and improve the RF waveform overshoot and ripple in the pulse.

### OPERATION MODE

There are two operation modes supported by the RFS-G90G93750X+ when configured as either an RF signal source or a stand-alone amplifier.

#### 1. STANDARD OPERATION MODE (STDOM)

- Signal source/amplifier Enable/Disable.
- Ability to set output power level, frequency, and phase.
- Built-in protection features enabled.
- Ability to reset protection shutdown via USB command or logic high on pin 5 of the multi-pin connector, Ctrl1.
- Access to analog outputs for temperatures, forward power, reverse power, and current that can be correlated to output power.
- Access through USB to read Temperatures (°C), forward power (dBm or W), reverse power (dBm or W), supply voltage (V), and current (A).

#### 2. ADVANCED OPERATION MODE (ADVOM)

- All the "standard operation mode" features are available.
- Access to enable/disable internal protection shutdown or change prestored internal shutdown limits (warranty is no longer valid in this situation).
- Access to all digital data for forward detected power, reverse detected power, temperatures, supply voltage, and current.
- With either mode, the external analog, digital signals, and control logic can optimize the RF vector (frequency, power, and time) depending on the application's needs in real-time.





### CASE STYLE DRAWING

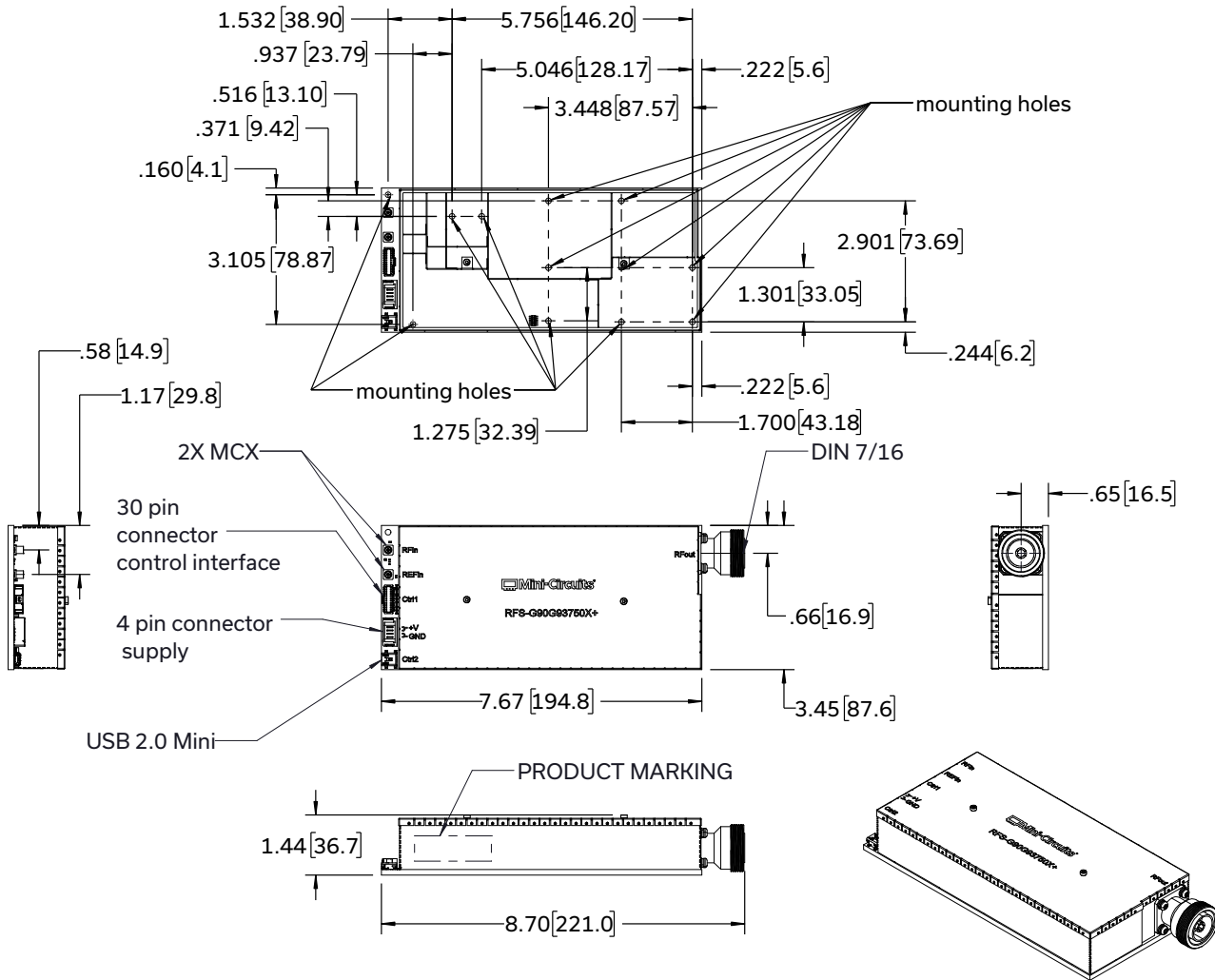

Weight: 200 grams

Dimensions are in inches [mm]. Tolerances: 2 Pl. ±0.03 inch; 3 Pl. ± 0.015 inch

### PRODUCT MARKING\*: RFS-G90G93750X+

\*Marking may contain other features or characters for internal lot control

#### Notes:

1. Case Material/Finish: Nickel Silver Shield and Cover. ENIG finish on the bottom of PCB.
2. Shield cover requires temporary removal to install mounting screws.
3. M3 SHCS (DIN 912, ISO 21269) Screws recommended for mounting.
4. 1.5nM (13lbf in) Max. Torque is recommended for mounting screws.





## COAXIAL SOLID-STATE

# High Power Signal Source

## RFS-G90G93750X+

Mini-Circuits

750W 902 to 928 MHz MCX to 7/16-DIN-Female

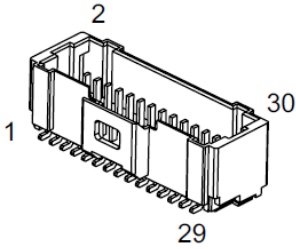

### RFS-G90G93750X+ CONTROL INTERFACE PIN OUT AND FUNCTIONALITY

Pin Number	Label	Functionality and Control
1, 4, 5, 8, 9, 12, 13, 16, 25, 28	GND	Ground
2	Do Not Connect	Reserved pin for the manufacturer.
3	Do Not Connect	Reserved pin for the manufacturer.
6	Do Not Connect	Reserved pin for the manufacturer.
7	Do Not Connect	Reserved pin for the manufacturer.
10	Do Not Connect	Reserved pin for the manufacturer.
11	Do Not Connect	Reserved pin for the manufacturer.
14	Do Not Connect	Reserved pin for the manufacturer.
15	Do Not Connect	Reserved pin for the manufacturer.
17	SHTD_IO	This pin is similar to using the ALARM_IN and ALARM_OUT connected in a daisy-chain configuration with other modules except SHTD_IO is intended as a bidirectional bus line. In a system with multiple RFS-G90G93750X+ modules, all SHTD_IO lines can be connected. This pin is normally high and any unit connected can signal an error state by pulling this pin low. Other modules would observe SHTD_IO being asserted, shut down, and produce an alarm out.
18	ALARM_OUT	When the protection limits are exceeded and the module is shut down, this pin will go from normally TTL low to TTL high. This output signal can be used by an external controller to adjust operating conditions or shut down the system. It can be connected to other RFS-G90G93750X+ modules in a system in a daisy chain configuration ALARM_OUT, pin18 of Ctrl1, to ALARM_IN, pin 22 of Ctrl1 to shut down all modules when there is a shutdown error present.
19	TEMP_TERM_AOUT	Analog voltage (0 to 3.3V) that can be correlated to the circulator's termination load temperature. See the equation in the electrical specification table.
20	Do Not Connect	Reserved pin for the manufacturer.
21	TEMP_FINAL_AOUT	Analog voltage (0 to 3.3V) that can be correlated to the final stage transistor temperature. See the equation in the electrical specification table.
22	ALARM_IN	This input can be connected to a system controller to shut down the module or can be connected to other RFS-G90G93750X+ modules in a system in a daisy chain configuration ALARM_OUT, pin18 of Ctrl1, to ALARM_IN, pin 22 of Ctrl1 to shut down all modules when there is a shutdown error present. This pin is normally low and can be set to a TTL high to shut down the module.
23	ISENSE_AOUT	Analog voltage (0 to 3.3V) that correlates to the signal source/amplifier current level
24	PA_ENABLE	Enable (TTL low) / Disable (TTL high). Normally low, enabled, and can be disabled when a TTL high is applied.
26	RST_ALARM	Reset Alarm - Internal protection shutdown can be reset through USB communication or applying a TTL high to this pin.
27	FWD_AOUT	Analog voltage (0 to 3.3V) that can be correlated to the level of the forward output power.
29	REFL_AOUT	Analog voltage (0 to 3.3V) that can be correlated to the level of the reflected power or power incident at the RFout connector.
30	TRIG_IN	Used during externally supplied pulse mode operation. Automated gain control is disabled in this operating mode.

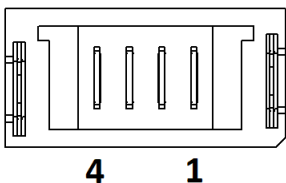

### DC POWER SUPPLY PIN OUT AND FUNCTIONALITY

Pin Number	Label	Functionality and Control
1, 2	GND	Ground (Pin closest to the USB connector)
3, 4	+V	+50V DC Supply Voltage Input



## COAXIAL SOLID-STATE



# High Power Signal Source

## RFS-G90G93750X+

Mini-Circuits

750W 902 to 928 MHz MCX to 7/16-DIN-Female

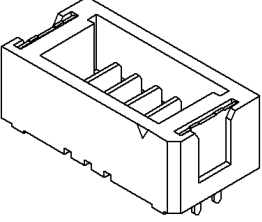
### RFS-G90G93750X+ INTERFACES AND SUGGESTED MATING HARDWARE\*

	<p>RFIN - MCX Connector Jack, Female Socket 50 Ohm (Molex P/N 73415-1692)  Mating Cable: SMA female-MCX RA Male 12", Mini-Circuits Cable P/N FL86-12SMMCR+</p>
	<p>+V and GND - DC Supply Connector, 4-pin pluggable terminal block  (Samtec P/N UMPT-04-02.5-L-V-S-W-M-TR)  Mating connector: Samtec P/N UMPC-04-L-16-M-12.0, 4 wires cable assembly, socket.</p>
	<p>Ctrl1 - Control Connector, 30 Pin (Molex 203564-3017)  Mating connector shell: Molex 501189-3010, and wires with pre-crimped leads,  Molex 79758-1018 or 79758-1019.</p>
	<p>Ctrl2 - Control Connector, Mini USB Type AB, USB 2.0, Receptacle, 5 Position  (Samtec P/N MUSB-05-S-AB-SM-A)</p> <p>Mating Cable:  USB Type A to type Mini B Plug 2.69FT. Mini-Circuits P/N: MUSB-CBL-3+  USB Type A to type Mini B Plug 6.86FT. Mini-Circuits P/N: MUSB-CBL-7+</p>
	<p>Output connector 7/16 DIN female  The recommended Torque for a stainless steel 7/16 DIN connector mate is 2.26 N-m (20 in-lbs)  for lab testing and 25 N-m (221 in-lbs) for final installation.</p>

\*Mating hardware not included with the RFS-G90G93750X+. Similar mating hardware available from other manufactures.



## COAXIAL SOLID-STATE

# High Power Signal Source

## RFS-G90G93750X+

750W 902 to 928 MHz MCX to 7/16-DIN-Female

### SOFTWARE & DOCUMENTATION DOWNLOAD

Full software support is provided, including a user-friendly GUI application, a comprehensive application programmer interface (API) and programming instructions for both Windows and Linux environments, and a Labview™ instrument driver. The latest version of the full software package can be downloaded from [www.minicircuits.com/softwaredownload/RF-Energy-software\\_download.html](http://www.minicircuits.com/softwaredownload/RF-Energy-software_download.html) at any time. Further support documentation is available from the model dashboard page. (url: <https://www.minicircuits.com/WebStore/dashboard.html?model=RFS-G90G93750X%2B>)

### MINIMUM SYSTEM REQUIREMENTS

Parameter	Requirements	
System Requirements	GUI Windows	Windows 7 or newer
	GUI Linux	Raspberry Pi 3 hardware; USB, Ethernet (for GUI's remote command mode); operating system: Raspbian Stretch or newer.
		Operation system ≥ Debian 9 or similar

### GRAPHICAL USER INTERFACE (GUI) KEY FEATURES

- Control of signal source operation
- Set frequency and output power
- Configure generator state at start-up
- Perform S11 sweep and display frequency response.
- Track optimum S11 frequency in real time (DLL routine)
- CW & Pulse width modulation signals
- Forward and reflected power tracking real time

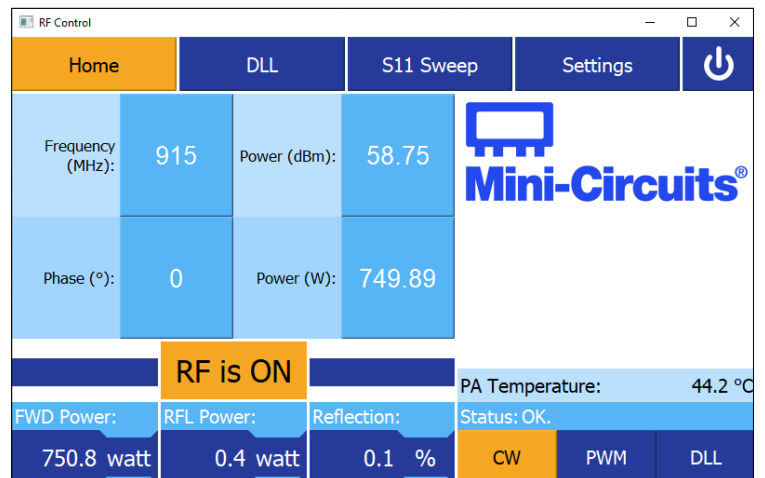

### APPLICATION PROGRAMMING INTERFACE (API) SUPPORT

Application programmer's interface (API) implemented through plain-text command language.

### CONTROL AND BASIC COMMANDS

The RFS-G90G93750X+ supports USB-based communication. Once the module is connected to a Windows™ or Linux™ computer, the generator will appear as virtual com-port and be usable as UART (universal asynchronous receive and transmit interface). Baud rate is 115200, no parity, 1 stop bit. Further support documentation can be found in the application notes AN-50-009 Quick Start Guide, AN-50-010 Programming Manual, AN-50-011 Safe Operation Area, AN-50-005 Digital Locked Loop, AN-50-005 Guidelines on how to interface with Programmable Logic Controllers, AN-50-012 GUI User Manual, and AN-50-013 Quick Start Companion.





### SIGNAL SOURCE

When the RFS-G90G93750X+ is powered ON, the default configuration will be as a signal source with the input select switch set to the internal VCO, VCO off, Freq. -915MHz, the internal attenuator set to 31.75dB, and PA Enable OFF. Using the basic commands listed below or connecting and opening the Graphical USER Interface (GUI) application the frequency and output power can be set, an S11 sweep can be performed to find the frequency with the minimum reflected power from the applicator, and the DLL function can be used to locate and track the minimum reflected power point. The complete guide to optimizing the signal source is described in the supporting documentation application notes.

### \$FCS – SET SIGNAL SOURCE FREQUENCY

This command sets the frequency of the signal source in MHz.

Syntax:

<b>Input</b>	\$FCS,[channel],[frequency]
<b>Output</b>	\$FCS,[channel],OK

- [channel] – Channel identification number.
- [frequency] – The desired frequency setting for the RF signal in MHz.

Example:

<b>Input</b>	\$FCS,1,915
<b>Output</b>	\$FCS,1, OK

This sets the frequency to 915 MHz

### \$PWRS – SET SIGNAL SOURCE OUTPUT POWER SETPOINT IN WATT

This command sets the signal source output to the desired level in Watt

Syntax:

<b>Input</b>	\$PWRS,[channel],[power watt]
<b>Output</b>	\$PWRS,[channel],OK

- [channel] – Channel identification number.
- [frequency] – The desired power level for the RF signal in Watt.

Example:

<b>Input</b>	\$PWRS,1,750
<b>Output</b>	\$PWRS,1, OK

This sets the output power setpoint to 750W.

### \$ECS – ENABLE/DISABLE

This command enables and disables the signal source on and off.

Syntax:

<b>Input</b>	\$ECS,[channel],[Enable/Disable]
<b>Output</b>	\$ECS,[channel],OK

- [channel] – Channel identification number.
- [Enable/Disable] – 1 for enable and 0 for disable.

Example:

<b>Input</b>	\$ECS,1,1
<b>Output</b>	\$ECS,1,OK

This enables the signal source on.



### STAND-ALONE POWER AMPLIFIER

The module can be configured as a stand-alone power amplifier using the \$RFSS command shown below which sets the input select switch to the external RF input, the internal VCO will be set to OFF, the internal digital attenuator will be set to 0dB, and the PA Enable will be ON. The internal attenuation level can be set using the \$GCS command and the PA can be enabled and disabled using the \$ECS command. Forward & Reflected Power1, Current, Voltage, and Temperatures can be read from the RFS-G90G93750X+ using the commands described in the application note AN50-xxx Programming Manual. Note, that not all the commands will apply when using the module as a stand-alone amplifier.

1. The internal forward and reflected power detector readings are calibrated over frequency. To ensure the best possible accuracy on forward and reflected power readouts, it is important to set the frequency of the amplifier to the frequency of the signal supplied to amplifier input using the GUI or \$FCS command.

### \$RFSS – SET MODULE TO STAND-ALONE AMPLIFIER CONFIGURATION

This command will allow the module to switch from the default Signal Source configuration to the Stand-Alone Amplifier Configuration.

#### Syntax:

<b>Input</b>	\$RFSS,[channel],[source]
<b>Output</b>	\$RFSS,[channel],OK

- [channel] – Channel identification number.
- [source] – 0 for internal VCO and 1 for external RF input

#### Example:

<b>Input</b>	\$RFSS ,1,1
<b>Output</b>	\$RFSS ,1,OK

This sets the module to the Stand-Alone Amplifier configuration with external RF input.

#### Example:

<b>Input</b>	\$RFSS ,1,0
<b>Output</b>	\$RFSS ,1,OK

This sets the module back to the internal Signal Source configuration.



### PULSE WIDTH MODULATION (PWM) OPERATION

The RFS-G90G93750X+ has the capability to produce a PWM signal when configured as a signal source. It also can read the forward power and reflected power during the pulse when configured as a signal source or when configured as a stand-alone PA using an external PWM input signal.

When configured as a signal source the module can generate a modulated signal with no external RF or trigger inputs. However, the internal RF signal source can be modulated with an external trigger, TRIG\_IN, on pin 30 of Ctrl1 using the \$ETS command to enable this feature. When configured as a stand-alone amplifier with an external PWM RF input signal a trigger, TRIG\_IN, is required on pin 30 of Ctrl1 to accurately read the forward and reflect power during the pulse. This feature is enabled using the \$ETSS command. More details of these and additional PWM commands can be found in the application note AN-50-xxx Programming Manual.

Pulse Width Modulation allows the user to modulate the RF signal, and in turn the average power output of the system, by turning the signal ON and OFF at a set rate.

The following two parameters are used to achieve this:

- PWM frequency – Dictates how often the signal switches between ON and OFF.
- PWM duty cycle – Dictates the time ratio between ON and OFF each period.

Depending on the duty cycle, the average power output of the system will decrease to a percentage of its set output. For example, a 50% duty cycle at 750W results in an average RF power output of 375W. To ensure sufficient measurement time of the RF signal, the pulses generated by any PWM scheme must not be too short. Hence, the permissible PWM frequency and duty cycle are dependent on each other. The PWM frequency can vary between 1000 Hz – 19800Hz. To ensure accurate power readings (and therefore accurate power output), the minimum value of the duty cycle changes along with the PWM frequency according to the following formula:

$$DC_{min} = ROUNDUP (f_{PWM} * T_{min \text{ pulse width}}/10,000)$$

Where:

- DCmin is the minimum duty cycle as a percentage.
- fPWM is the PWM frequency between 1000 and 19800 Hz.
- Tmin pulse width is the minimum pulse length in microseconds. The minimum pulse width to ensure sufficient measurement time of the RF signal is 50µs.

This means that at 1000 Hz, the minimum duty cycle is 5% and at 19800 Hz it is 99%. Going over this frequency value would effectively disable PWM, as the minimum duty cycle becomes 100%. The user needs to keep these limitations in mind – the system will not check for the limits. For a reasonable control range, PWM frequencies between 1 and 2 kHz are recommended.

### BASIC COMMANDS FOR PWM OPERATION IN SIGNAL SOURCE MODE

#### \$DCS - SET PWM DUTY CYCLE

This command sets the PWM duty cycle between 0% and 100%.

Note: This command doubles as a PWM ON/OFF switch. Setting the duty cycle to 100% is the same as turning PWM off entirely, thus there is no dedicated PWM ON/OFF command.

Syntax:

<b>Input</b>	\$DCS,[channel],[duty cycle]
<b>Output</b>	\$DCS,[channel],OK

- [channel] – Channel identification number.
- [duty cycle] – A value between 0 and 100 that sets the duty cycle in percent. (default = 100%)

Example:

<b>Input</b>	\$DCS,1,50
<b>Output</b>	\$DCS,1,OK

This sets the PWM duty cycle to 50%.

Please note that the usable PWM frequency range in connection with the duty cycle parameter is limited to allow a minimum pulse width needed for proper functioning of the autogain functionality as described above.



### \$DCFS - SET PWM FREQUENCY

This command sets the frequency of the PWM signal.

#### Syntax:

<b>Input</b>	\$DCFS,[channel],[frequency], [reserved]
<b>Output</b>	\$DCFS,[channel],OK

- [channel] – Channel identification number.
- [frequency] – PWM frequency in Hz.
- [reserved] – Reserved. This parameter should only be written 0.

#### Example:

<b>Input</b>	\$DCFS,1,1200,0
<b>Output</b>	\$DCFS,1,OK

This sets the PWM frequency to 1200 Hz.

### \$DCG - GET ALL PWM SETTINGS

This command returns all the settings related to PWM

#### Syntax:

<b>Input</b>	\$DCG,[channel]
<b>Output</b>	\$DCG,[channel],[frequency],[correction factor],[trigger mode],[reserved],[reserved],[reserved],[reserved],[delay],[duty cycle]

- [channel] – Channel identification number.
- [frequency] – The current PWM frequency in Hz.
- [correction factor] – The current correction factor for the PWM signal.
- [trigger mode] – The current operational mode of the PWM triggering.
  - 1 – Free running
  - 2 – Reserved. Parameter should be ignored.
  - 3 – Reserved. Parameter should be ignored.
- [Reserved] – Reserved. The parameter should be ignored.
- [Reserved] – Reserved. The parameter should be ignored.
- [Reserved] – Reserved. The parameter should be ignored.
- [Reserved] – Reserved. The parameter should be ignored.
- [delay] – The current percentage-based delay of the PWM signal.
- [duty cycle] – The current duty cycle percentage value
- [channel] – Channel identification number.
- [frequency] – The current PWM frequency in Hz.

#### Example:

<b>Input</b>	\$DCG,1
<b>Output</b>	\$DCG,1,1200,0,1,255,255,255,255,0.00 0000,50

This indicates that the operational mode is configured to 'free running,' the PWM signal is configured to a frequency of 1200Hz with a duty cycle of 50% and there is no correction factor and no delay





COAXIAL SOLID-STATE

# High Power Signal Source

**RFS-G90G93750X+**

750W 902 to 928 MHz MCX to 7/16-DIN-Female

**ADDITIONAL INFORMATION IS AVAILABLE ON OUR DASHBOARD.**

Performance Data & Graphs	Data
	Graphs
RoHS Status	Compliant
Environmental Ratings	ENV23T32
Export Information	ECCN# EAR99

**ORDERING INFORMATION**

Model No. Links	<a href="#">RFS-G90G93750X+</a>
Product Marking	RFS-G90G93750X+
Case Style	VU3577
Connector	Connector MCX to 7/16 DIN-Female





## COAXIAL SOLID-STATE

# High Power Signal Source

## RFS-G90G93750X+

750W 902 to 928 MHz MCX to 7/16-DIN-Female

### SAFETY INSTRUCTIONS.

**WARNING: FAILURE TO FOLLOW THESE INSTRUCTIONS MAY RESULT IN BODILY INJURY, DEATH, OR PROPERTY DAMAGE.**

For your own safety, this section provides instructions for avoiding potential dangers when using this product.

#### QUALIFIED PERSONNEL

This product should be operated by qualified personnel only. Qualified personnel are individuals who are familiar with the operation of the product and the hazards involved with such operation.

#### DAMAGED OR MISSING HARDWARE

Do not operate the product if there is physical damage or hardware is missing.

#### MAXIMUM RATINGS

The maximum ratings in this data sheet should never be exceeded. Stress above one or more maximum ratings may cause permanent damage to the product and may permanently and irreversibly affect the quality and reliability of the product, which may increase the risk of bodily injury, death, or property damage.

#### HAZARDOUS RF VOLTAGES

The RF voltages inside the product and on the center pin of the RF output connector can be hazardous. Contact with the internal components of the product or the center pin of the RF output connector may lead to burns or electrical shock. Disconnect power before removing the protective cover from the product. Note that removing the protective cover from the product will void the express warranty specified in Mini-Circuits Standard Terms.

To reduce the risks presented by these hazards:

1. never operate the product without its protective cover,
2. always connect the RF output connector to a load before the power source is applied to the product, and
3. always place the product in a non-operating condition before disconnecting or connecting the load to the RF output connector.

#### COOLING

RF Power amplifiers always need proper cooling. Failure to properly cool the product may increase the risk of bodily injury, death, or damage to property or the product.

Some products contain water cooling systems to help cool down the product. If this data sheet indicates that the product contains a water cooling system, proper waterflow as specified in this data sheet is required to keep the temperature of the product within the temperature range that is specified in this data sheet.

Some products also contain built-in protection circuitry designed to shut-off the amplifier at excessive high temperatures or at other excessive operating conditions. Even if this data sheet indicates that the product contains protective circuitry, such protective circuitry is not a substitute for proper handling in accordance with these instructions. Accordingly, do not rely on the protective circuitry to prevent injury or damage to property or the product.

#### MAINTENANCE CAUTION

Maintenance or repair of the product must only be performed by qualified personnel when the product is in a non-operating condition and disconnected from its power source. Note that performance of maintenance or repairs to the product will void the express warranty specified in Mini-Circuits Standard Terms.

#### ENVIRONMENTAL CONDITIONS

Unless otherwise stated in this data sheet, this product is designed to be operated under the environmental conditions set forth in this data sheet, as well as the following conditions:

- Indoor use only
- Temperature of 5°C to 40°C (non-condensing)

#### WARNING SIGNS

In addition to being qualified before operating the product, pay attention to all warning signs and danger symbols. Failure to heed warnings signs and danger symbols, or to follow their associated instructions, may result in bodily injury, death, or property damage.

#### NOTES

- A. Performance and quality attributes and conditions not expressly stated in this specification document are intended to be excluded and do not form a part of this specification document.
- B. Electrical specifications and performance data contained in this specification document are based on Mini-Circuit's applicable established test performance criteria and measurement instructions.
- C. The parts covered by this specification document are subject to Mini-Circuits standard limited warranty and terms and conditions (collectively, "Standard Terms"); Purchasers of this part are entitled to the rights and benefits contained therein. For a full statement of the standard terms and the exclusive rights and remedies thereunder, please visit Mini-Circuits' website at [www.minicircuits.com/terms/viewterm.html](http://www.minicircuits.com/terms/viewterm.html)

