



## COAXIAL SOLID-STATE

# High Power Signal Source

## RFS-2G42G5050+ RFS-2G42G5050X+

50 Ω 50 W 2.4 to 2.5 GHz MCX to SMA-Female

### THE BIG DEAL

- High output power, 50 W
- 2.4 to 2.5 GHz ISM band
- Suitable for CW and pulsed signals
- High gain, 53 dB typical
- High efficiency, 42%
- High ruggedness
- Built-in monitoring and protection for temperature, current, forward and reflected power
- Includes signal generation and control
- User friendly USB or 3.3V RS232 UART interface
- Labview™ instrument drivers and Modbus interface available
- Can operate as a stand-alone amplifier



Generic photo used for illustration purposes only

Model No.	RFS-2G42G5050+	RFS-2G42G5050X+
Case Style	VU3689	VU3401
Connectors	MCX & SMA-F	

### APPLICATIONS

The RFS-2G42G5050X+ module can be used as a building block in any single or multi-channel system for high power RF Energy applications such as:

- Materials processing
- Food processing (heating, tempering, and pasteurization)
- Microwave-assisted chemistry
- Plasma generation
- Plasma surface treatment
- Disinfection/Sterilization
- Chemistry
- Medical (heating, hyperthermia, and ablation)
- Semiconductor RF generators

### PRODUCT OVERVIEW

The RFS-2G42G5050X+ is a new generation solid state connectorized high-power signal source module which can be used in a wide range of industrial, scientific, and medical applications in the 2400-2500 MHz ISM band. The RFS-2G42G5050X+ is a fully programmable, versatile, and flexible RF signal generator. The RFS-2G42G5050X+ provides many advantages over traditional magnetrons, such as longer lifespan, frequency tuning, better frequency stability, precise control of output power, and lower power supply voltage. This rugged high power signal source is capable of providing signals (CW & pulsed) from 0.5W to 50W output power with built-in monitoring and protection for temperature, current, supply voltage, forward power, and reverse power. The RFS-2G42G5050X+ includes a signal generator that can be adapted by the end user to support different types of applications. The RFS-2G42G5050X+ can also be used as a stand-alone high-power amplifier including control, monitoring, and protection features.

The high-power signal source (or amplifier when configured as such) has internal shutdown circuitry and integrated protection functions for added reliability under difficult operating conditions, making it virtually impossible to destroy. The basic high-power signal source can be controlled externally through a user-friendly USB interface to monitor forward and reflected power to support dynamic load analysis, temperature monitoring, current monitoring, shutdown alarms, enable/disable the signal source/amplifier, and for resetting protection alarms.

Full software support is provided, including a user-friendly GUI application, a comprehensive application programming interface (API) and programming instructions for both Windows and Linux environments, and a Labview™ instrument driver.

**KEY FEATURES**

Features	Advantages
High CW Power	Supports high power applications for a wide range of industrial, scientific, and medical applications in the 2400 – 2500 MHz ISM frequency band. Power can be regulated accurately from 0.50W up to 50W @+25C.
High Gain	When operated as a standalone amplifier, the typical gain is 51.5dB. Any commercially available 2400 – 2500 MHz signal generator capable of delivering -4dBm or more is sufficient to drive the RFS-2G42G5050X+ to full rated power.
High Efficiency	The RFS-2G42G5050X+ uses high efficiency state of the art LDMOS technology. This combined with adaptive frequency control enables maximum efficiency in the application.
Built-in protection	The RFS-2G42G5050X+ has built-in monitoring and protection for temperature, voltage, current, forward power, reverse power, and internal shutdown circuitry for added reliability under difficult operating conditions. When the prestored limits shown in the protection limits table are exceeded, the signal source/amplifier will shut down.
Built-in signal generation	Versatile and flexible small signal RF generator specifically designed to control RF Energy applications in the 2400 - 2500 MHz band.
Ruggedness	The RFS-2G42G5050X+ has excellent reverse isolation and ruggedness with an onboard circulator. Reverse power is monitored, and the signal source/amplifier is shut down when the reverse power exceeds the prestored limits shown in the protection limits table.
Forward & Reverse Power detection	The RFS-2G42G5050X+ features integrated couplers and detectors for Forward (FWD) and Reflected (REFL) power detection. FWD and REFL power detection supports reproducible RF power measurements as well as dynamic load analysis and can be used to control or shut-off the signal source/amplifier by using the internal monitoring or an external controller.
Easy interfacing	Easy access to the RFS-2G42G5050X+ through USB or UART interface, enabling dynamic ISM applications with either single or multiple modules to be controlled. Analog outputs for Forward- and Reflected power measurements provide real time feedback. Digital inputs and outputs permit low-level interfacing to the unit for minimum control overhead implementations.
Small and lightweight	With a small footprint (65mm x 110mm x14.5mm) and lightweight (0.14 kg) the modular design is flexible for single or multiple system integration.
Cooling	The signal source/amplifier can either be air or water cooled by mounting to a heatsink using the mounting holes available on the module.
Low voltage	The RFS-2G42G5050X+ is powered by a low voltage 28V supply.
Firmware	Integrated powerful microcontroller, capable of accommodating the board control firmware Calibrated Forward and Reflected RF power, voltage, current, and temperature measurements. Autogain control loop provides accurate power delivery over a wide range of settings and environmental conditions. Embedded memory to store calibration data, use-case profiles, modulation patterns etc. Dedicated USB functions to communicate with connected modules. Powerful embedded functions provide: - fast S11 power sweep across the frequency band (2.4 to 2.5GHz). - reflected power minimum lock + tracker. - pulse width modulation (PWM) for fine-tuned process control Safe operating area (SOA): Configurable, fast protection algorithms to react to thermal and RF overstress
GUI	Module supported by a dedicated GUI. Supports user designed application-level software A comprehensive manual to program and control the RF generator is provided.



## HIGH POWER SIGNAL SOURCE ELECTRICAL SPECIFICATIONS AT +25°C, 28V, 50Ω SYSTEM, 3.3V LOGIC LEVELS

Parameter	Symbol	Conditions	Min.	Typ.	Max.	Units
Frequency Range	f		2400	—	2500	MHz
Frequency Step Resolution	f <sub>RES</sub>	f=2400 MHz to 2500 MHz	100	—	—	KHz
Frequency Accuracy	F <sub>ACC</sub>	f=2400 MHz to 2500 MHz	—	±1	—	MHz
Output Power Setting	P <sub>OUT</sub>	f=2400 MHz to 2500 MHz	0.5	—	50	Watts
			27	—	47	dBm
Output Power Control Range	P <sub>OUT_CTRL</sub>	f=2400 MHz to 2500 MHz	20	—	—	dB
Output Power Control Resolution	P <sub>OUT_RES</sub>	f=2400 MHz to 2500 MHz	—	0.25	—	dB
Output Power Meas. Resolution	P <sub>OUT_MEAS_RES</sub>	f=2400 MHz to 2500 MHz, @47dBm P <sub>OUT</sub>	—	0.1	—	dB
PWM Duty Cycle <sup>1</sup>	PWM-DC	f=2400 MHz to 2500 MHz	5	—	99	%
PWM Frequency <sup>1</sup>	PWM-Freq	f=2400 MHz to 2500 MHz	1	—	19.8	kHz
Efficiency	η	f=2400 MHz to 2500 MHz, @47dBm P <sub>OUT</sub>	36	42	—	%
Operating Voltage	V <sub>DC</sub>	f=2400 MHz to 2500 MHz	—	28	—	V
Supply Current	I <sub>DC</sub>	f=2400 MHz to 2500 MHz, @47dBm P <sub>OUT</sub>	—	4.25	5	A
Temperature Sense <sup>4,5</sup> (Based on analog output)	T <sub>SENSE</sub>	T <sub>SENSE</sub> = (-72.183 x TEMP_AOUT) + 187.04 (TEMP_AOUT is the analog voltage on pin 10 of the 30 Pin conn., Ctrl1. Temperature can also be read thru USB)				°C
Supply Current Measured (Based on analog output)	I <sub>CURRENT</sub>	I <sub>CURRENT</sub> = (2.05 x ISENSE_AOUT) + 0.04 (ISENSE_AOUT is the analog voltage on pin 8 of the 30-pin connector, Ctrl1 Current can also be read thru USB)				A
Signal Source On / Off	—	Signal Source On / Off Enable (TTL low, default) / Disable (TTL high) on Pin 7 of the 30-pin connector, Ctrl1.				

## STAND-ALONE HIGH POWER AMPLIFIER ELECTRICAL SPECIFICATIONS AT +25°C, 28V, 50Ω SYSTEM, 3.3V LOGIC LEVELS

Parameter	Symbol	Conditions	Min.	Typ.	Max.	Units
Frequency Range	f		2400	—	2500	MHz
Input Power	P <sub>IN</sub>	f=2400 MHz to 2500 MHz @0dB Atten. setting and 47 dBm P <sub>OUT</sub>	—	-4	0	dBm
Output Power	P <sub>OUT</sub>	f=2400 MHz to 2500 MHz @0dB Atten setting	50	—	See Notes 2 & 3	MHz
			47	—	See Notes 2 & 3	dBm
Power Gain	G <sub>P</sub>	f=2400 MHz to 2500 MHz @0dB Atten. setting and 47 dBm P <sub>OUT</sub>	49	51.5	—	dB
Power Gain Flatness	G <sub>FLAT</sub>	f=2400 MHz to 2500 MHz @0dB Atten. setting and 47 dBm P <sub>OUT</sub>	—	1	2.0	dB
Efficiency	η	f=2400 MHz to 2500 MHz @0dB Atten. setting and 47 dBm P <sub>OUT</sub>	36	42	—	%
Input VSWR	I <sub>VSWR</sub>	f=2400 MHz to 2500 MHz @0dB Atten. setting and 47 dBm P <sub>OUT</sub>	—	1.5	2.0	
Operating Voltage	V <sub>DC</sub>	f=2400 MHz to 2500 MHz	—	28	—	V
Supply Current	I <sub>DC</sub>	f=2400 MHz to 2500 MHz @0dB Atten. setting and 47 dBm P <sub>OUT</sub>	—	4.25	5.0	A



# COAXIAL SOLID-STATE

# High Power Signal Source

# RFS-2G42G5050+ RFS-2G42G5050X+

50 Ω 50 W 2.4 to 2.5 GHz MCX to SMA-Female

### SAFE OPERATING AREAS AND PROTECTION LIMITS<sup>2</sup>

Parameter	Warning Limits		Shutdown Limits		Units
	Low	High	Low	High	
Temperature Sense <sup>4</sup>	—	55	—	65	°C
Forward Power	—	55	—	65	Watts
	—	47.4	—	48.15	dBm
Reverse Power	—	53	—	60	Watts
	—	47.25	—	47.8	dBm
Voltage Supply	26	32	24	34	V
Current Supply	—	5.5	—	6.0	A

### ABSOLUTE MAXIMUM RATINGS<sup>3</sup>

Parameter	Ratings
Operating Temperature <sup>4</sup>	0°C to +65°C
Storage Temperature	-20°C to +85°C
Operating DC Voltage	+32 V
Input RF Power	0 dBm
Forward Output Power	65 W
Power into the RF output connector	60 W
Current Supply	6.0 A
Fan Supply Current (only on model with heatsink)	3 A

- To ensure accurate power readings (and therefore accurate power output), the minimum value of the duty cycle changes along with the PWM frequency. See the PWM section for more detail.
- There are two reactions to excessive operation depending on severity. If the parameter reaches a level that is high but still tolerable a warning error will be raised. If the parameter is dangerously high and exceeds the prestored limits the module will be shut down and remain disabled until a reset command is sent thru the USB interface or by applying a logic high level to pin 5 of the multi-pin connector, Ctrl1.
- RFS-2G42G5050X+ may operate up to these maximum ratings with no damage, permanent damage may occur if any of these limits are exceeded.
- This is the sensed operating temperature calculated from the analog output, TEMP\_AOUT, or read thru USB from the RFS-2G42G5050X+. There is an offset from the temperature measured at the temp. sense location to the module pallet base of approximately +5 to 10°C. I.e. When the internal sensed temperature read from the module is +65°C then the temperature at the base of the pallet is approximately +70 to +75°C.
- When operating in auto-gain mode, a high reflection warning also indicates that the forward power is being throttled to prevent a high reflection shutdown condition. This behavior is detailed in the Safe Operating Area (SOA) application note, AN-50-011.

### BLOCK DIAGRAM

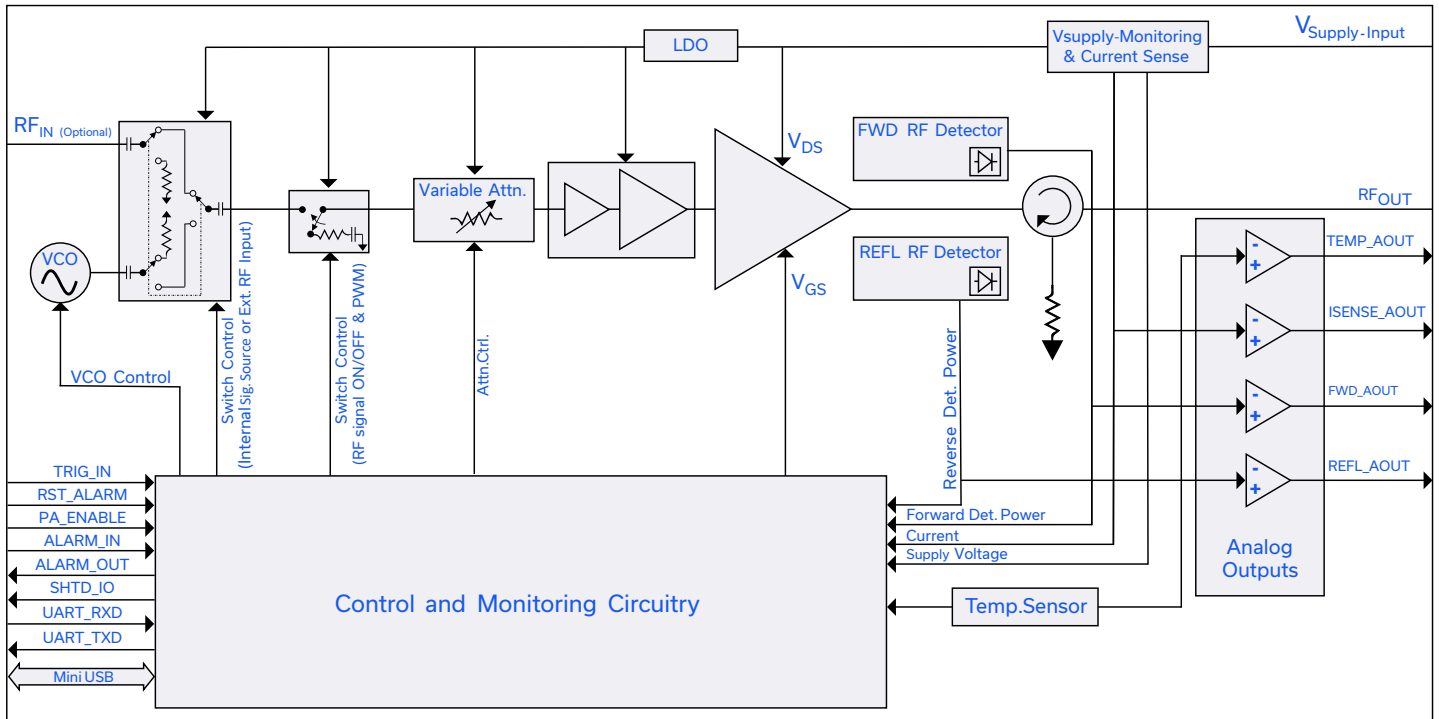



### TYPICAL PERFORMANCE DATA FOR AMPLIFIER MODE (28V, 50Ω SYSTEM)

Power Gain & Efficiency as a function of Output Power (dBm)  
@+25°C

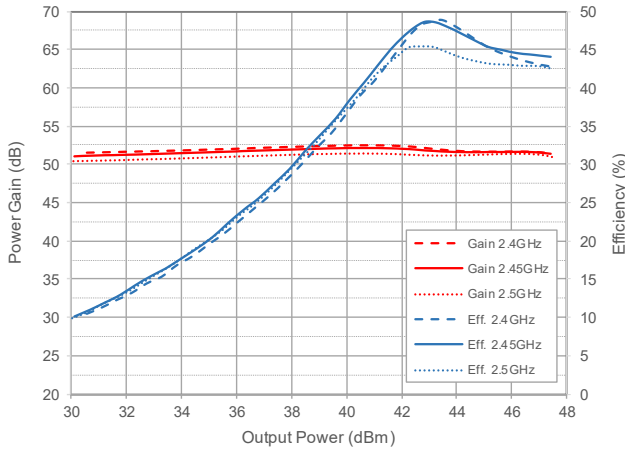

Power Gain & Efficiency as a function of Output Power (dBm)  
@ 2.45GHz for +25°C & +65°C

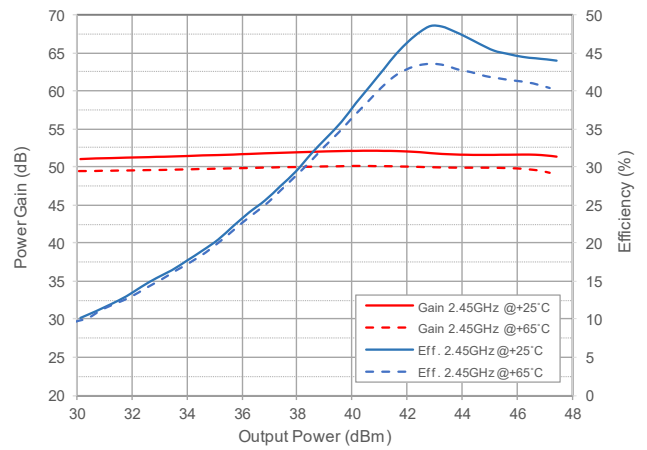

Power Gain & Efficiency as a function of Output Power (W)  
@ +25°C

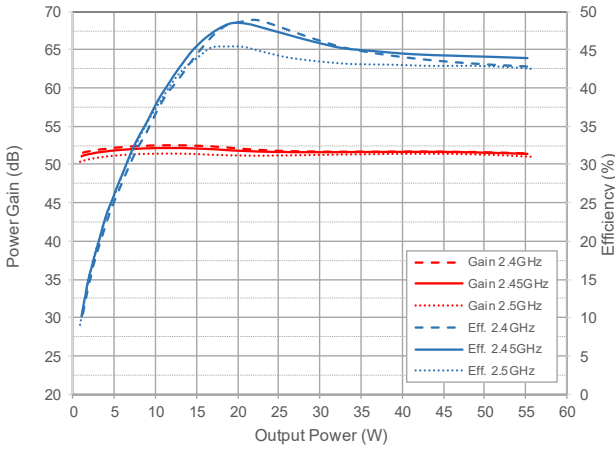

Power Gain & Efficiency as a function of Output Power (W)  
@ 2.45GHz for +25°C & +65°C

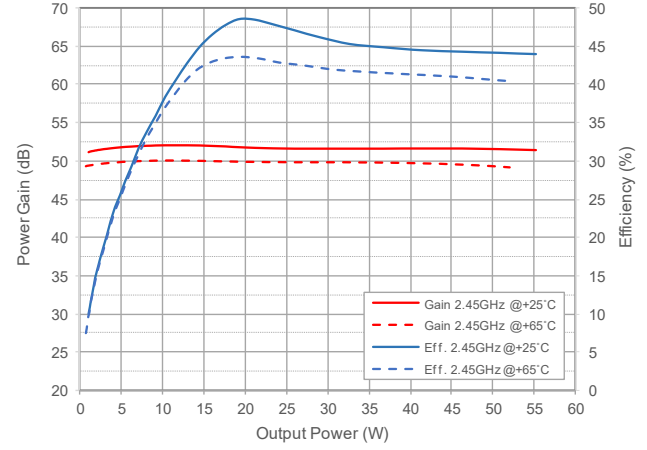

Power Gain & Compression as a function of Frequency  
@ 50W Output Power, +25°C

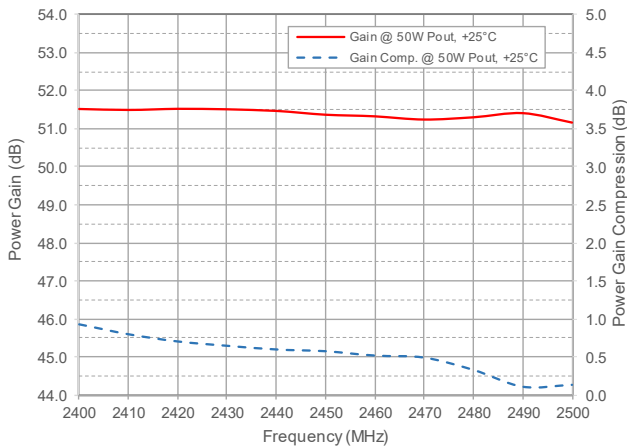

Power Gain & Compression as a function of Frequency  
@ 50W Output Power, +65°C

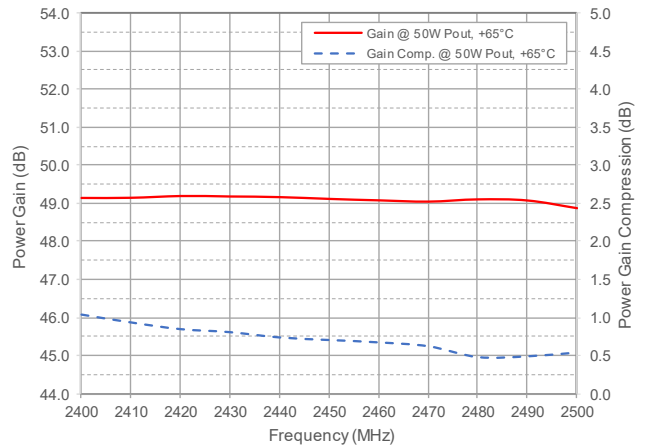



COAXIAL SOLID-STATE

# High Power Signal Source

## RFS-2G42G5050+ RFS-2G42G5050X+

50 Ω 50 W 2.4 to 2.5 GHz MCX to SMA-Female

### TYPICAL PERFORMANCE DATA FOR AMPLIFIER MODE (28V, 50Ω SYSTEM)

Efficiency as a function of Frequency  
@ 50W Output Power, +25°C

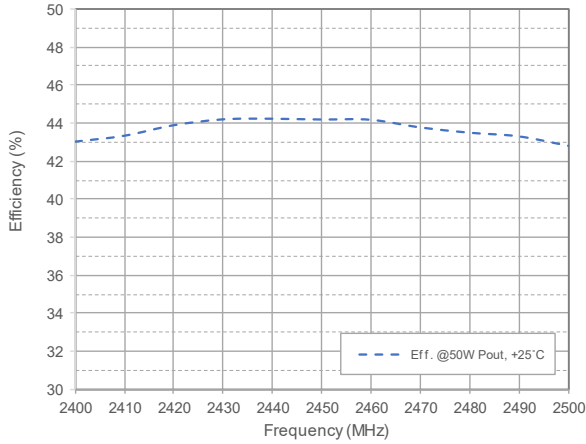

Efficiency as a function Frequency  
@50W Output Power, +65°C

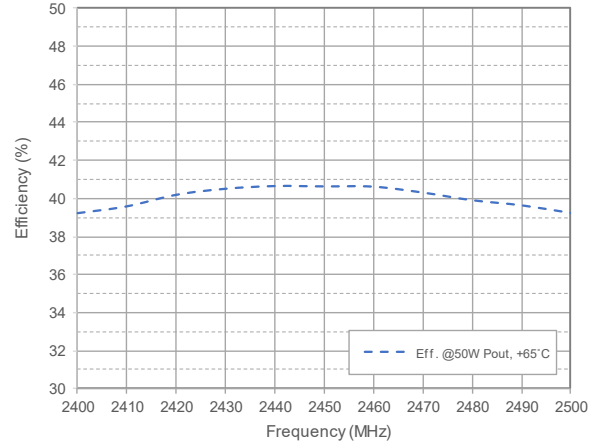

FWD\_AOUT (forward power analog output voltage)  
as a function of Output Power @ +25°C

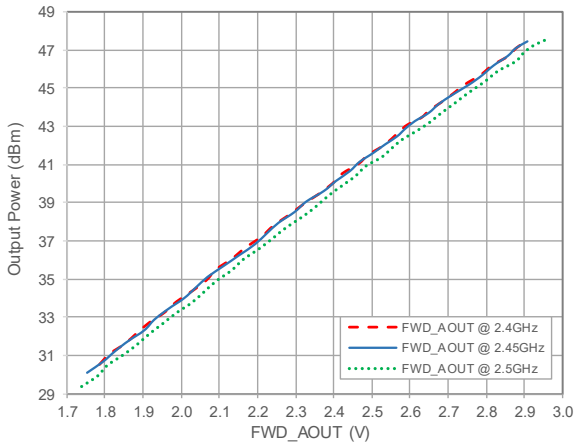

REFL\_AOUT (reflected power analog output voltage)  
as a function of Power into the RFout connector @ +25°C

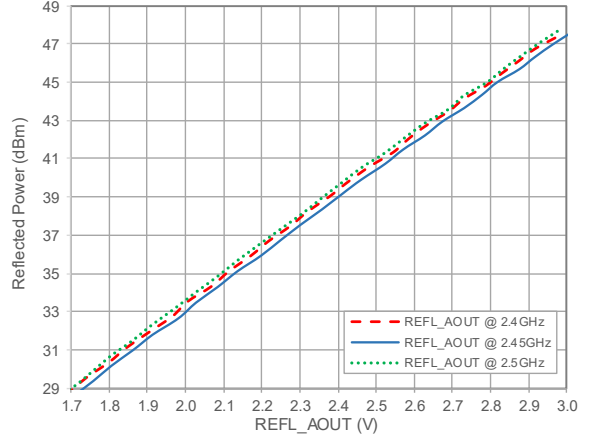



### HEATSINK REQUIREMENTS

Depending on the end system design or architecture either water cooling or air cooling must be used to cool the RFS-2G42G5050X+ module. In order to provide the user with the flexibility to decide on the cooling type, Mini-Circuits provides the RFS-2G42G5050X+ without a heat sink and the user decides what type of cooling they want to use. It is critical that the amplifier is always mounted to a heatsink where the airflow of a fan on an air-cooled heat sink or the water temperature and flow rate of a water-cooled heatsink is set to keep the amplifier below 65degC at full RF power when operating, otherwise the amplifier will get too warm and the built-in protection alarms will be activated and the power amplifier will shut itself down. The Application note, AN-50-128 describes how to mount the RFS-2G42G5050X+ to a Mini-Circuits air cooled heatsink (HSK-2G42G5050+). This is a heat sink that is designed specifically for the RFS-2G42G5050X+ module and is also available through the Mini-Circuits website. The heat sink version of the amplifier (RFS-2G42G5050+) is an assembly that includes the heatsink, fan, and fan speed controller. The fan speed controller modulates the fan speed based on the temperature of the heat sink to reduce noise and power consumption when operating in a standby or lower power mode.

### APPLICATION OVERVIEW

The RFS-2G42G5050X+ can operate as a standalone RF power generator when connected to a DC power supply and mounted to a heat sink. The high-power signal source is ready to deliver RF power to any applicator, i.e., a "device" to contain and/or apply the RF energy. The use of the latest generation solid state devices guarantees high efficiency, long lifetime, fully controllable and stable output power in a compact module outline. The module has built-in monitoring and protection for temperature, current, supply voltage, forward power, reverse power, and internal shutdown circuitry for added reliability under difficult operating conditions, making it virtually impossible to destroy in single and multi-channel systems due to the integrated circulator and protection functions. When the prestored limits shown in the protection limits table are exceeded the module will shut down and remain disabled until an alarm reset is sent either by command via USB or a TTL high applied to pin 5 of the multi-pin connector, Ctrl1. For advanced mode, users may consult the factory for more in-depth control commands and protection overrides. The RFS-2G42G5050X+ can operate in both CW and PWM mode. When operating in PWM mode a minimum of two 1000uF or one 2400uF electrolytic capacitors should be used and located on the DC power supply line close to the amplifier supply terminals in parallel from the +28V supply to ground. These capacitors will increase reliability of the amplifier in PWM mode and improve the RF waveform overshoot and ripple in the pulse.

### OPERATION MODE

There are two operation modes supported by the RFS-2G42G5050X+ when configured as either an RF signal source or a standalone amplifier.

#### 1. STANDARD OPERATION MODE (STDOM)

- Signal source/amplifier Enable/Disable
- Ability to set output power level and frequency. (Signal source only)
- Built-in protection features enabled
- Ability to reset protection shutdown via USB command or logic high on pin 5 of the multi-pin connector, Ctrl1.
- Access to analog outputs for temperature, forward power, reverse power, and current that can be correlated to output power.
- Access through USB to read Temperature (°C), forward power (dBm or W), reverse power (dBm or W), supply voltage (V), and current (A).

#### 2. ADVANCED OPERATION MODE (ADVOM)

- All the "standard operation mode" features are available.
- Access to enable/disable internal protection shutdown or change prestored internal shutdown limits (warranty is no longer valid in this situation).
- Access to all digital data for forward detected power, reverse detected power, temperature, supply voltage, and current.
- With either mode the external analog, digital signals, and control logic can optimize the RF vector (frequency, power, and time) depending on the application's needs in real time.





# COAXIAL SOLID-STATE

# High Power Signal Source

# RFS-2G42G5050+ RFS-2G42G5050X+

50 Ω 50 W 2.4 to 2.5 GHz MCX to SMA-Female

### CASE STYLE DRAWING (WITHOUT HEATSINK)

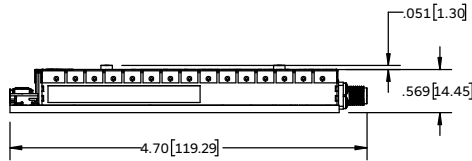
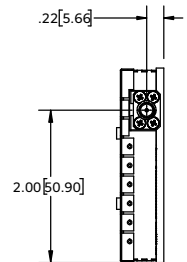
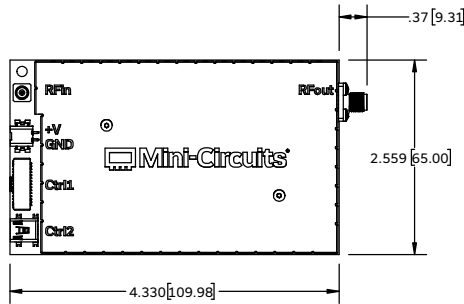
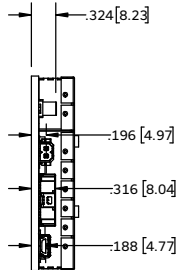
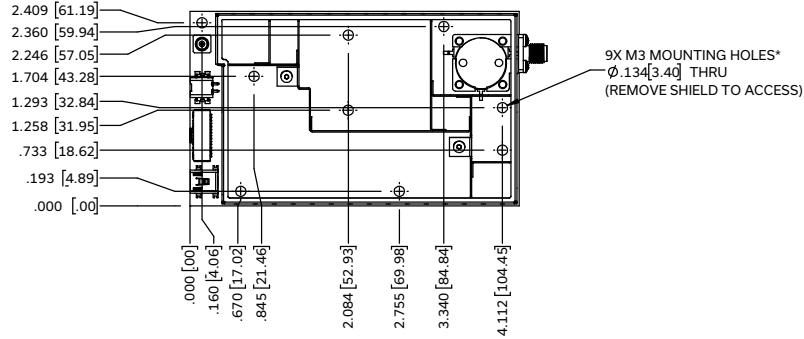

SHIELD COVER SCREWS  
2X M2X0.4X5MM  
USE 1.3MM HEX WRENCH

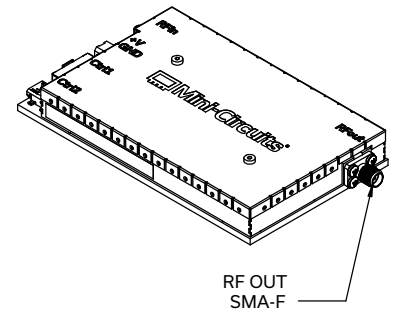
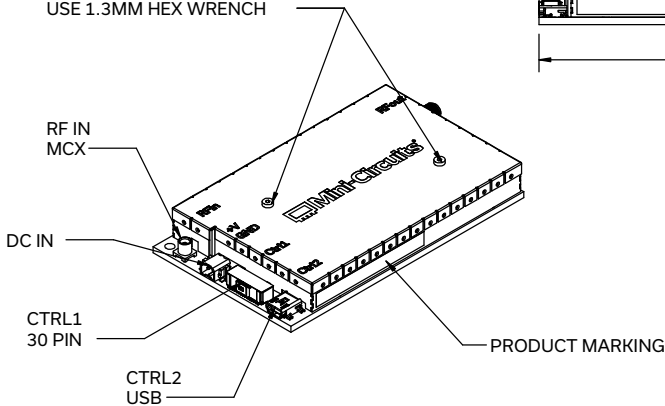

Weight: 140 grams

Dimensions are in inches [mm]. Tolerances: 2 Pl.±.01 [0.254]; 3 Pl.±.005 [0.127] Inches[mm]

### PRODUCT MARKING\*: RFS-2G42G5050X+

\*Marking may contain other features or characters for internal lot control







# COAXIAL SOLID-STATE

# High Power Signal Source

## RFS-2G42G5050+ RFS-2G42G5050X+

50 Ω 50 W 2.4 to 2.5 GHz MCX to SMA-Female

### CASE STYLE DRAWING (WITH HEATSINK)

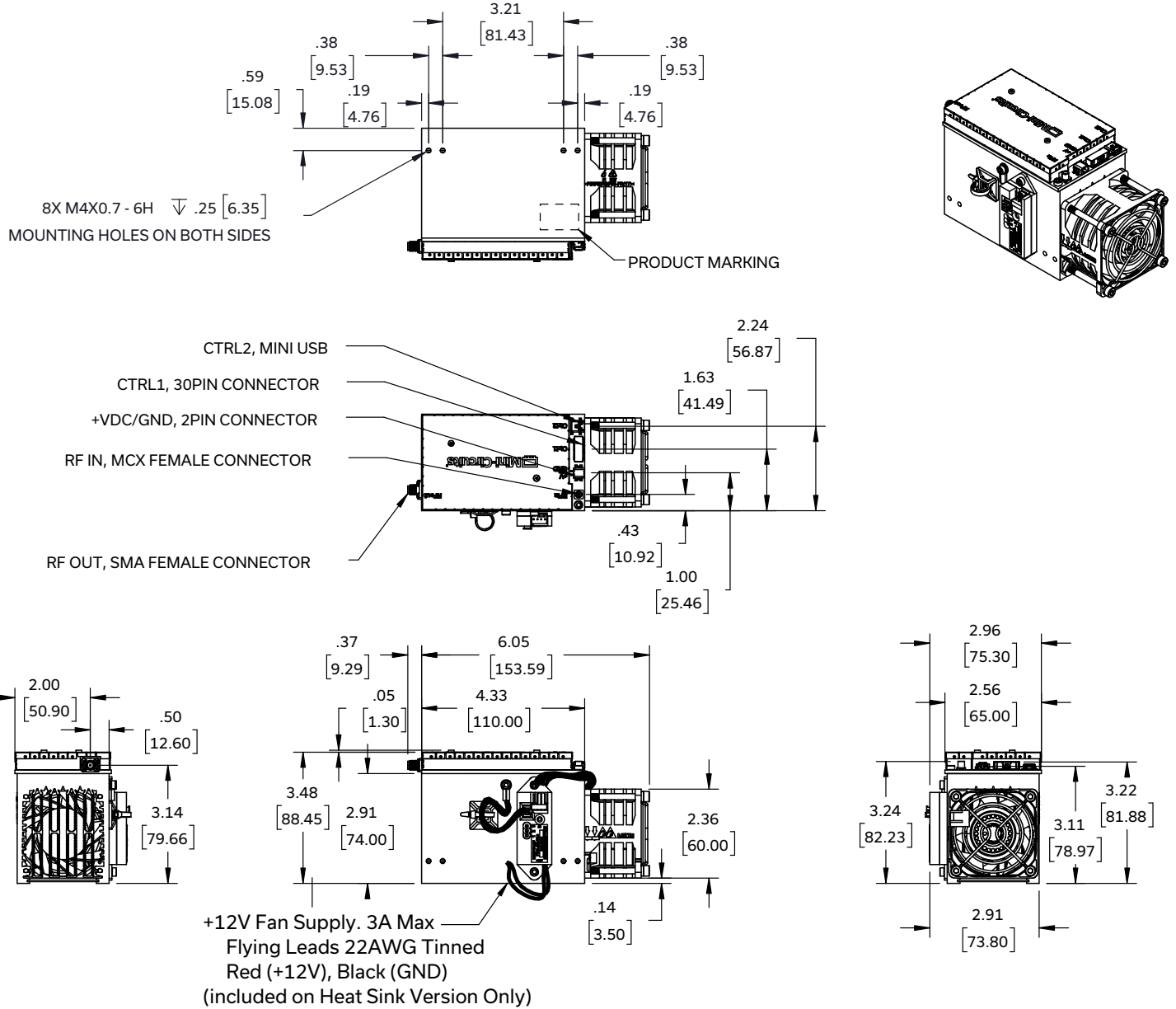

Weight: 952.50 grams

Dimensions are in inches [mm]. Tolerances: 1 pl.  $\pm 0.05$ inch, 2 pl.  $\pm 0.03$ inch, 3 pl.  $\pm 0.015$ inch

**PRODUCT MARKING\*:** RFS-2G42G5050+

\*Marking may contain other features or characters for internal lot control



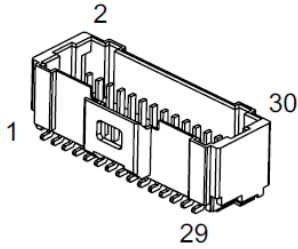

### CTRL1: CONTROL INTERFACE PIN OUT AND FUNCTIONALITY

Pin Number	Label	Functionality and Control
1	TRIG_IN	Used during externally supplied pulse mode operation. Automated gain control is disabled in this operating mode.
2	REFL_AOUT	Analog voltage (0 to 3.3V) that can be correlated to the level of the reflected power or power incident at the RFout connector.
4	FWD_AOUT	Analog voltage (0 to 3.3V) that can be correlated to the level of the forward output power.
5	RST_ALARM	Reset Alarm – Internal protection shutdown can be reset thru USB communication or applying a TTL high to this pin.
7	PA_ENABLE	Enable (TTL low) / Disable (TTL high). Normally low, enabled, and can be disabled when a TTL high is applied.
8	ISENSE_AOUT	Analog voltage (0 to 3.3V) that correlates to the signal source/amplifier current level
9	ALARM_IN	This input can be connected to a system controller to shut down the module or can be connected to other RFS-2G42G5050X+ modules in a system in a daisy chain configuration ALARM_OUT, pin13 of Ctrl1, to ALARM_IN, pin 9 of Ctrl1 to shut down all modules when there is a shutdown error present. This pin is normally low and can be set to a TTL high to shut-down the module.
10	TEMP_AOUT	Analog voltage (0 to 3.3V) that can be correlated to the temperature. See equation in electrical specification table.
11	Do Not Connect	Reserved pin for manufacturer.
13	ALARM_OUT	When the protection limits are exceeded and the module is shutdown, this pin will go from normally TTL low to TTL high. This output signal can be used by an external controller to adjust operating conditions or shut down the system. It can be connected to other RFS-2G42G5050X+ modules in a system in a daisy chain configuration ALARM_OUT, pin13 of Ctrl1, to ALARM_IN, pin 9 of Ctrl1 to shut down all modules when there is a shutdown error present.
14	SHTD_IO	This pin is similar to using the ALARM_IN and ALARM_OUT connected in a daisy-chain configuration with other modules except SHTD_IO is intended as a bidirectional bus-line. In a system with multiple RFS-2G42G5050X+ modules all SHTD_IO lines can be connected. This pin is normally high and any unit connected can signal and error state by pulling this pin low. Other modules would observe SHTD_IO being asserted, shutdown, and produce and alarm out.
16	Do Not Connect	Reserved pin for manufacturer.
17	Do Not Connect	Reserved pin for manufacturer.
20	Do Not Connect	Reserved pin for manufacturer.
21	Do Not Connect	Reserved pin for manufacturer.
24	UART_RXD	UART control
25	Do Not Connect	Reserved pin for manufacturer.
28	UART_TXD	UART control
29	Do Not Connect	Reserved pin for manufacturer.
3, 6, 12, 15, 18, 19, 22, 23, 26, 27, 30	GND	Ground

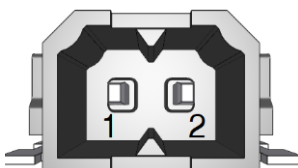

### DC POWER SUPPLY PIN OUT AND FUNCTIONALITY

Pin Number	Label	Functionality and Control
1	+V	+28V DC Supply Voltage Input (Pin closest to the MCX RF input)
2	GND	Ground



COAXIAL SOLID-STATE

# High Power Signal Source

**RFS-2G42G5050+**  
**RFS-2G42G5050X+**

50 Ω 50 W 2.4 to 2.5 GHz MCX to SMA-Female

## RFS-2G42G5050X+ INTERFACES AND SUGGESTED MATING HARDWARE\*

	<p>RFIN - MCX Connector Jack, Female Socket 50 Ohm (Molex P/N 73415-1692)  Mating Cable: 12" SMA Male to MCX Right Angle Cable Mini-Circuits P/Ns: FL086-12SMMCR+, 086-12SMMCR+</p>
	<p>+V and GND – DC Supply Connector, 2-pin pluggable terminal block.  (Phoenix Contact P/N 1778764)  Mating connector: Phoenix Contact P/N 1778832, 2 position terminal block plug.</p>
	<p>Ctrl1 - Control Connector, 30 Pin (Molex 203564-3017)  Mating connector shell:  Molex 501189-3010, and wires with pre-crimped leads, Molex 79758-1018 or 79758-1019.</p>
	<p>Ctrl2 - Control Connector, Mini USB Type AB, USB 2.0, Receptacle, 5 Position  (Samtec P/N MUSB-05-S-AB-SM-A)</p> <p>Mating Cable:  USB Type A to type Mini B Plug 2.69FT. Mini-Circuits P/N: MUSB-CBL-3+  USB Type A to type Mini B Plug 6.86FT. Mini-Circuits P/N: MUSB-CBL-7+</p>
	<p>Output connector SMA female  Recommended Torque for stainless steel SMA connector mate is 0.56 N-m (5 in-lbs) for lab testing and 0.90 N-m (8 in-lbs) for final installation.</p>
	<p>+12V Fan Supply. 3A Max  Flying Leads 22 AWG Tinned  Red (+12V), Black (GND)  (Included on Heat Sink Version Only)</p>

\*Mating hardware not included with the RFS-2G42G5050X+. Similar mating hardware available from other manufacturers.



## COAXIAL SOLID-STATE

# High Power Signal Source

## RFS-2G42G5050+ RFS-2G42G5050X+

50 Ω 50 W 2.4 to 2.5 GHz MCX to SMA-Female

### SOFTWARE & DOCUMENTATION DOWNLOAD

Full software support is provided, including a user-friendly GUI application, a comprehensive application programmer interface (API) and programming instructions for both Windows and Linux environments, and a Labview™ instrument driver. The latest version of the GUI and programming examples can be downloaded from [www.minicircuits.com/softwaredownload/RF-Energy-software\\_download.html](http://www.minicircuits.com/softwaredownload/RF-Energy-software_download.html) at any time. Further support documentation is available from the model dashboard page. (url: <https://www.minicircuits.com/WebStore/dashboard.html?model=RFS-2G42G5050X%2B>)

### MINIMUM SYSTEM REQUIREMENTS

Parameter	Requirements	
System Requirements	GUI Windows	Windows 7 or newer
	GUI Linux	Raspberry Pi 3 hardware; USB, Ethernet (for GUI's remote command mode); operating system: Raspbian Stretch or newer.
		Operation system ≥ Debian 9 or similar

### GRAPHICAL USER INTERFACE (GUI) KEY FEATURES

- Control of signal source operation
- Set frequency and output power
- Configure generator state at start-up
- Perform S11 sweep and display frequency response.
- Track optimum S11 frequency in real time (DLL routine)
- CW & Pulse width modulation signals
- Forward and reflected power tracking real time

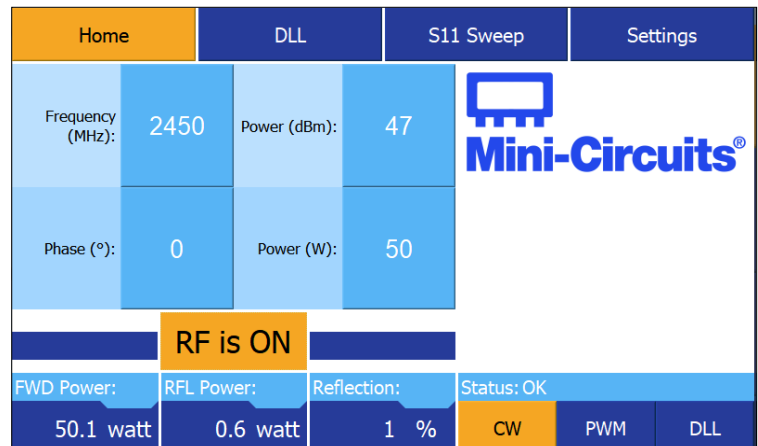

### APPLICATION PROGRAMMING INTERFACE (API) SUPPORT

Application programmer's interface (API) implemented through plain-text command language.

### CONTROL AND BASIC COMMANDS

The RFS-2G42G5050X+ supports USB-based communication. Once the module is connected to a Windows™ or Linux™ computer, the generator will appear as virtual com-port and be usable as UART (universal asynchronous receive and transmit interface). Baud rate is 115200, no parity, 1 stop bit. Further support documentation can be found in the application notes AN-50-009 Quick Start Guide, AN-50-010 Programming Manual, AN-50-011 Safe Operation Area, AN-50-005 Digital Locked Loop, AN-50-005 Guidelines on how to interface with Programmable Logic Controllers, AN-50-012 GUI User Manual, and AN-50-013 Quick Start Companion.





### SIGNAL SOURCE

When the RFS-2G42G5050X+ is powered ON, the default configuration will be as a signal source with the input select switch set to the internal VCO, VCO off, Freq. -2450MHz, the internal attenuator set to 31.75dB, and PA Enable OFF. Using basic commands or connecting and opening the Graphical user Interface (GUI) application the frequency and output power can be set, an S11 sweep can be performed to find the frequency with the minimum reflected power from the applicator, and the DLL function can be used to locate and track the minimum reflected power point. Along with a sample of basic commands listed below the complete guide to optimizing the signal source is described in the supporting documentation application notes.

### \$FCS – SET SIGNAL SOURCE FREQUENCY

This command sets the frequency of the signal source in MHz.

Syntax:

<b>Input</b>	\$FCS,[channel],[frequency]
<b>Output</b>	\$FCS,[channel],OK

- [channel] – Channel identification number.
- [frequency] – The desired frequency setting for the RF signal.

Example:

<b>Input</b>	\$FCS,1,2450
<b>Output</b>	\$FCS,1,OK

This sets the frequency to 2450 MHz

### \$PWRS – SET SIGNAL SOURCE OUTPUT POWER SETPOINT IN WATT

This command sets the signal source output to the desired level in Watt

Syntax:

<b>Input</b>	\$PWRS,[channel],[power watt]
<b>Output</b>	\$PWRS,[channel],OK

- [channel] – Channel identification number.
- [Power Watt] – The desired power level for the RF signal in Watt.

Example:

<b>Input</b>	\$PWRS,1,50
<b>Output</b>	\$PWRS,1,OK

This sets the output power setpoint to 50W.

### \$ECS – ENABLE/DISABLE

This command enables and disables the amplifie signal source.

Syntax:

<b>Input</b>	\$ECS,[channel],[Enable/Disable]
<b>Output</b>	\$ECS,[channel],OK

- [channel] – Channel identification number.
- [Enable/Disable] – 1 for enable and 0 for disable.

Example:

<b>Input</b>	\$ECS,1,1
<b>Output</b>	\$ECS,1,OK

This enables the signal source on.



### STAND-ALONE POWER AMPLIFIER

The module can be configured as a stand-alone power amplifier using the \$RFSS command shown below which sets the input select switch to the external RF input, the internal VCO will be set to OFF, the internal digital attenuator will be set to 0dB. When switching to amplifier mode, the PA is also switched to feed-forward mode. When switching back to signal source mode, the PA will be switched back to the default auto-gain control mode. Every use of the RFSS command will set the PA enable state to OFF. The internal attenuation level can be set using the \$GCS command and the PA can be enabled and disabled using the \$ECS command. Forward & Reflected Power<sup>1</sup>, Current, Voltage, and Temperature can be read from the RFS-2G42G5050X+ using the commands described in the application note AN-50-010 Programming Manual. Note, not all the commands will apply when using the module as a stand-alone amplifier.

1. The internal forward and reflected power detector readings are calibrated over frequency. To ensure the best possible accuracy on forward and reflected power readouts, it is important to set the frequency of the amplifier to the frequency of the signal supplied to amplifier input using the GUI or \$FCS command.

### \$RFSS – SET MODULE TO STAND-ALONE AMPLIFIER CONFIGURATION

This command will allow the module to switch from the default Signal Source configuration to the Stand-Alone Amplifier Configuration and back.

#### Syntax:

<b>Input</b>	\$RFSS,[channel],[source]
<b>Output</b>	\$RFSS,[channel],OK

- [channel] – Channel identification number.
- [source] – 0 for internal VCO and 1 for external RF input

#### Example:

<b>Input</b>	\$RFSS ,1,1
<b>Output</b>	\$RFSS ,1,OK

This sets the module to the Stand-Alone Amplifier configuration with external RF input.

#### Example:

<b>Input</b>	\$RFSS ,1,0
<b>Output</b>	\$RFSS ,1,OK

This sets the module back to the internal Signal Source configuration.



### PULSE WIDTH MODULATION (PWM) OPERATION

The RFS-2G42G5050X+ has the capability to produce a PWM signal when configured as a signal source. It also has the capability to read the forward power and reflected power during the pulse when configured as a signal source or when configured as a stand-alone PA using an external PWM input signal.

When configured as a signal source the module can generate a modulated signal with no external RF or trigger inputs. However, The internal RF signal source can also be modulated external trigger, TRIG\_IN, on pin 1 of Ctrl1, use the \$ETS command to enable this feature. When configured as a stand-alone amplifier with an external PWM RF input, TRIG\_IN, is required on pin 1 of Ctrl1 to trigger ADC acquisitions and accurately read the forward and reflect power during the pulse. This feature is enabled using the \$ETSS command. More details of these and additional PWM commands can be found in the application note AN-50-010 Programming Manual.

Pulse Width Modulation allows the user to modulate the RF signal, and in turn the average power output of the system, by turning the signal ON and OFF at a set rate.

The following two parameters are used to achieve this:

- PWM frequency – Dictates how often the signal switches between ON and OFF.
- PWM duty cycle – Dictates the time ratio between ON and OFF each period.

Depending on the duty cycle, the average power output of the system will decrease to a percentage of its set output. For example, 50% duty cycle at 50W results in an average RF power output of 25W. To ensure sufficient measurement time of the RF signal, the pulses generated by any PWM scheme must not be too short. Hence, the permissible PWM frequency and duty cycle are dependent on each other. The PWM frequency can vary between 1000 Hz – 19800Hz. To ensure accurate power readings (and therefore accurate power output), the minimum value of the duty cycle changes along with the PWM frequency according to the following formula:

$$DC_{min} = ROUNDUP (f_{PWM} * T_{min \text{ pulse width}}/10,000)$$

Where:

- DCmin is the minimum duty cycle as a percentage.
- fPWM is the PWM frequency between 1000 and 19800 Hz.
- Tmin pulse width is the minimum pulse length in microseconds. The minimum pulse width to ensure sufficient measurement time of the RF signal is 50µs.

This means that at 1000 Hz, the minimum duty cycle is 5% and at 19800 Hz it is 99%. Going over this maximum frequency value would effectively disable PWM, as the minimum duty cycle becomes greater than 100%. The user needs to keep these limitations in mind – the system will not check for the limits. For a reasonable control range, PWM frequencies between 1 and 2 kHz are recommended.

### BASIC COMMANDS FOR PWM OPERATION IN SIGNAL SOURCE MODE

#### \$DCS - SET PWM DUTY CYCLE

This command sets the PWM duty cycle between 0% and 100%.

Note: This command doubles as a PWM ON/OFF switch. Setting the duty cycle to 100% is the same as turning PWM off entirely, thus there is no dedicated PWM ON/OFF command

Syntax:

<b>Input</b>	\$DCS,[channel],[duty cycle]
<b>Output</b>	\$DCS,[channel],OK

- [channel] – Channel identification number.
- [duty cycle] – A value between 0 and 100 that sets the duty cycle in percent. (default = 100%)

Example:

<b>Input</b>	\$DCS,1,50
<b>Output</b>	\$DCS,1,OK

This sets the PWM duty cycle to 50%.

Please note that the usable PWM frequency range in connection with the duty cycle parameter is limited to allow a minimum pulse width needed for proper functioning of the autogain functionality as described above.





### \$DCFS - SET PWM FREQUENCY

This command sets the frequency of the PWM signal.

#### Syntax:

<b>Input</b>	\$DCFS,[channel],[frequency],[reserved]
<b>Output</b>	\$DCFS,[channel],OK

- [channel] – Channel identification number.
- [frequency] – PWM frequency in Hz.
- [reserved] – Reserved. This parameter should only be written 0.

#### Example:

<b>Input</b>	\$DCFS,1,1200,0
<b>Output</b>	\$DCFS,1,OK

This sets the PWM frequency to 1200 Hz.

### \$DCG - GET ALL PWM SETTINGS

This command returns all the settings related to PWM

#### Syntax:

<b>Input</b>	\$DCG,[channel]
<b>Output</b>	\$DCG,[channel],[frequency],[correction factor],[trigger mode],[reserved],[reserved],[reserved],[reserved],[delay],[duty cycle]

- [correction factor] – The current correction factor for the PWM signal.
- [trigger mode] – The current operational mode of the PWM triggering.
  - 1 – Free running
  - 2 – Reserved. Parameter should be ignored.
  - 3 – Reserved. Parameter should be ignored.
- [reserved] – Reserved. Parameter should be ignored.
- [reserved] – Reserved. Parameter should be ignored.
- [reserved] – Reserved. Parameter should be ignored.
- [reserved] – Reserved. Parameter should be ignored.
- [delay] – The current percentage-based delay of the PWM signal.
- [duty cycle] – The current duty cycle percentage value.
- [channel] – Channel identification number.
- [frequency] – The current PWM frequency in Hz.

#### Example:

<b>Input</b>	\$DCG,1
<b>Output</b>	\$DCG,1,1200,0,1,255,255,255,255,0.00000,50

This indicates that the operational mode is configured to 'free running,' the PWM signal is configured to a frequency of 1200Hz with a duty cycle of 50% and there is no correction factor and no delay



COAXIAL SOLID-STATE

# High Power Signal Source

**RFS-2G42G5050+**  
**RFS-2G42G5050X+**

Mini-Circuits

50  $\Omega$  50 W 2.4 to 2.5 GHz MCX to SMA-Female

**ADDITIONAL INFORMATION IS AVAILABLE ON OUR DASHBOARD.**

Performance Data & Graphs	Data Graphs
RoHS Status	Compliant
Environmental Ratings	ENV23T32
Export Information	ECCN# EAR99

**ORDERING INFORMATION**

Model No. Links	<a href="#">RFS-2G42G5050+</a>	<a href="#">RFS-2G42G5050X+</a>
Product Marking	RFS-2G42G5050+	RFS-2G42G5050X+
Case Style	VU3689	VU3401
Connector	MCX to SMA-Female	MCX to SMA-Female





## SAFETY INSTRUCTIONS.

**WARNING: FAILURE TO FOLLOW THESE INSTRUCTIONS MAY RESULT IN BODILY INJURY, DEATH, OR PROPERTY DAMAGE.**

For your own safety, this section provides instructions for avoiding potential dangers when using this product.

### QUALIFIED PERSONNEL

This product should be operated by qualified personnel only. Qualified personnel are individuals who are familiar with the operation of the product and the hazards involved with such operation.

### DAMAGED OR MISSING HARDWARE

Do not operate the product if there is physical damage or hardware is missing.

### MAXIMUM RATINGS

The maximum ratings in this data sheet should never be exceeded. Stress above one or more maximum ratings may cause permanent damage to the product and may permanently and irreversibly affect the quality and reliability of the product, which may increase the risk of bodily injury, death, or property damage.

### HAZARDOUS RF VOLTAGES

The RF voltages inside the product and on the center pin of the RF output connector can be hazardous. Contact with the internal components of the product or the center pin of the RF output connector may lead to burns or electrical shock. Disconnect power before removing the protective cover from the product. Note that removing the protective cover from the product will void the express warranty specified in Mini-Circuits Standard Terms.

To reduce the risks presented by these hazards:

1. never operate the product without its protective cover,
2. always connect the RF output connector to a load before the power source is applied to the product, and
3. always place the product in a non-operating condition before disconnecting or connecting the load to the RF output connector.

### COOLING

RF Power amplifiers always need proper cooling. Failure to properly cool the product may increase the risk of bodily injury, death, or damage to property or the product.

Some products contain water cooling systems to help cool down the product. If this data sheet indicates that the product contains a water cooling system, proper waterflow as specified in this data sheet is required to keep the temperature of the product within the temperature range that is specified in this data sheet.

Some products also contain built-in protection circuitry designed to shut-off the amplifier at excessive high temperatures or at other excessive operating conditions. Even if this data sheet indicates that the product contains protective circuitry, such protective circuitry is not a substitute for proper handling in accordance with these instructions. Accordingly, do not rely on the protective circuitry to prevent injury or damage to property or the product.

### MAINTENANCE CAUTION

Maintenance or repair of the product must only be performed by qualified personnel when the product is in a non-operating condition and disconnected from its power source. Note that performance of maintenance or repairs to the product will void the express warranty specified in Mini-Circuits Standard Terms.

### ENVIRONMENTAL CONDITIONS

Unless otherwise stated in this data sheet, this product is designed to be operated under the environmental conditions set forth in this data sheet, as well as the following conditions:

- Indoor use only
- Temperature of 5°C to 40°C (non-condensing)

### WARNING SIGNS

In addition to being qualified before operating the product, pay attention to all warning signs and danger symbols. Failure to heed warnings signs and danger symbols, or to follow their associated instructions, may result in bodily injury, death, or property damage.

### NOTES

- A. Performance and quality attributes and conditions not expressly stated in this specification document are intended to be excluded and do not form a part of this specification document.
- B. Electrical specifications and performance data contained in this specification document are based on Mini-Circuit's applicable established test performance criteria and measurement instructions.
- C. The parts covered by this specification document are subject to Mini-Circuits standard limited warranty and terms and conditions (collectively, "Standard Terms"); Purchasers of this part are entitled to the rights and benefits contained therein. For a full statement of the standard terms and the exclusive rights and remedies thereunder, please visit Mini-Circuits' website at [www.minicircuits.com/terms/viewterm.html](http://www.minicircuits.com/terms/viewterm.html)