



Mechanical Switch Assembly RCM-2SP8T-40

50Ω DC to 40 GHz 2 x SP8T 2.92 mm female

THE BIG DEAL

- 2 x mechanical SP8T absorptive switches
- High port count with excellent performance to 40 GHz
- Compact benchtop package with power supply
- Ethernet & USB control
- LED switch state indicators



Generic photo used for illustration purposes only

APPLICATIONS

- Benchtop and rack-mounted automated test systems
- 5G FR1 & FR2, WiFi 6E, millimeter wave radio infrastructure
- Military radio, radar & electronic warfare
- Switch matrices

FUNCTIONAL BLOCK DIAGRAM

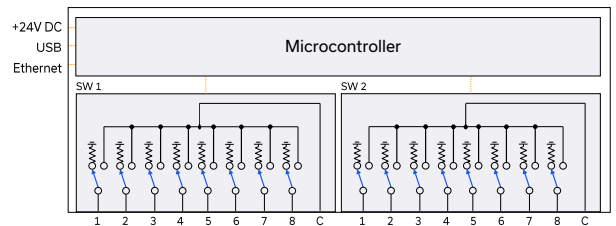

PRODUCT OVERVIEW

Mini-Circuits' RCM-2SP8T-40 houses 2 independently controlled electro-mechanical SP8T switches. Each switch operates over an exceptionally wide bandwidth from DC to 40 GHz with high isolation and low insertion loss. The absorptive switches are fail-safe / normally open, with a break before make configuration, and lifetime of 2 million switching cycles when used within the noted specifications.

The switches are housed in a compact benchtop package with all 2.92 mm (female) RF connectors on the front along with LED indicators for a quick read out of switch states. Control and power connections are located on the rear panel.

The switch assembly can be controlled via USB or Ethernet (supporting HTTP and Telnet network protocols). Full software support is provided, including our user-friendly GUI application for Windows and a full API with programming instructions for Windows and Linux environments.

KEY FEATURES

Feature	Advantages
Mechanical switches	Mechanical absorptive switches provide low loss, high isolation, high reliability, repeatable performance and internal termination of input signals on the disconnected paths
Fail-safe design	The switches revert to a known default state when the DC supply is removed, allowing their use in systems that must continue to operate safely in the event of power failure
Ethernet & USB control	USB HID and Ethernet (HTTP & Telnet) interfaces ensure compatibility with most software environments and connection requirements.
Integrated control & power	Easy to use on the lab bench or integrate into larger automated test systems without the need to develop custom control systems.

REV. OR
ECO-023589
RCM-2SP8T-40
MCL NY
241213



Mechanical Switch Assembly **RCM-2SP8T-40**

ELECTRICAL SPECIFICATIONS AT +25°C (EACH SWITCH)

Parameter	Conditions (GHz)	Min.	Typ.	Max.	Units
Frequency		DC		40	GHz
Insertion Loss	DC - 12 GHz		0.20	0.40	dB
	12 - 26 GHz		0.30	0.70	
	26 - 40 GHz		0.70	1.50	
Isolation	DC - 12 GHz	75	100		dB
	12 - 26 GHz	70	80		
	26 - 40 GHz	55	70		
Return Loss ¹	DC - 12 GHz		22		dB
	12 - 26 GHz		16		
	26 - 40 GHz		12		
Switching Time			25		ms
RF Input Power (Cold Switching)	DC - 12 GHz			20	W
	12 - 26 GHz			5	
	26 - 40 GHz			1	
	Into internal terminations ³			1	
Switch Lifetime	100 mW hot switching ⁴	2			million cycles
	1W hot switching		1		

1. Isolation measured between Com and any disconnected port. Example: Isolation for Com to 1 is the leakage measured at port 1 from a signal input at Com when the active switch path is set to Com to 2
 2. Return loss into Com when active or ports 1-8 in any state; Com is reflective when disconnected
 3. Maximum power into any internal termination is 1W per port, 3W total per switch
 4. Hot switching power above this level will degrade the switch lifetime



Mechanical Switch Assembly RCM-2SP8T-40

TYPICAL PERFORMANCE CURVES

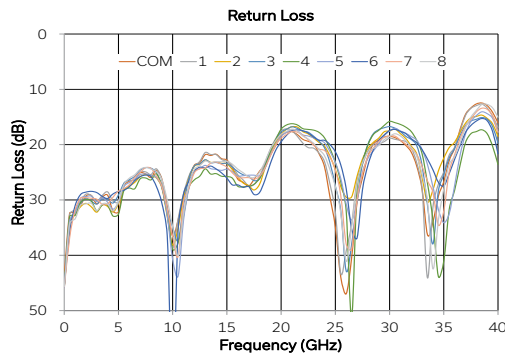
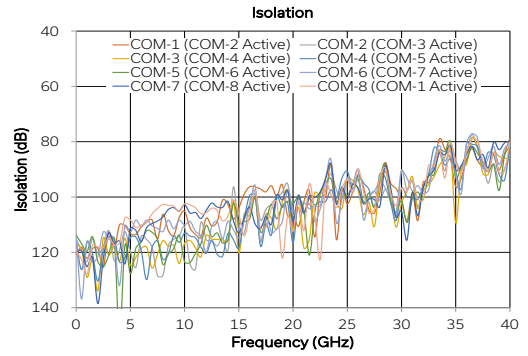
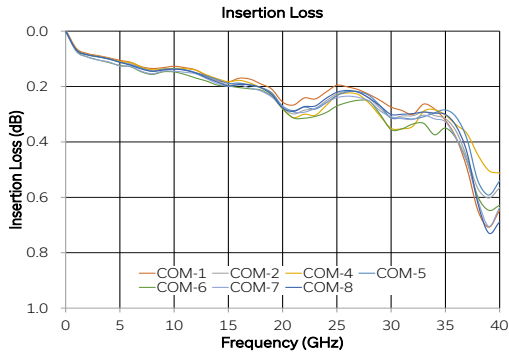



Mechanical Switch Assembly RCM-2SP8T-40

ABSOLUTE MAXIMUM RATINGS

Parameter	Conditions	Limits	Units
Temperature	Operating	0 to +50	°C
	Storage	-20 to +60	
DC Supply Voltage		26	V
Input Power (No Damage)	Cold switching:		W
	DC-12 GHz	20	
	12-26 GHz	5	
	26-40 GHz	1	
	Hot switching	1	
	Into internal termination	1	

Permanent damage may occur if any of these limits are exceeded. Operating in the range between operating power limits and absolute maximum ratings for extended periods of time may result in reduced life and reliability.

POWER SUPPLY

Parameter	Conditions	Typ	Max	Units
DC Voltage		24	26	V
Current Consumption	Both switches disconnected	100		mA
	Both switches connected	350		

CONNECTIONS

Parameter	Conditions
SW 1-2 (C & 1-8 per switch)	2.92 mm female
USB	USB type B
Ethernet / LAN	RJ45
24V DC Input	2.1 mm center positive DC socket

C = Common port
1-8 = Input / output ports

FUNCTIONAL BLOCK DIAGRAM

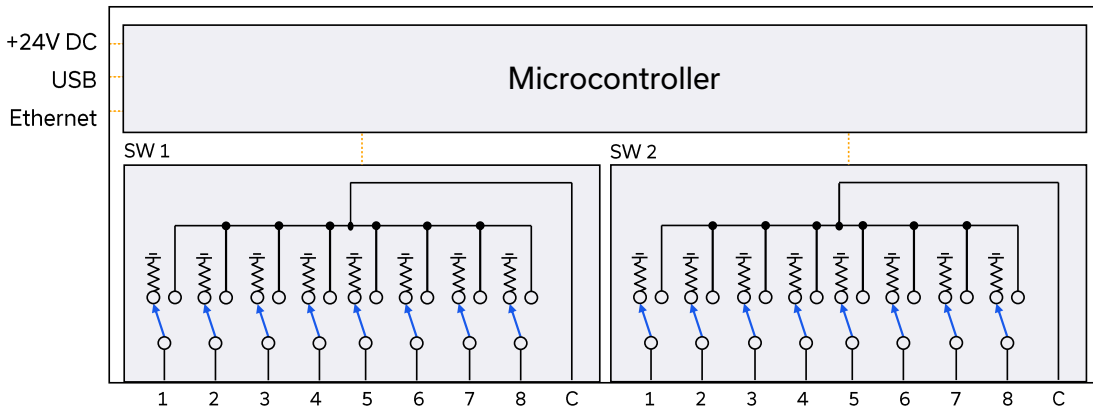

SWITCH STATE TABLE (EACH SWITCH)

Switch Command	Switch x State	Switch x LED State							
		LED1	LED2	LED3	LED4	LED5	LED6	LED7	LED8
:SP8T:[x]:STATE:0	All ports disconnected (C open; ports 1-8 terminated)	Off	Off	Off	Off	Off	Off	Off	Off
:SP8T:[x]:STATE:1	C to 1	On	Off	Off	Off	Off	Off	Off	Off
:SP8T:[x]:STATE:2	C to 2	Off	On	Off	Off	Off	Off	Off	Off
:SP8T:[x]:STATE:3	C to 3	Off	Off	On	Off	Off	Off	Off	Off
:SP8T:[x]:STATE:4	C to 4	Off	Off	Off	On	Off	Off	Off	Off
:SP8T:[x]:STATE:5	C to 5	Off	Off	Off	Off	On	Off	Off	Off
:SP8T:[x]:STATE:6	C to 6	Off	Off	Off	Off	Off	On	Off	Off
:SP8T:[x]:STATE:7	C to 7	Off	Off	Off	Off	Off	Off	On	Off
:SP8T:[x]:STATE:8	C to 8	Off	Off	Off	Off	Off	Off	Off	On



Mechanical Switch Assembly **RCM-2SP8T-40**

50Ω DC to 40 GHz 2 x SP8T 2.92 mm female

CONTROL INTERFACES

Ethernet Control	Supported Protocols	TCP / IP, HTTP, Telnet, DHCP, UDP (limited)
	Max Data Rate	10 Mbps (10 Base-T Half Duplex)
USB Control	Supported Protocols	HID - Full Speed
	Min Communication Time ¹	3 ms typ

5. Based on the polling interval of the USB HID protocol (1 ms with 64 bytes per packet) and no other significant CPU or USB activity

SOFTWARE & DOCUMENTATION

Mini-Circuits' full software and support package including user guide, Windows GUI, API, programming manual and examples can be downloaded free of charge (refer to the last page for the download path).

A comprehensive set of software control options is provided:

- GUI for Windows - Simple software interface for control via Ethernet and USB
- Programming / automation via Ethernet
 - Complete set of control commands which can be sent via any supported protocol - simple to implement in the majority of modern programming environments
- Programming / automation via USB
 - DLL files provide a full API for Windows with a set of intuitive functions which can be implemented in any programming environment supporting .Net Framework or ActiveX
 - Direct USB programming is possible in any other environment (not supporting .Net or ActiveX)

Please contact testsolutions@minicircuits.com for support

MINIMUM SYSTEM REQUIREMENTS

Hardware	Intel i3 (or equivalent) or later
GUI (USB or Ethernet Control)	Windows 7 or later
USB API DLL	Windows 7 or later with support for Microsoft .Net Framework or ActiveX
USB Direct Programming	Windows 7 or later; Linux
Ethernet	Windows, Linux or macOS with Ethernet TCP / IP support

PROGRAMMING COMMANDS

The key ASCII / SCPI commands for control of the system for control via the Ethernet or USB API are summarized below (refer to the programming manual for full details):

Command / Query	Description
:MN?	Read model name
:SN?	Read serial number
:FIRMWARE?	Read firmware version
:SP8T:[sw_label]:STATE:[port]	Set a single switch state: [sw_label] = 1 to 2 [port] = 0 (all ports disconnected) to 8 (Com to 8)
:SP8T:[sw_label]:STATE?	Get a single switch state: [sw_label] = 1 to 2



Mechanical Switch Assembly RCM-2SP8T-40

GRAPHICAL USER INTERFACE (GUI) FOR WINDOWS - KEY FEATURES

- Connect via USB or Ethernet
- Run GUI in "demo mode" to evaluate software without a hardware connection

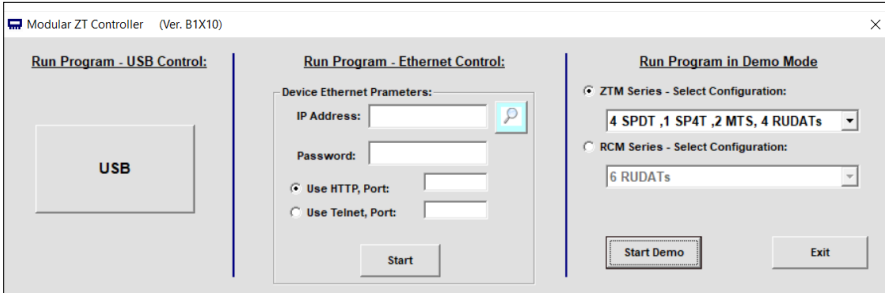

- View and set all switch states at the click of a button
- Configure automated / timed switching sequences
- Set switch power-up states
- Configure Ethernet settings
- Update firmware

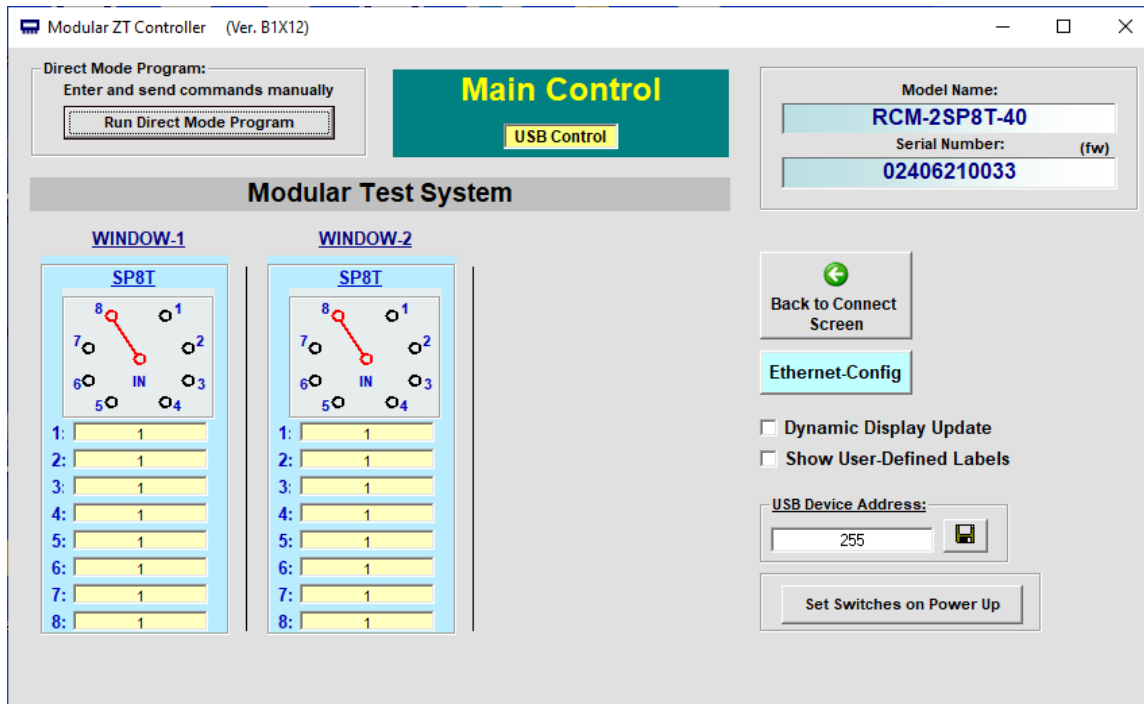



Mechanical Switch Assembly RCM-2SP8T-40

CASE STYLE DRAWING

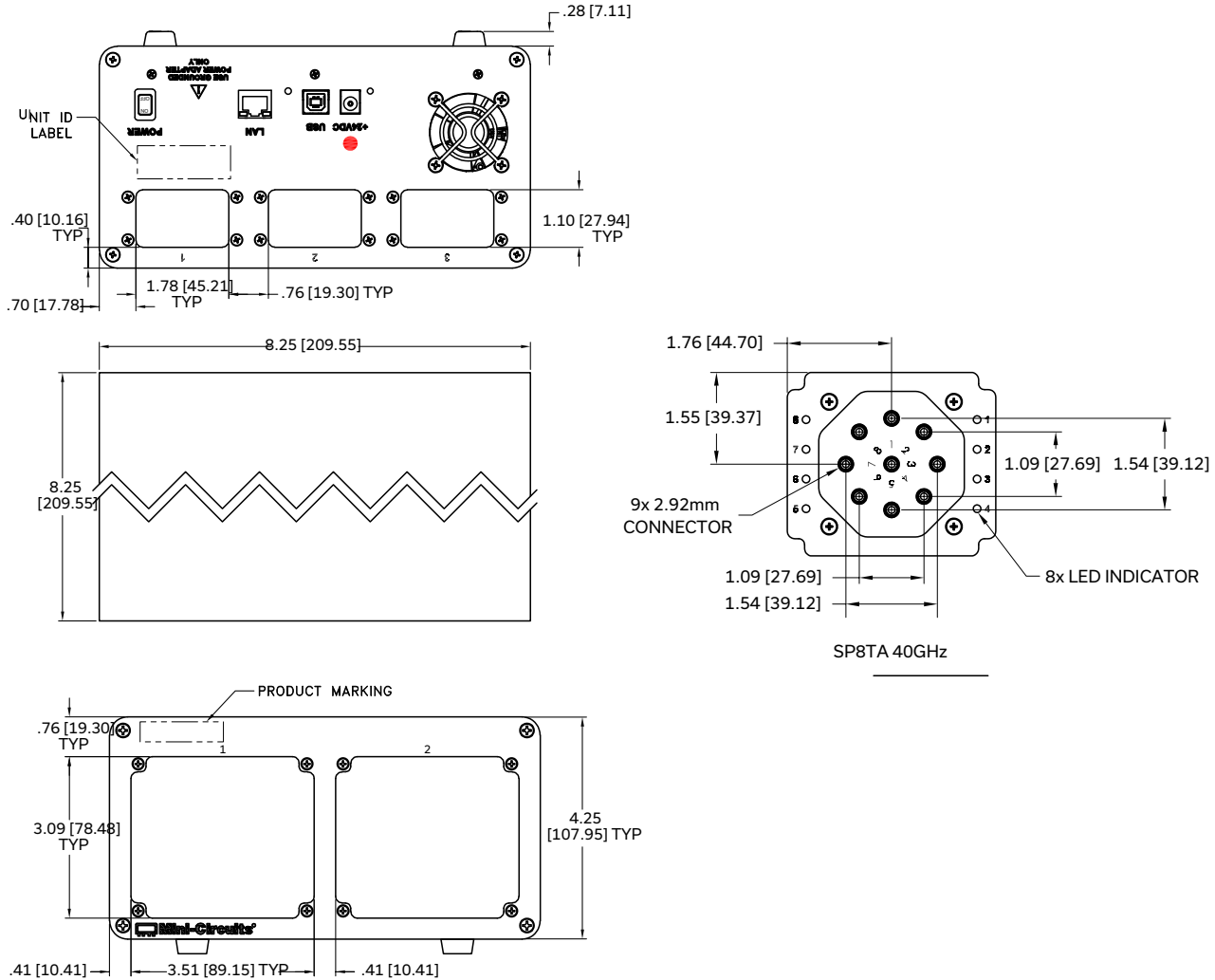

Weight: 2350 grams.

Dimensions are in inches [mm]. Tolerances: 2 Pl. ±.03 inch; 3 Pl. ±.015 inch

PRODUCT MARKING*

Product Marking: RCM-2SP8T-40

Serial Number

*Marking may contain other features or characters for internal lot control





Mechanical Switch Assembly **RCM-2SP8T-40**





50Ω DC to 40 GHz 2 x SP8T 2.92 mm female

DETAILED MODEL INFORMATION IS AVAILABLE ON OUR WEBSITE [CLICK HERE](#)

Case Style	UV2068	
Software, User Guide & Programming Manual	https://www.minicircuits.com/softwaredownload/ztm_rcm.html	
Environmental Rating	ENV55	
Regulatory Compliance	<p>Refer to our website for compliance methodologies and qualifications</p> 	www.minicircuits.com/quality/environmental_introduction.html

Contact Us: testsolutions@minicircuits.com

Included Accessories	Part Number	Description
	AC/DC-24-3W1	AC/DC 24V DC grounded power adaptor. Operating temperature 0 to +40 °C, max current 2.5A, IEC C6 AC inlet.
	CBL-3W1-xx	AC power cord (IEC C5 connector to local plug). Select one option from the list below. Please contact testsolutions@minicircuits.com if your regions is not listed.
	USB-CBL-AB-3+	USB cable (2.7ft) type A to type B
	CBL-RJ45-MM-5+	Ethernet cable (5 ft)

AC Power Cord Options	Part Number	Description
	CBL-3W1-US	USA NEMA 5-15 plug (type B) to IEC C5 connector
	CBL-3W1-EU	Europe CEE 7/7 plug (type E/F) to IEC C5 connector
	CBL-3W1-UK	UK BS-1363 plug (type G) to IEC C5 connector
	CBL-3W1-AU	Australia & China AS/NZS 3112 plug (type I) to IEC C5 connector
	CBL-3W1-IL	Israel SI-32 plug (type H) to IEC C5 connector

- NOTES**
- A. Performance and quality attributes and conditions not expressly stated in this specification document are intended to be excluded and do not form a part of this specification document.
 - B. Electrical specifications and performance data contained in this specification document are based on Mini-Circuit's applicable established test performance criteria and measurement instructions.
 - C. The parts covered by this specification document are subject to Mini-Circuits standard limited warranty and terms and conditions (collectively, "Standard Terms"); Purchasers of this part are entitled to the rights and benefits contained therein. For a full statement of the standard. Terms and the exclusive rights and remedies thereunder, please visit Mini-Circuits' website at www.minicircuits.com/MCLStore/terms.jsp