



THE BIG DEAL

- Trace modulation & pulse profiles with resolution down to 13 ns
- Measurement of modulated signals up to 30 MHz bandwidth
- Up to 80 dB power measurement range
- 80M samples per second
- Integrated display for quick power readings
- Complex trigger and trigger delay functions

APPLICATIONS

- 5G FR1, WiFi 6E, Bluetooth device testing
- Analysis of ASK, FSK, OFDM, QAM, LTE modulation
- C band pulsed radar testing
- Signal level calibration



Generic photo used for illustration purposes only.

PRODUCT OVERVIEW

Mini-Circuits' PWR-9PWHS-RC peak & average power sensor operates from 50 to 9000 MHz with an industry leading measurement range down to -40 dBm in peak mode and -60 dBm in average mode. The 80 Msps sample rate with internal buffer enables up to 120k complete measurements per second. With up to 30 MHz video bandwidth, complex analysis and profiling of pulsed and modulated inputs is possible down to 13 ns resolution.

The compact package includes a rubberized outer case for protection and portability, N-type RF input connector, integrated screen, SMB trigger input / output options and USB / Ethernet control.

The included measurement software for Windows walks the user through the power sensor settings, displays the current measurements and provides powerful data recording and export capabilities. A full API for Windows is also provided, with programming instructions and examples for Windows and Linux systems to set up automated power measurements in a range of common programming environments.

Mini-Circuits has a wide range of high-performance power sensors available on our [website](#). Consider the [PWR-9RMS-RC](#) RMS power sensor for applications involving wider modulation bandwidths (>30 MHz) or multi-tone signals.

KEY FEATURES

Feature	Advantages
Peak & average sensor with 80 Msps rate	Capture pulsed and modulated signals with exceptionally high data resolution and speed for peak, average and statistical analysis of inputs.
External trigger controls	Trigger in and out ports support precise synchronization with external test equipment, allowing capture of irregular signal patterns & pulses.
30 MHz selectable video bandwidth	30 MHz video bandwidth permits measurement and analysis of pulses with rise / fall times as low as 13 ns. Set the internal video filter with lower video bandwidths to reduce noise when this resolution is not required for the measurement at hand.
Video output port	Use in ALC (automatic level control) loops or observe the modulated signal directly on an oscilloscope for highest bandwidth.

Trademarks:

Windows is a registered trademark of Microsoft Corporation in the United States and other countries ; Linux is a registered trademark of Linus Torvalds ; Pentium is a registered trademark of Intel Corporation. Neither Mini-Circuits nor the Mini-Circuits products are affiliated with or endorsed by the owners of the referenced trademarks. Mini-Circuits and the Mini-Circuits logo are registered trademarks of Scientific Components Corporation.



ELECTRICAL SPECIFICATIONS, 25°C^{1,2}

Parameter	Conditions	Frequency (MHz)	Min.	Typ.	Max.	Unit
Frequency Range	-	-	50	-	9000	MHz
Input Power Range	Average Power Measurement	50 - 9000	-60	-	+20	dBm
	Peak Power Measurement		-40	-	+20	
Uncertainty of Power Measurement, +25°C ^{3,4}	-60 to -50 dBm (Avg mode)	50 - 9000	-	±0.2	±1.2	dB
	-50 to -30 dBm (Avg mode)		-	±0.2	±0.5	
	-40 to -30 dBm (Peak mode)		-	±0.2	±1.2	
	-30 to +20 dBm (Peak mode)		-	±0.2	±0.5	
Uncertainty of Power Measurement, 0°C to +50°C ^{3,4}	-60 to -50 dBm (Avg mode)	50 - 9000	-	±0.5	-	dB
	-50 to -30 dBm (Avg mode)		-	±0.3	-	
	-40 to -30 dBm (Peak mode)		-	±0.5	-	
	-30 to +20 dBm (Peak mode)		-	±0.3	-	
Return Loss	-	50 - 9000	18	21	-	dB
Linearity	-	50 - 9000	-	3	-	%
Measurement Resolution	-	50 - 9000	0.01	-	-	dB
Averaging Range	-	50 - 9000	1	-	999	-
Sample Period	Full Sampling Rate (Peak mode)	50 - 9000	0.001	-	0.025	ms
	Reduced Sampling Rate (Peak mode) ⁵	50 - 9000	-	-	1,000	
	Average mode	50 - 9000	0.320	-	125	
Measurement Rate ⁶ (including typical USB delays)	Sample Period= 1 μs	50 - 9000	-	500	-	per sec
Measurement Rate ⁶ (Buffered + Free Trigger mode)	Sample Period= 1 μs	50 - 9000	-	120,000	-	per sec
Sample Rate ⁷	Sample Period ≤ 25 μs	50 - 9000	-	80	-	MSPS
	Sample Period > 25 μs		-	2000/(sample period in μsec)	-	
Time Base Accuracy	-	-	-	-	50	ppm
Video Bandwidth ⁸	-	50 - 9000	-	-	30	MHz
Minimum Pulse Width	-	50 - 9000	-	-	70	ns
Rise/Fall Time ⁹	-	50 - 9000	-	13	-	ns
Pulse Duty Cycle for Pulse Profiling	-	50 - 9000	0.1	-	99.9	%
DC Current (I _{DC}) ¹⁰	Ethernet disabled	50 - 9000	-	475	550	mA
	Ethernet enabled		-	600	650	

- All specifications after 30 minutes warmup time and zeroing.
- Maximum continuous safe operational power limit: +23 dBm.
- Tested with CW signal and default sample period. For Sample period < (10 x Signal period), maintain Sample period = (N x Signal period). The sensor automatically switches from Peak to Average mode for signals below -30 to -40 dBm. Peak and average measurements are available above this threshold while only average measurements are possible below.
- Accuracy of readings at 50-100 MHz above +10 dBm may reach ±1.0 dB Typ.
- As sample period increases above 25 μs resolution will decrease. To get high resolution of the pulse while maintaining large sample period use the "zoom on pulse" function in pulse profiling (see [related page](#) for details).
- The number of complete measurements taken per second with the specified sample period. Buffered mode captures multiple sequential measurements within the sensor for later retrieval / analysis (see programming manual for details).
- The rate at which the sensor captures discrete samples over the specified sample period. With sample periods greater than 25 μs the sample rate will be reduced to allow covering the full sample period.
- Video bandwidth can be set to 1.5 MHz, 5 MHz or OFF (~30 MHz) for Peak mode, or switched to Average mode.
- The minimum rise/fall time (measured at 10% to 90% i.e. 0.5 to 10 dBc) or resolution that can be observed in a pulsed and modulated signal.
- It is recommended to use USB 3.0/3.1 port, a powered hub, or an external power supply (USB-AC/DC-5 or equivalent) in order to supply the current.



TRIGGER PARAMETERS, 25°C^{1, 2}

Parameter	Conditions	Min.	Typ.	Max.	Unit
Trigger Input Options ¹¹	Internal (on rise or fall), internal (on pulse width), external (on rise or fall), free running				
Trigger Timeout ¹²	Internal & External Triggers	1	-	5000	ms
Internal Trigger	Threshold (level)	-40	-	+15	dBm
	Resolution	-	1	-	dB
	Accuracy	-	0.5	-	dB
	Threshold (width)	Note 13	(sample period)/1000	-	(sample period)/2
Trigger In Delay (set by user)	Trigger to Start of Sample Period	-(sample period)/2	-	+42.9	s
Trigger Out Delay (from RF)	In Internal Trigger modes	-	250	-	ns
Trigger In	Logic Low	0	-	0.6	V
	Logic High	2.7	-	5.5	
Trigger Out ¹⁴ (into high impedance load)	Logic Low (Inactive)	0	-	0.3	
	Logic High (Active)	2.7	-	3.3	
Video Out @ 50 Ω load	Output Voltage	0.05	-	0.7	

11. Internal trigger modes are only available in peak mode. In Average mode Free running or external triggers should be used.

12. Trigger Timeout is set by default to 500 ms, but can be changed using SCPI commands. Please refer to programming guide for details

13. The internal trigger can be set to trigger on pulse widths either greater than or less than the specified value, in conjunction with the level threshold. When triggering on pulse width the measurement will start by default at the falling edge of the pulse.

14. Trigger Out behavior varies based on the trigger input mode:

In Free run & External modes trigger out will be active for the full duration of the sample period.

For internal trigger modes – The user can select between a “single” or “repeating” Trigger Out (refer to the programming manual for details on setting these modes).

The “single” option causes Trigger Out to be active for the duration of only the first pulse period detected within the sample period.

The “repeating” options causes Trigger Out to follow the RF pulse sequence, active for each pulse “on” time and inactive for each pulse “off” time within the sample period



TYPICAL PERFORMANCE GRAPHS

Uncertainty in Power Measurement @ Low Power Input

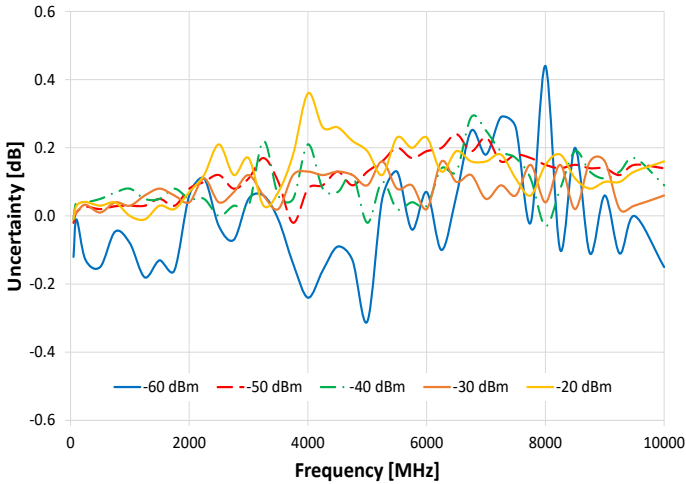

Uncertainty in Power Measurement @ High Power Input

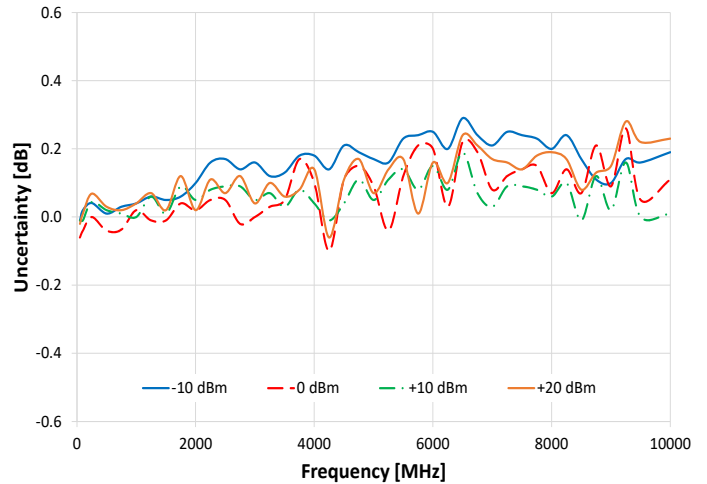

Linearity vs. Frequency

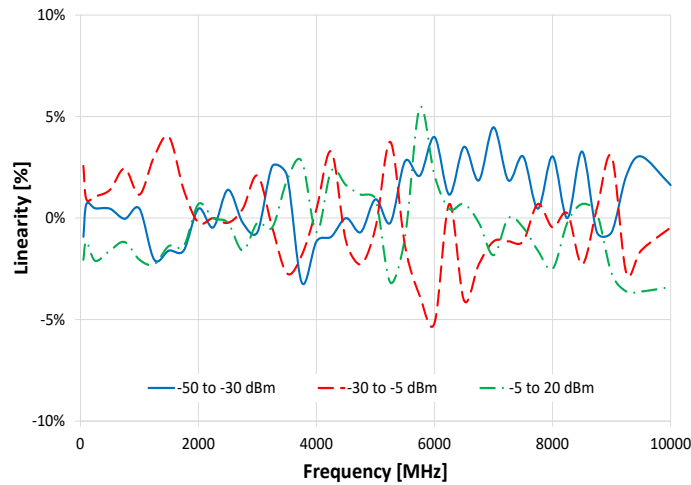

Return Loss vs. Frequency

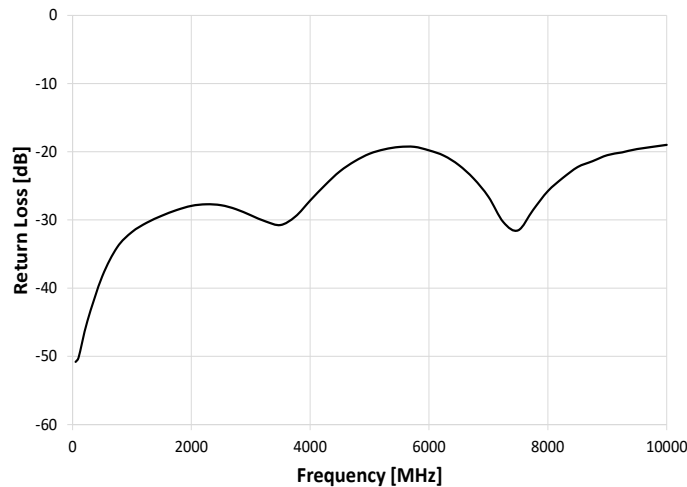



CONTROL INTERFACES

Ethernet Control	Supported Protocols	TCP / IP, HTTP, Telnet, DHCP, UDP (limited)
	Max Data Rate	100 Mbps (100 Base-T Full Duplex)
USB Control	Supported Protocols	HID (Human Interface Device) - High-speed
	Min Communication Time ¹⁵	400 μs typ (full transmit/receive cycle)

15. USB Min Communication Time is based on the polling interval of the USB HID protocol (125 μs polling interval, 64 bytes per packet), medium CPU load and no other high-speed USB devices using the USB bus.

SOFTWARE & DOCUMENTATION

Mini-Circuits' full software and support package including user guide, Windows GUI, API, programming manual and examples can be downloaded free of charge (refer to the last page for the download path).

A comprehensive set of software control options is provided:

- GUI for Windows – Simple software interface for control via Ethernet and USB.
- Programming / automation via Ethernet:
 - Complete set of control commands which can be sent via any supported protocol.
 - Simple to implement in the majority of modern programming environments.
- Programming / automation via USB:
 - DLL files provide a full API for Windows with a set of intuitive functions which can be implemented in any programming environment supporting .Net Framework or ActiveX.
 - Direct USB programming is possible in any other environment (not supporting .Net or ActiveX).

Please contact testsolutions@minicircuits.com for support.

MINIMUM SYSTEM REQUIREMENTS

GUI	Windows 7 or later
USB API DLL	Windows 7 or later and programming environment with ActiveX or .NET support
USB Direct Programming	Linux, Windows 7 or later
HTTP or Telnet	Any computer with a network port and Ethernet-TCP/IP (HTTP or Telnet protocols) support
Hardware	Intel i3 (or equivalent) or later
Control Cable	Power sensor to be used with the supplied USB cable only



GRAPHICAL USER INTERFACE (GUI) FOR WINDOWS - KEY FEATURES

- Connect via USB or Ethernet (HTTP, Telnet) to control the module.
- Control multiple power sensors at once.

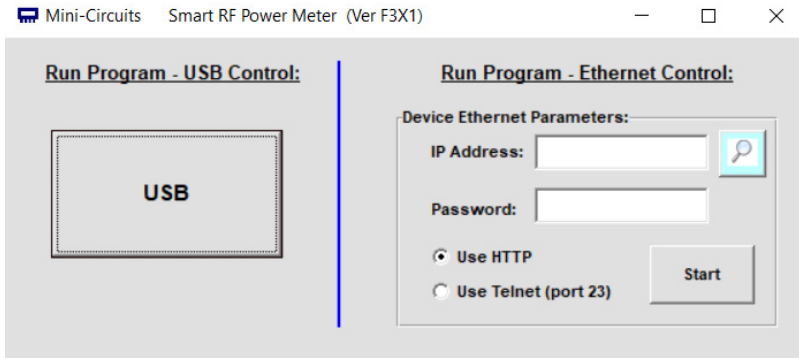

- Set compensation frequency and monitor power measurement.
- Configure measurement (offsets, relative power readings, averaging, set trigger mode, etc.).
- Zero the power sensor (recommended at the start of a new measurement session).
- Schedule data recording.

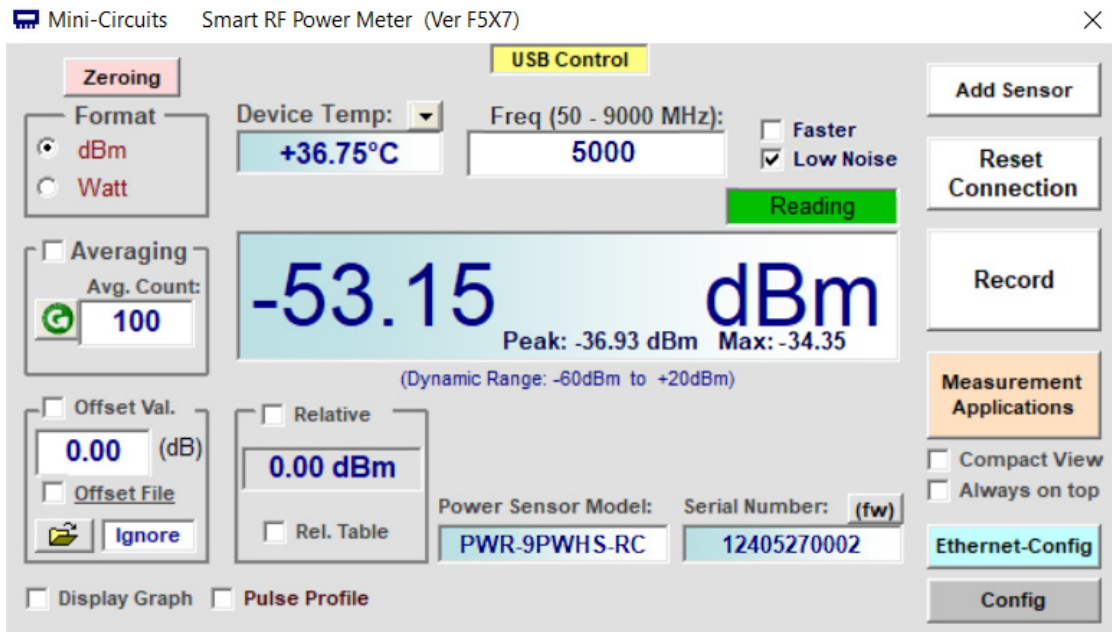



PULSE PROFILING FEATURES CONFIGURATION SCREEN

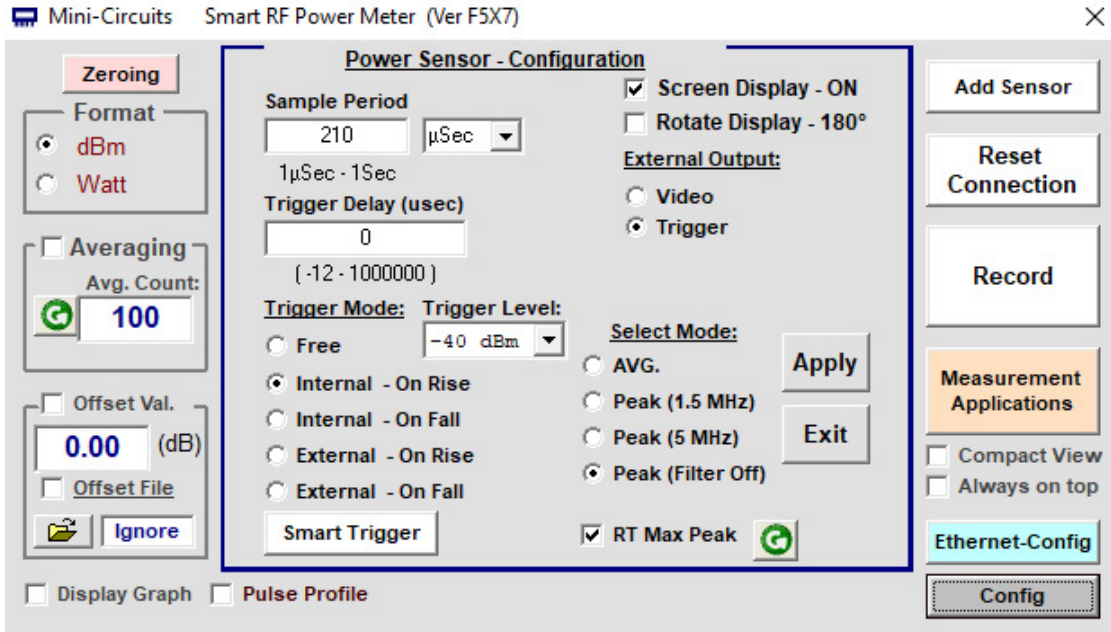

- Set the sample period (the time over which the sensor will average the power) between 1 μs and 1s.
- Select from 3 trigger type options (and the Smart Trigger option to further refine the desired trigger definition):
 1. Free – No trigger / free running measurements.
 2. Internal On Rise/Fall– Detect & stabilize the measurements on the rising/falling edge of RF signal (at the level specified).
 3. External On Rise/Fall – Measurements are triggered on the rising/falling edge of an external trigger signal.
 4. Smart Trigger – Measurements are triggered by pulses of a specified width (smaller or larger than X, or between X & Y).
- Select an external output type:
 1. Video – Observe the pulse or modulation profile directly on external measurement equipment.
 2. Trigger – Provides a TTL output in response to a measured RF pulse, setting logic 1 for the duration of one complete period of the measured RF pulse, or for the duration of the sensor’s sample period if that is shorter. (Applies only when the sensor is operating in internal trigger mode).

FULL SAMPLE PERIOD

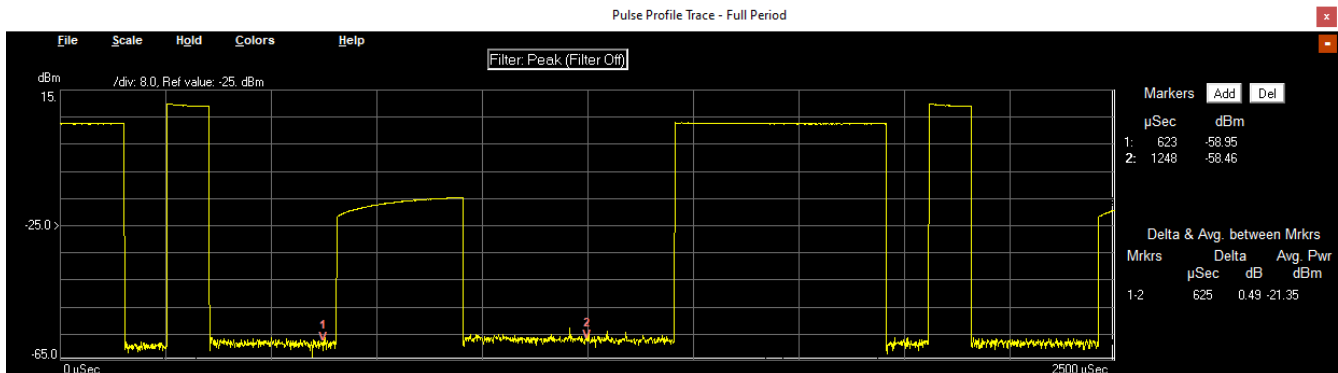

The main pulse profile display shows the full sample period of the sensor in the time domain. Up to four markers can be set as required to measure power levels and calculate time / power deltas.



ZOOM ON PULSE

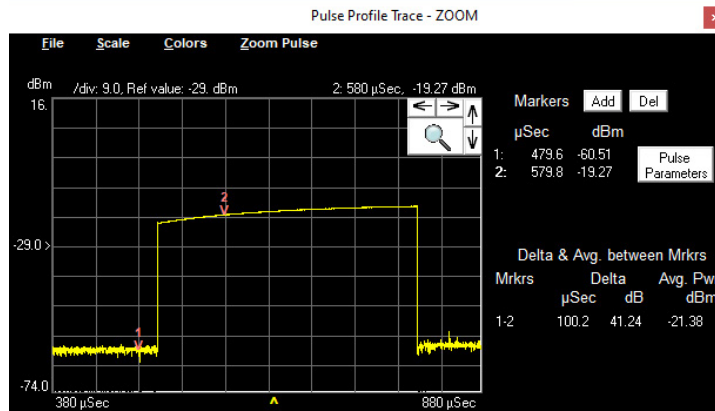

“Zoom on pulse” feature will automatically zoom on the first identified pulse and allows any portion of the pulse profile to be focused on / expanded in a second graphical display. Simply ‘right-click’ and drag the mouse cursor over relevant section of the profile.

For signals with duty cycle greater than 99.9% or under 0.1% the automatic “zoom on pulse” may not work. In such cases, you can adjust the zoom window by clicking on the arrow icons to increment/decrement the trigger delay and span, or the magnifying glass to type in precise values.

CALCULATED PULSE PARAMETERS

The screenshot shows a software window titled "Calculated Parameters". It contains a table with two columns: "Parameter" and "Value".

Parameter	Value
Pulse Width (mSec)	0.044
Pulse Period (mSec)	8.020
Duty Cycle (%)	0.55
Rise Time (μs)	3.54
Fall Time (μs)	3.54
Pulse Pwr (dBm)	0.75
Cycle Avg. (dBm)	-19.70
Crest Factor (dB)	20.45
Over Shoot (dB)	0.98

Full pulse parameters are calculated and displayed in tabular form, including peak / average power, pulse width / period, duty cycle, rise / fall time, crest factor and overshoot.

Note: If “zoom on pulse” window is not showing, the pulse signal calculated parameter may not be correct.



PULSE PROFILING EXAMPLES FOR STANDARD MODULATION TYPES

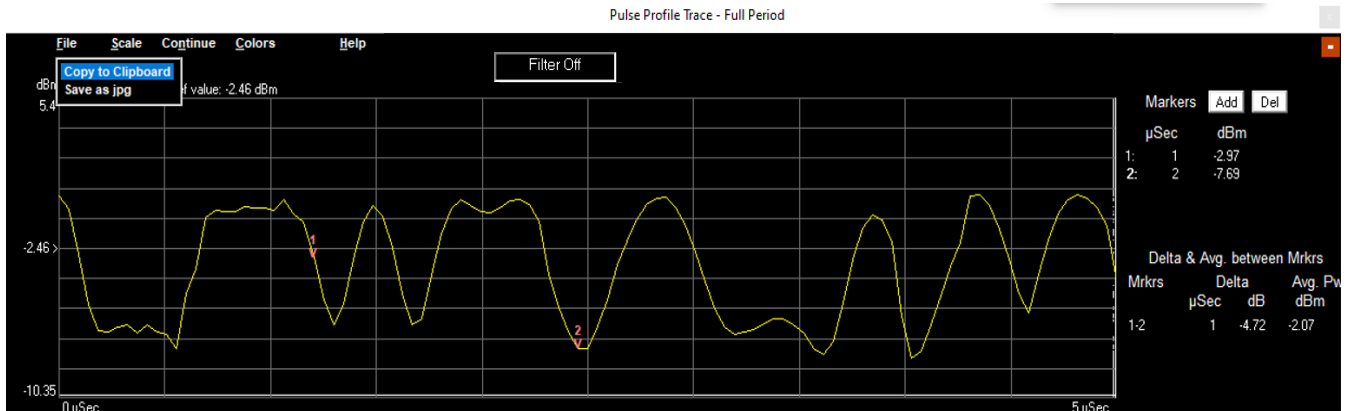

ASK @ 5 Mps

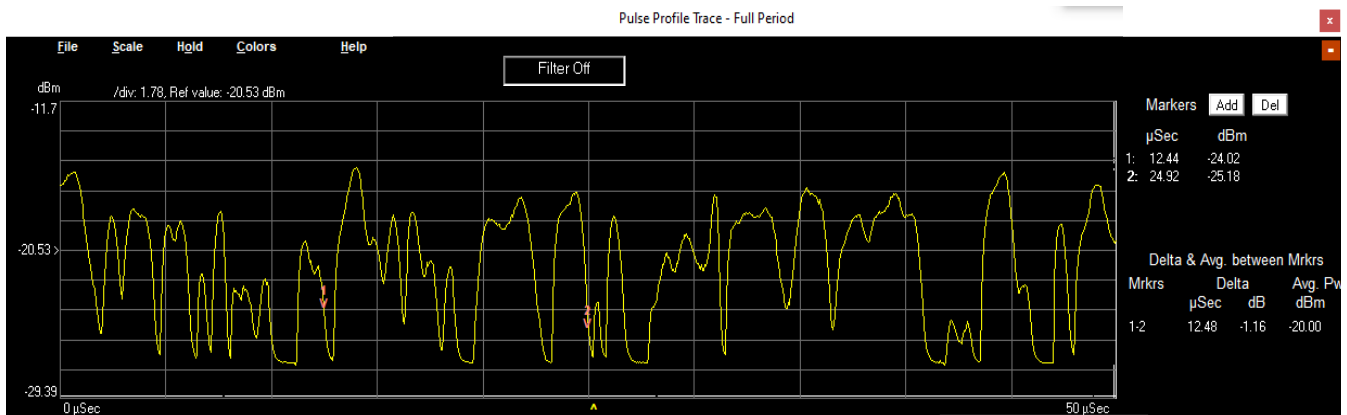

QAM256 in DECT setup, Gaussian filter @ 1.152 Mps

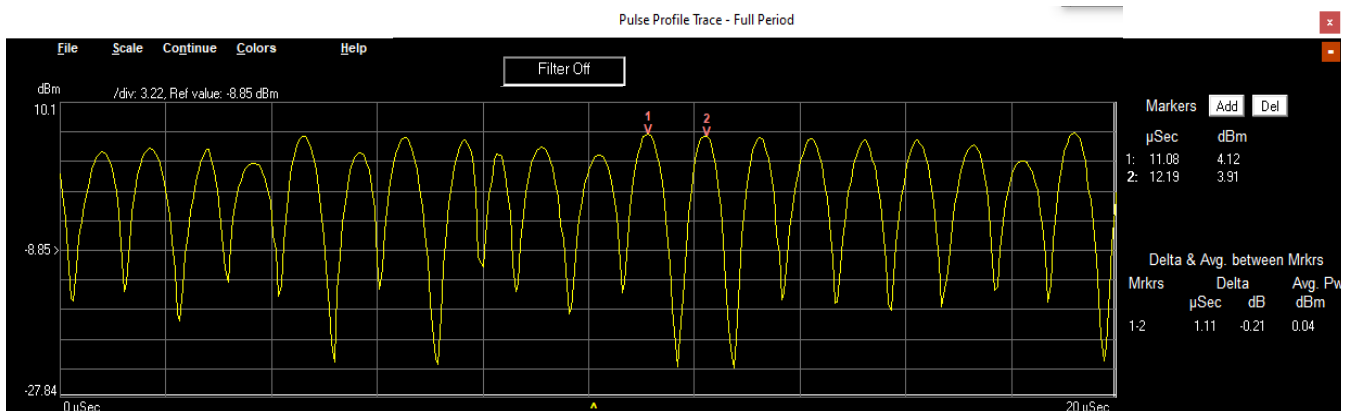

QPSK, QAM16 & QAM64 in LTE uplink setup (1.4 MHz channels, 3.7 MHz offsets) 8 MHz clock



BLOCK DIAGRAM

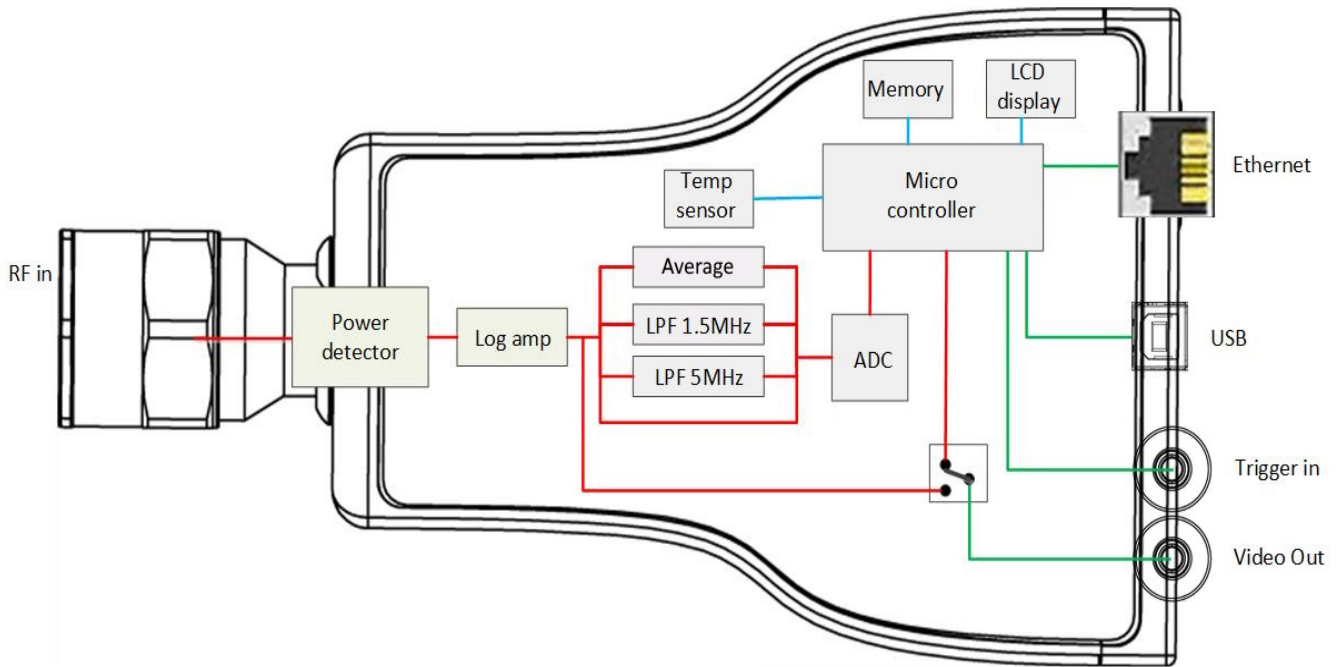

ABSOLUTE MAXIMUM RATINGS ^{15, 16}

Operating Temperature	0°C to +50°C
Storage Temperature	-30°C to +70°C
DC Voltage at RF Ports	5 V
Trigger In	-0.3 to 5.5 V
CW Power	+26 dBm

16. Permanent damage may occur if any of these limits are exceeded.
 17. Operating in the range between operating power limits and absolute maximum ratings for extended periods of time may result in reduced life and reliability.

CONNECTIONS

Port Name	Connector Type
RF Input	N-type Male
Trigger In	SMB Male
Trigger Out	SMB Male
USB	USB type-C (with screw lock)
Ethernet	RJ45 Socket



CASE STYLE DRAWING (JL3470)

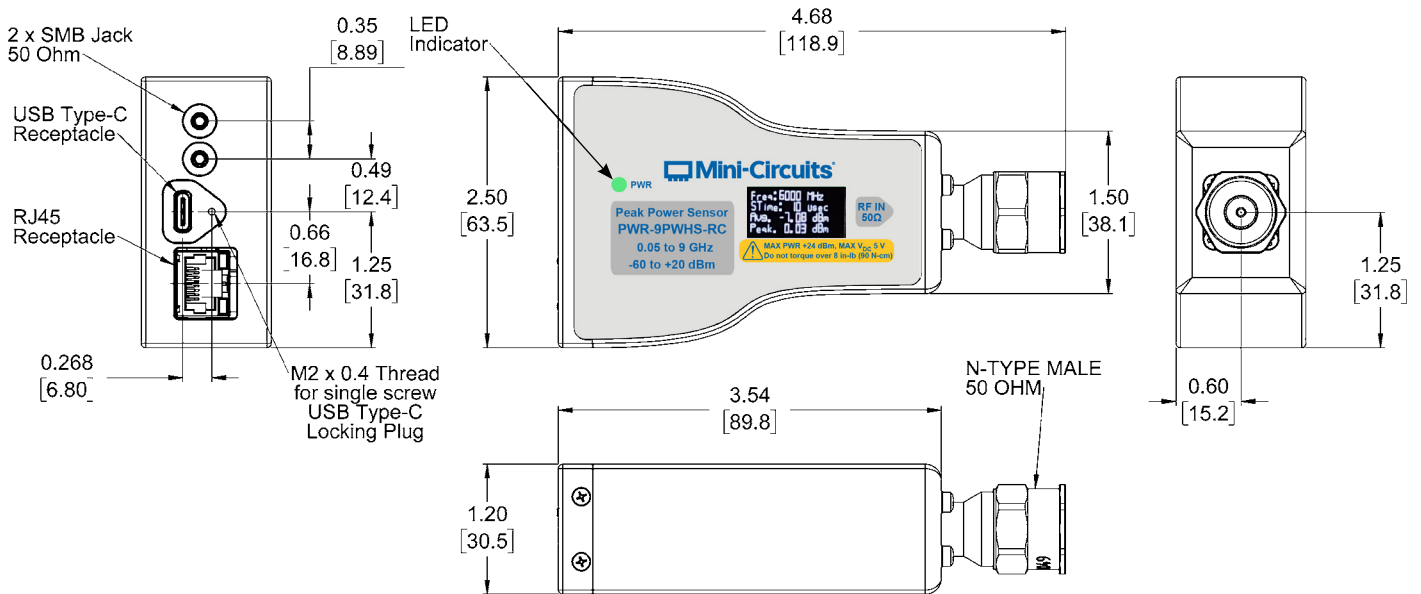

NOTES:

1. Case material: Aluminum alloy.
2. Case Finish: Nickel Plate.
3. Dimensions: Inches [mm].
Tolerances 2 Pl. ±.03 inch; 3 Pl. ±.015 inch.
4. Weight: 260 grams
5. Marking may contain other features or characters for internal lot control.
6. Maximum torque 8 in-lb (90 N-cm).
7. Unit provided with removable protective sleeve (see image below).

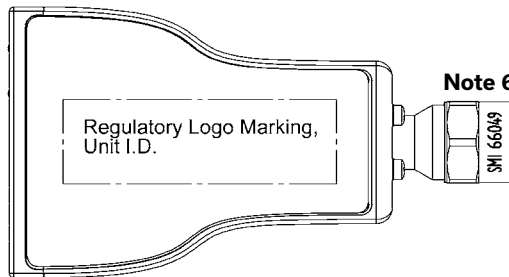

Note 6

Note 7





CONNECTION DIAGRAMS USB CONTROL

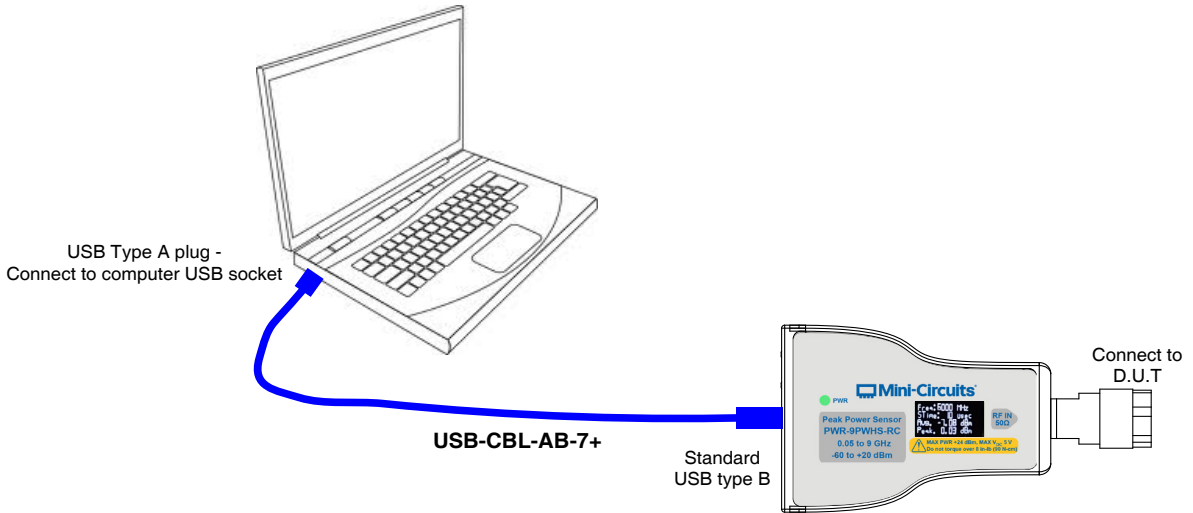

ETHERNET CONTROL (USING POWER ADAPTER)

Connect USB-AC/DC-5
to mains power

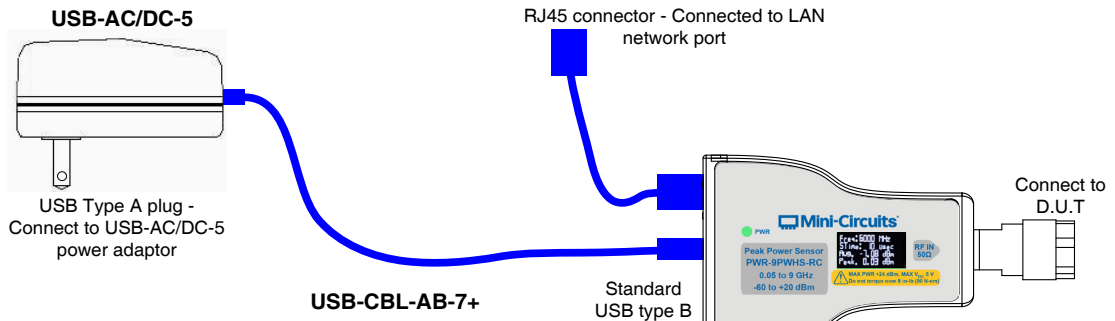

ETHERNET CONTROL (USING POE SYSTEM)

Note:
Commercially available PoE splitter
not supplied by Mini-Circuits.

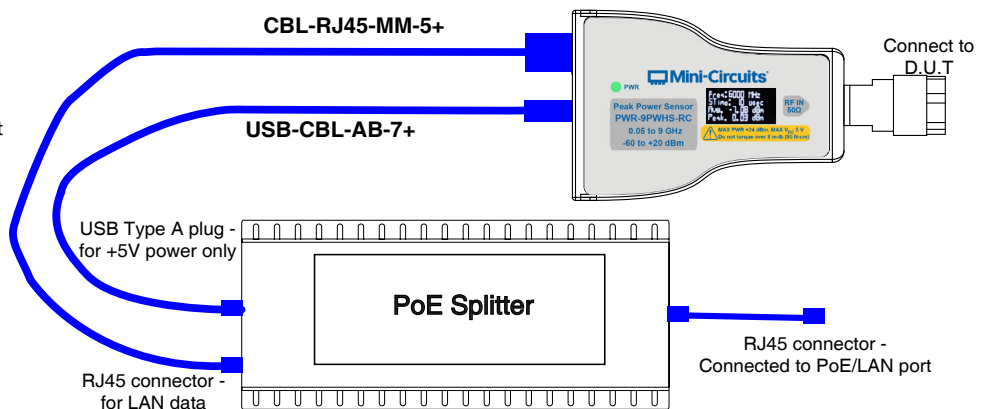



USB & ETHERNET

Smart Power Sensor

PWR-9PWHS-RC





50Ω 50 to 9000 MHz -60 to +20 dBm Peak & Average N-Type Male

DETAILED MODEL INFORMATION IS AVAILABLE ON OUR WEBSITE [CLICK HERE](#)





Performance Data & Graphs	Data Graphs
Case Style	JL3470
Environmental Rating	ENV50
Software, User Guide & Programming Manual	https://www.minicircuits.com/softwaredownload/pm.html
Regulatory Compliance	Refer to user guide for compliance information  https://www.minicircuits.com/app/AN48-003.pdf
Support	testsolutions@minicircuits.com

INCLUDED ACCESSORIES ¹⁸

	Part No.	Description	Qty.
	USB-CBL-AC-7SC+	7.0 ft (2.0 m) USB Cable: USB type A (Male) to USB type C (Male)	1
	CBL-5FT-BMSMB+	5.0 ft (1.5 m) Trigger cable: BNC (Male) to SMB (Female)	1

18. Additional quantities are available for purchase as optional accessories.

OPTIONAL ACCESSORIES

	Part No.	Description
	CBL-RJ45-MM-5+	5.0 ft (1.5 m) Ethernet cable: RJ45 (Male) to RJ45 (Male) Cat 5E cable
	NF-SF50+	N-Type Female to SMA Female Adapter
	NF-SM50+	N-Type Female to SMA Male Adapter
	NF-BM50+	N-Type Female to BNC Male Adapter
	USB-AC/DC-5+	AC/DC +5V power adaptor with USB connector ^{19,20}

19. Includes power plugs for US, UK, EU, IL, AU & China. Plugs for other countries are also available. If you need a power cord for a country not listed please contact testsolutions@minicircuits.com

20. Power adaptor, powered hub or USB 3.0/3.1 port may be used to provide power when in Ethernet control, not needed in USB control.

CALIBRATION

Part No.	Description
CALSEN-9PWHS-RC	Calibration Service for PWR-9PWHS-RC CLICK HERE

NOTES:

- A. Performance and quality attributes and conditions not expressly stated in this specification document are intended to be excluded and do not form a part of this specification document.
- B. Electrical specifications and performance data contained in this specification document are based on Mini-Circuit's applicable established test performance criteria and measurement instructions.
- C. The parts covered by this specification document are subject to Mini-Circuits standard limited warranty and terms and conditions (collectively, "Standard Terms"); Purchasers of this part are entitled to the rights and benefits contained therein. For a full statement of the Standard Terms and the exclusive rights and remedies thereunder, please visit Mini-Circuits' website at <https://www.minicircuits.com/terms/viewterm.html>

