



MMIC SURFACE MOUNT

# Power Amplifier

## PMA3-73-1W+

50Ω 300 to 7500 MHz 1 W Output Power

### THE BIG DEAL

- High P1dB, Typ. +31.7 dBm
- High P<sub>SAT</sub>, Typ. +33.5 dBm
- Low Noise Figure, Typ. 2.5 dB
- High OIP3, Typ. +37 dBm
- Single Supply Voltage, +12 V @ 190 mA
- 3x3 mm 12-Lead QFN-Style Package



Generic photo used for illustration purposes only

### APPLICATIONS

- Test and Measurement Equipment
- Radar, EW, and ECM Defense Systems
- 5G Sub6, MIMO Wireless Infrastructure Systems
- Microwave Radio & VSAT

### FUNCTIONAL DIAGRAM

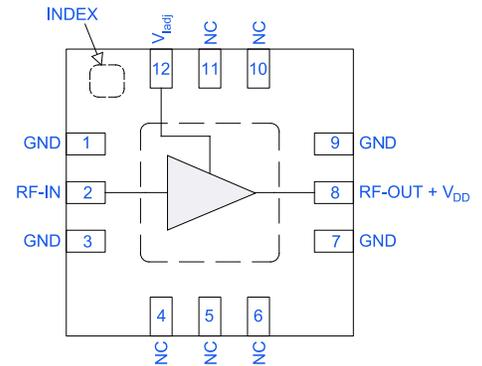

### PRODUCT OVERVIEW

The PMA3-73-1W+ is a GaAs MMIC Power Amplifier operating from 300 to 7500 MHz. The amplifier provides 20.1 dB of gain, +33.5 dBm saturated output power, and achieves +37 dBm output IP3, while operating from a single +12 V power supply. In addition, it is internally matched to 50 Ohms and comes in a 3x3 mm 12-Lead QFN-style package. These characteristics make it ideally suited for wideband test instrumentation and defense systems that require high operating output power, while maintaining very low distortion characteristics.

### KEY FEATURES

Feature	Advantages
High P1dB Typ. +31.7 dBm	Flat gain and output power make this device excellent for wideband systems from 300 to 7500 MHz that require at least 1 W of operating output power over the full band.
Low Noise Figure Typ. 2.5 dB	High operating output power accompanied by low noise figure enables a significant signal to noise ratio advantage for systems requiring high dynamic range.
High OIP3 Typ. +37 dBm	High operating OIP3, as well as low 2nd and 3rd harmonic responses, provide very low in-band distortion products, which are typically needed for high fidelity measurement systems.
3x3 mm 12-Lead QFN-Style Package	Small footprint saves space in dense layouts while providing low inductance, repeatable transitions, and excellent thermal contact to the PCB. Industry standard packaging allows for ease of assembly in high volume manufacturing processes.





MMIC SURFACE MOUNT

# Power Amplifier

## PMA3-73-1W+

Mini-Circuits

50Ω 300 to 7500 MHz 1 W Output Power

### ELECTRICAL SPECIFICATIONS<sup>1</sup> AT +25°C, V<sub>DD</sub> = +12 V, V<sub>ladj</sub> = OPEN, UNLESS NOTED OTHERWISE

Parameter	Condition (MHz)	Min.	Typ.	Max.	Units
Frequency Range		300		7500	MHz
Gain	300	20.0	21.3		dB
	2000	20.0	21.3		
	4000	18.2	20.1		
	6000	17.5	19.3		
	7500	16.4	19.8		
Isolation	300 - 7500		29		dB
Input Return Loss	300		12		dB
	2000		13		
	4000		12		
	6000		8		
	7500		14		
Output Return Loss	300		8		dB
	2000		14		
	4000		12		
	6000		9		
	7500		18		
Output Power at 1 dB Compression (P <sub>1dB</sub> )	300		+30.3		dBm
	2000		+32.1		
	4000		+31.7		
	6000		+29.0		
	7500		+25.3		
Output Power at Saturation (P <sub>SAT</sub> ) <sup>2</sup>	300		+30.5		dBm
	2000		+32.4		
	4000		+33.5		
	6000		+32.2		
	7500		+31.2		
Output Third-Order Intercept (P <sub>OUT</sub> = +18 dBm/Tone)	300		+36		dBm
	2000		+38		
	4000		+37		
	6000		+36		
	7500		+36		
2nd Harmonics (P <sub>OUT</sub> = +18 dBm)	300		-30		dBc
	2000		-24		
	4000		-28		
	6000		-44		
	7500		-57		
3rd Harmonics (P <sub>OUT</sub> = +18 dBm)	300		-45		dBc
	2000		-45		
	4000		-53		
	6000		-52		
	7500		-44		





MMIC SURFACE MOUNT

# Power Amplifier

## PMA3-73-1W+

50Ω 300 to 7500 MHz 1 W Output Power

### ELECTRICAL SPECIFICATIONS<sup>1</sup> AT +25°C, V<sub>DD</sub> = +12 V, V<sub>ladj</sub> = OPEN, UNLESS NOTED OTHERWISE

Parameter	Condition (MHz)	Min.	Typ.	Max.	Units
Noise Figure	300		3.8		dB
	2000		2.8		
	4000		2.5		
	6000		2.3		
	7500		2.8		
Device Operating Voltage (V <sub>DD</sub> )		+10	+12	+12.5	V
Device Operating Current (I <sub>DD</sub> ) <sup>3</sup>			190		mA
DC Current Variation vs. Temperature <sup>4</sup>			-96		μA/°C
DC Current Variation vs. V <sub>DD</sub> <sup>5</sup>			0.024		mA/mV
DC Current Variation vs. V <sub>ladj</sub> <sup>6</sup>			0.057		mA/mV

1. Tested on Mini-Circuits Characterization Test Board TB-PMA3-73-1WC+. See Figure 2. Board loss de-embedded.
2. P<sub>SAT</sub> defined as when the Output Power changes 0.1 dB per 1 dB change in Input Power.
3. Current at P<sub>IN</sub> = -25 dBm. Increases to ~550 mA at P1dB.
4. (Current at +85°C - Current at -55°C)/(140°C).
5. (Current at V<sub>DD</sub> = +12.5 V - Current at V<sub>DD</sub> = +10 V)/(+2.5 V). V<sub>ladj</sub> kept open.
6. (Current at V<sub>ladj</sub> = +1.8 V - Current at V<sub>ladj</sub> = +0.8 V)/(+1.0 V). V<sub>DD</sub> kept constant.



MMIC SURFACE MOUNT

# Power Amplifier

## PMA3-73-1W+

Mini-Circuits

50Ω 300 to 7500 MHz 1 W Output Power

### TYPICAL PERFORMANCE GRAPHS

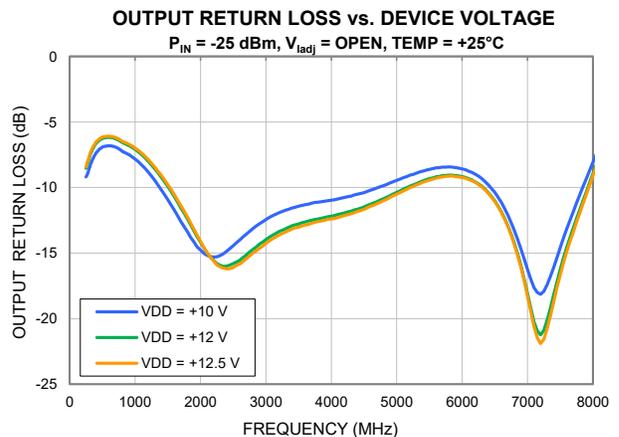
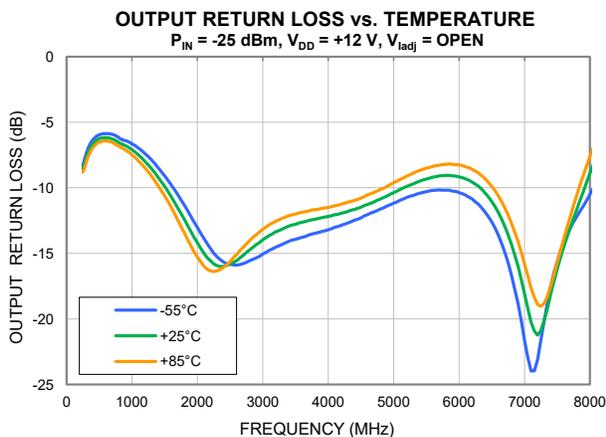
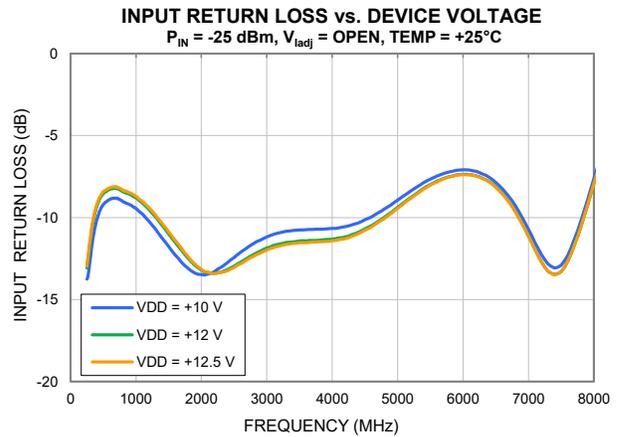
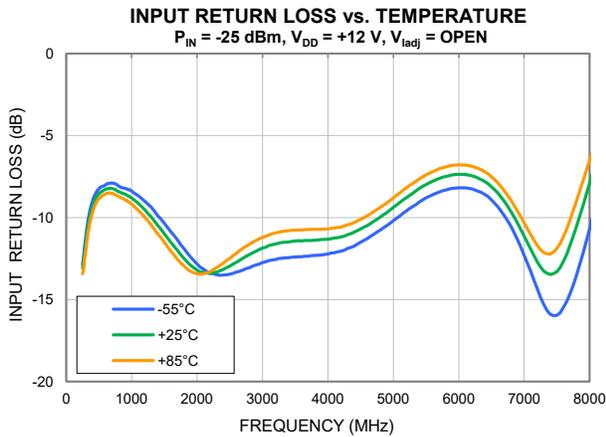
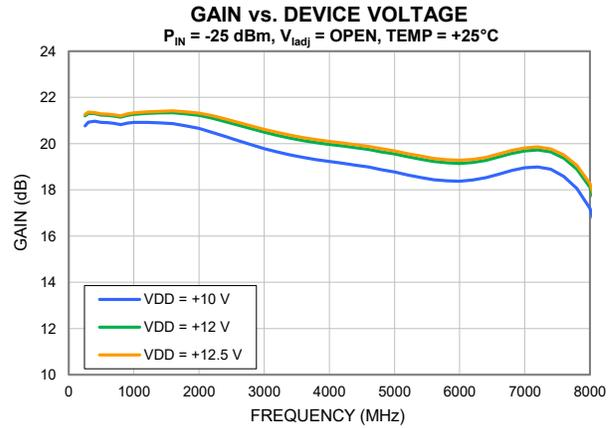
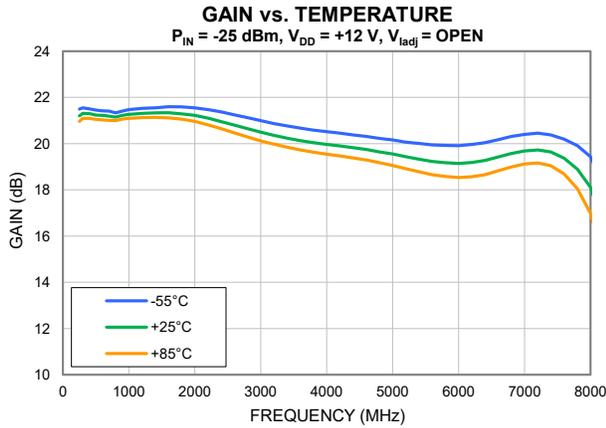



### TYPICAL PERFORMANCE GRAPHS

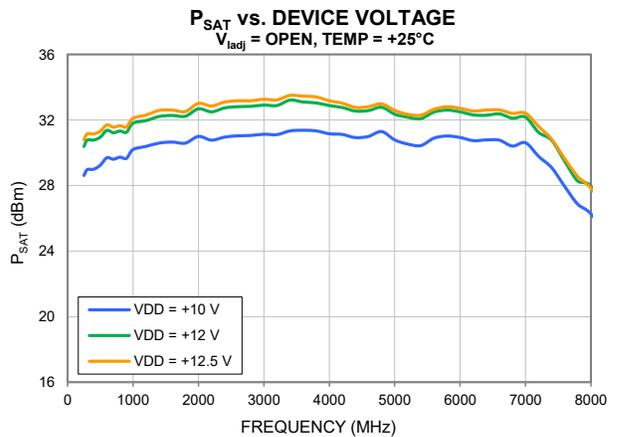
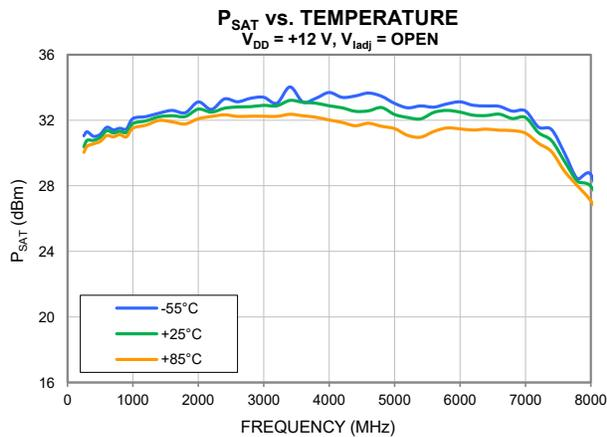
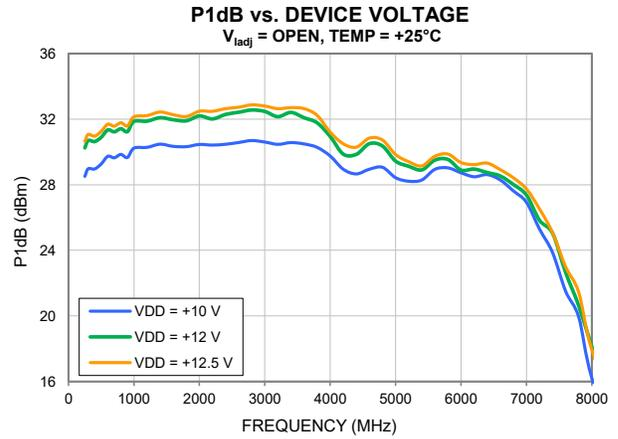
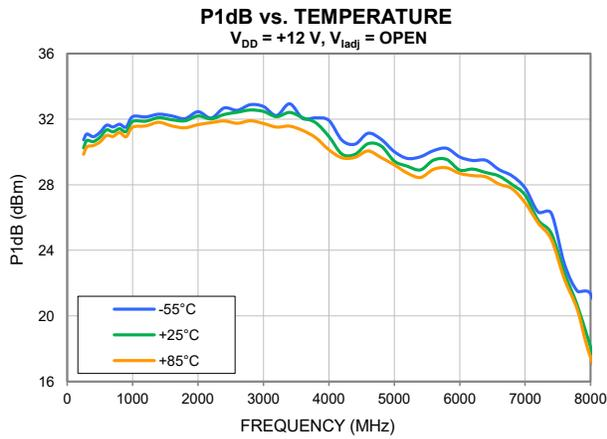
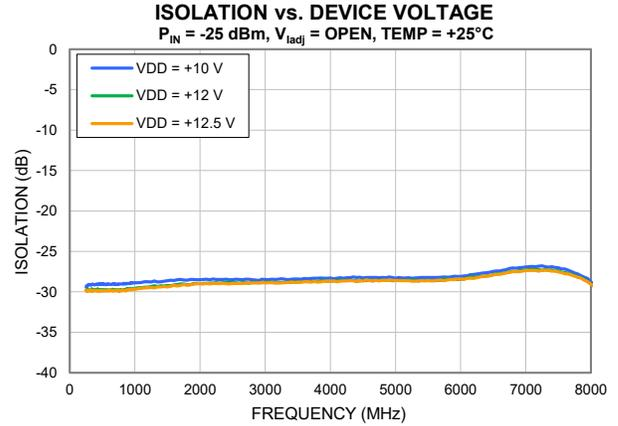
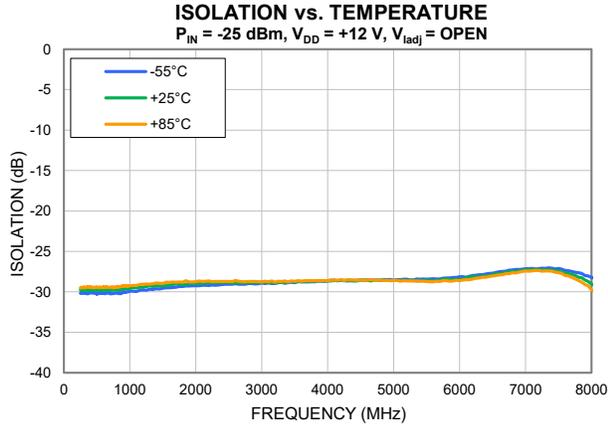



### TYPICAL PERFORMANCE GRAPHS

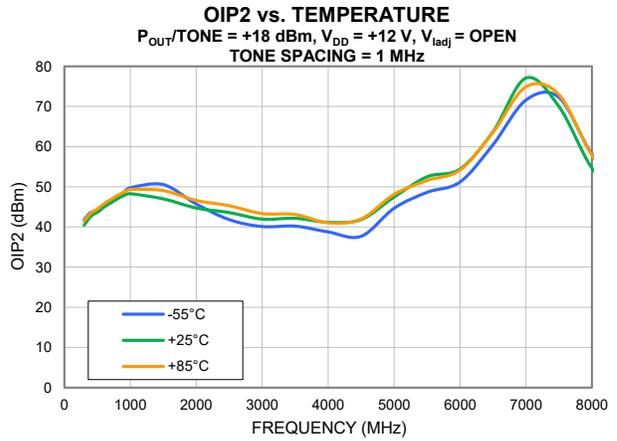
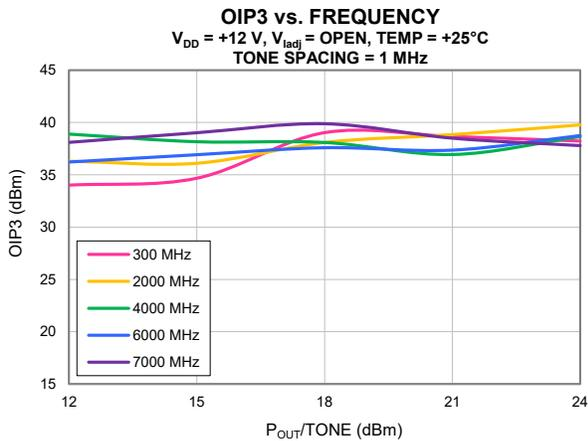
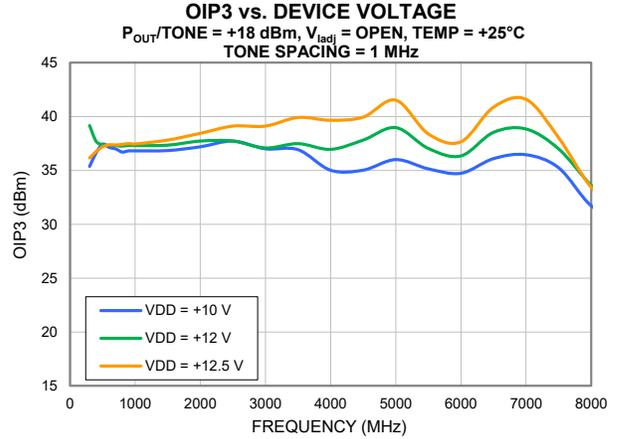
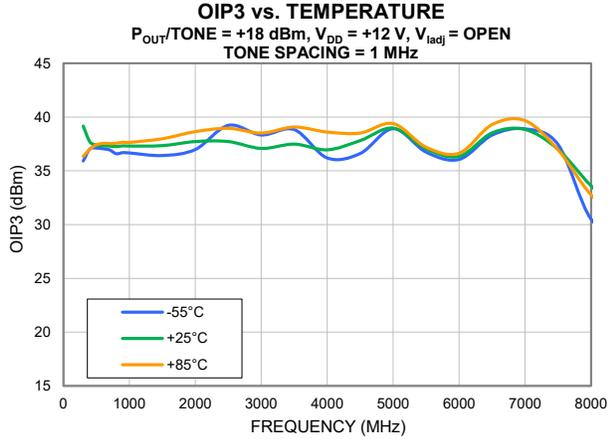



### TYPICAL PERFORMANCE GRAPHS

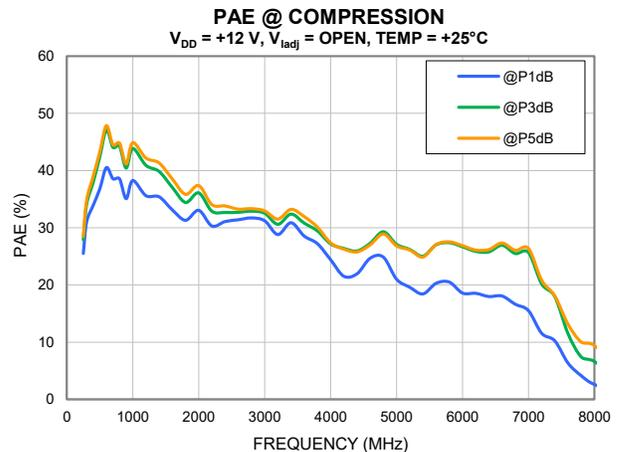
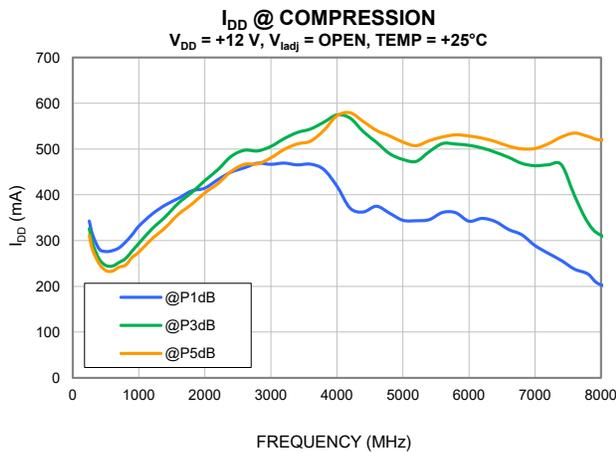
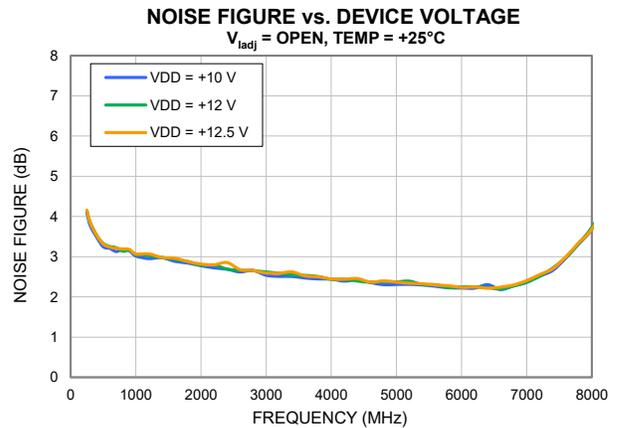
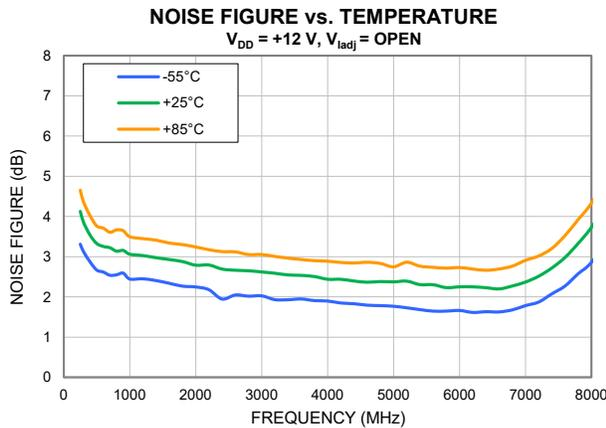
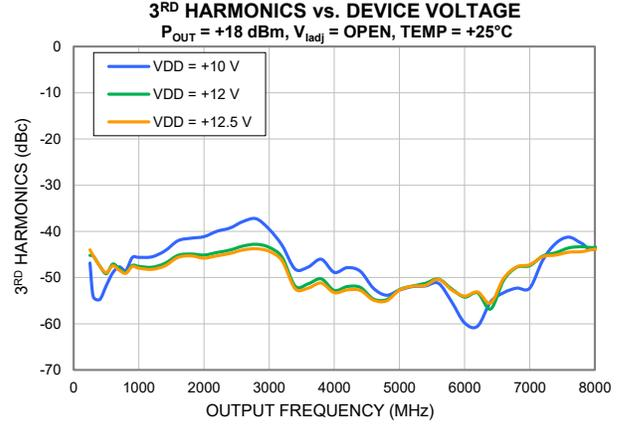
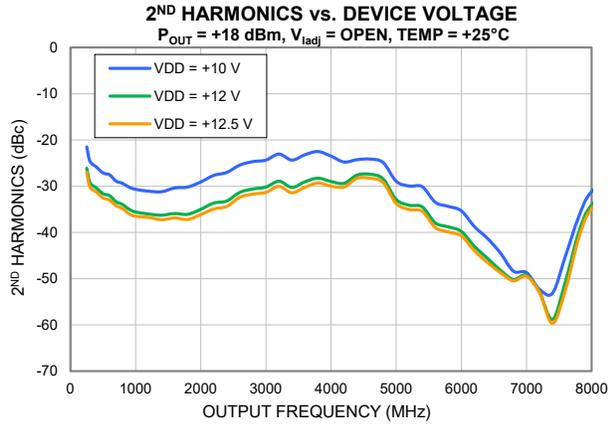



### TYPICAL PERFORMANCE GRAPHS

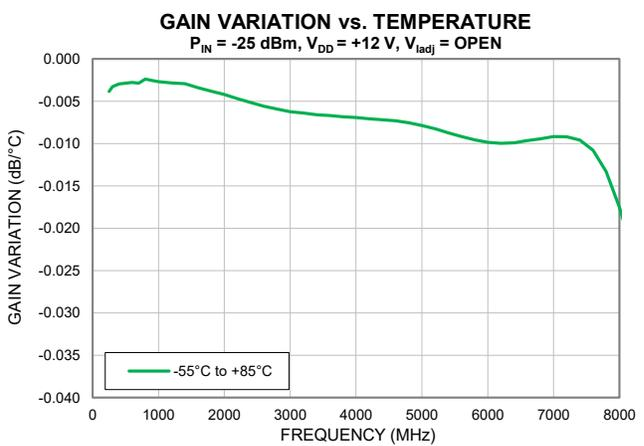
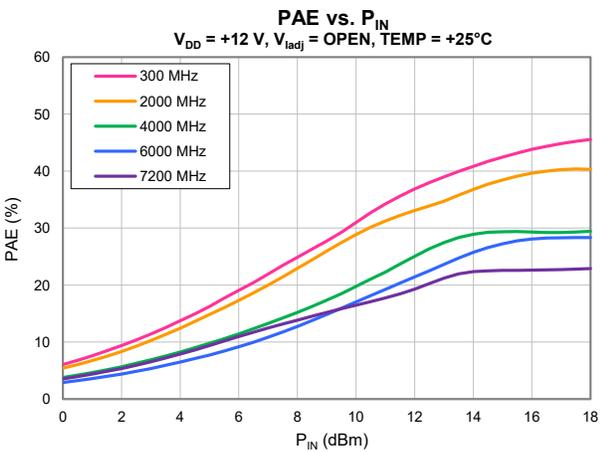
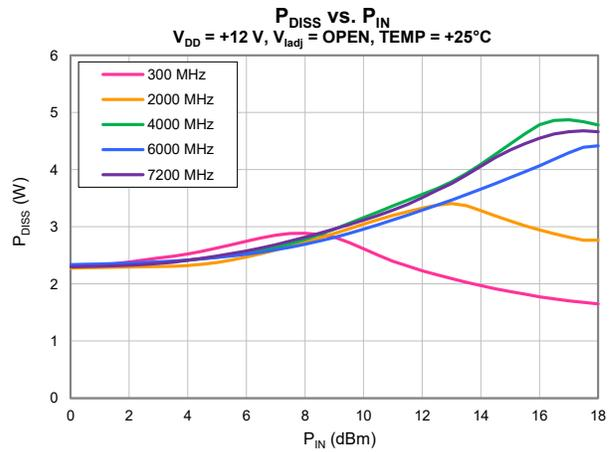
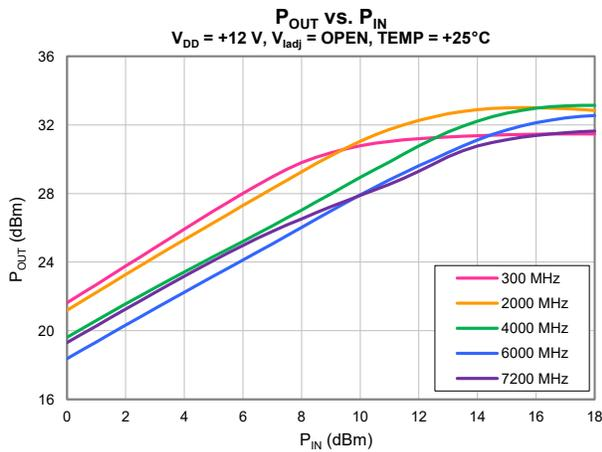
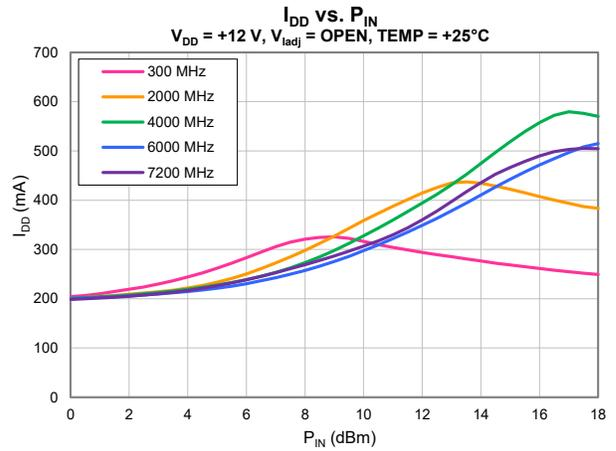
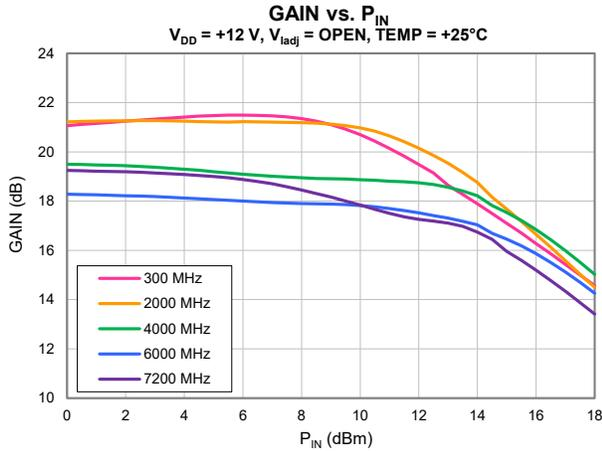



### TYPICAL PERFORMANCE GRAPHS

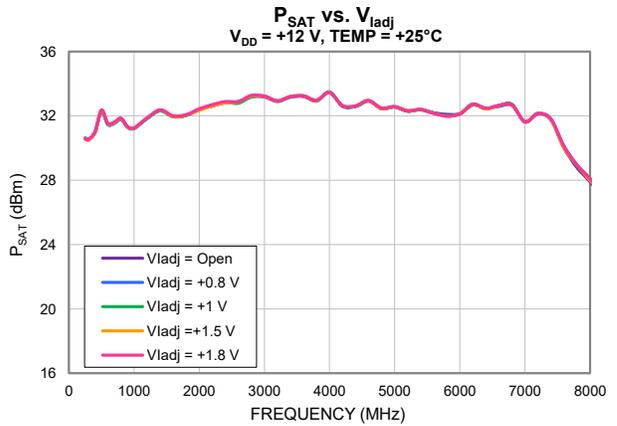
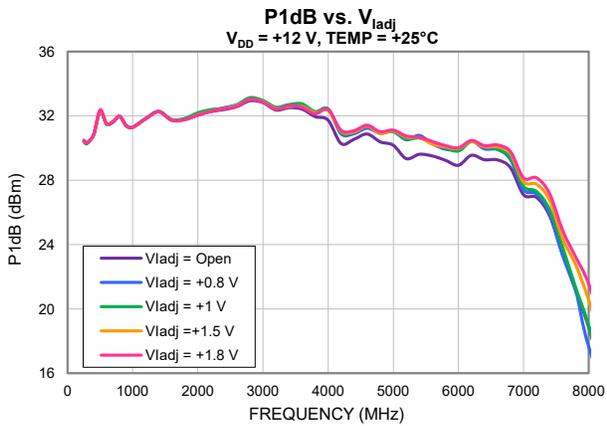
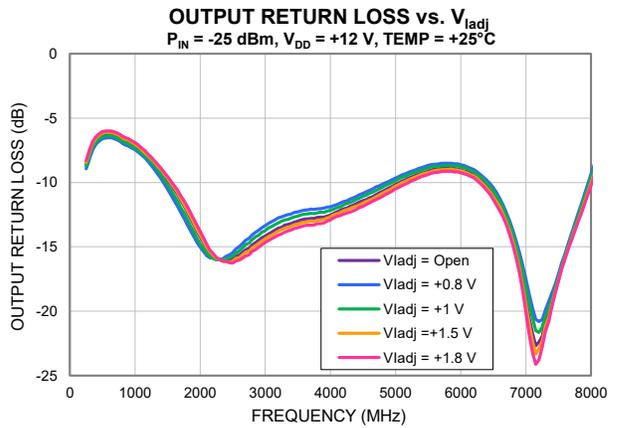
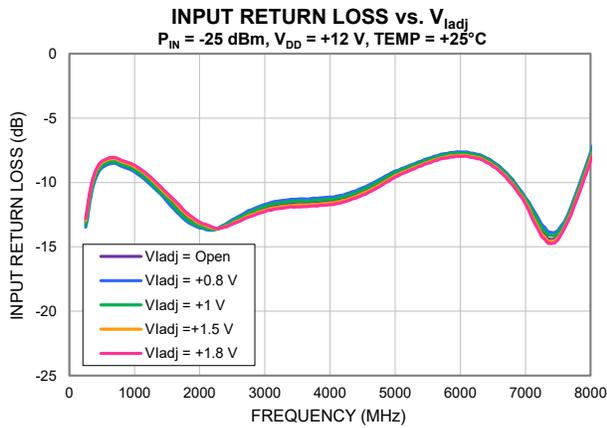
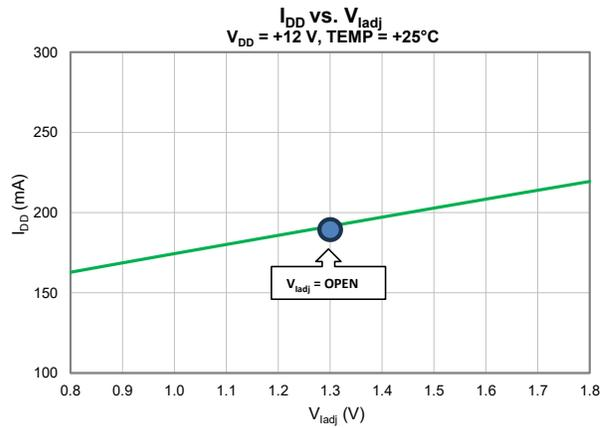
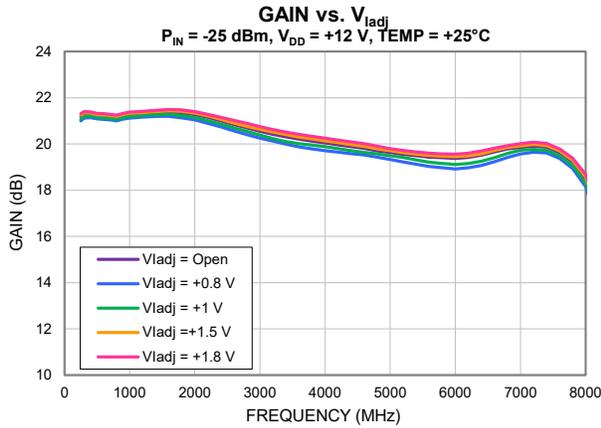



MMIC SURFACE MOUNT

# Power Amplifier

## PMA3-73-1W+

Mini-Circuits

50Ω 300 to 7500 MHz 1 W Output Power

### TYPICAL PERFORMANCE GRAPHS

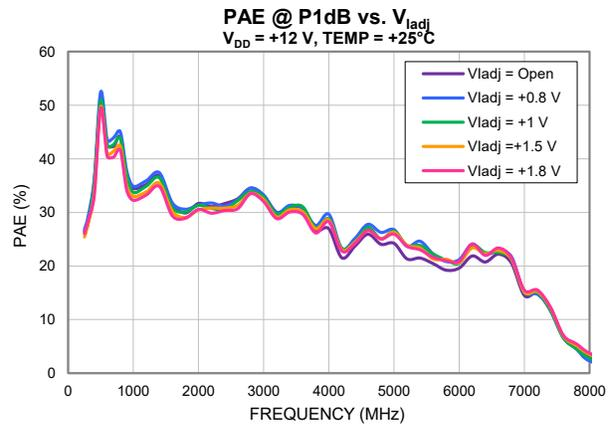
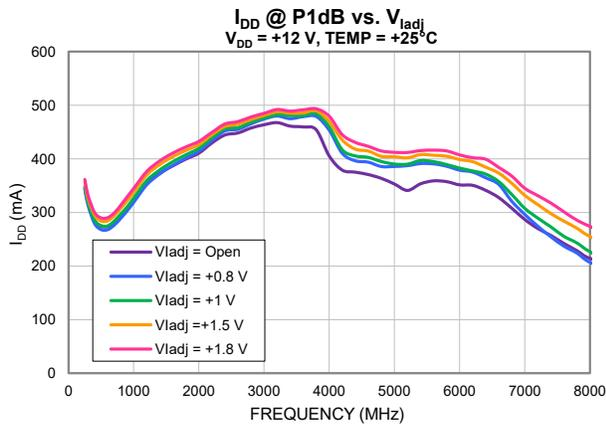
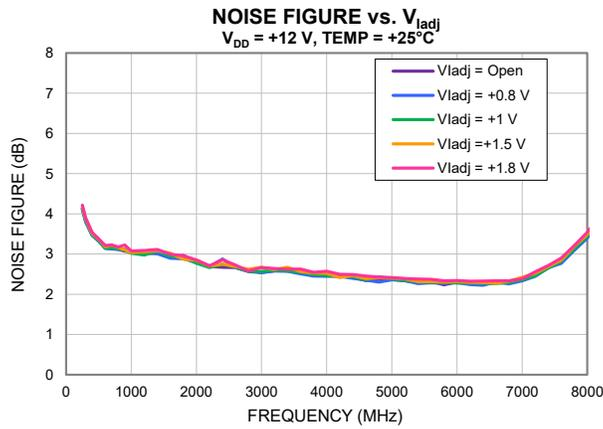
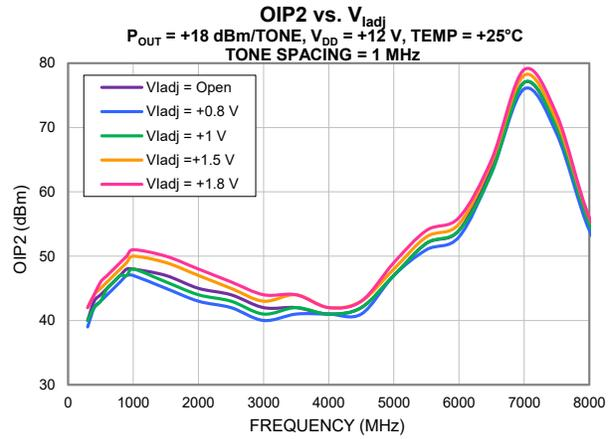
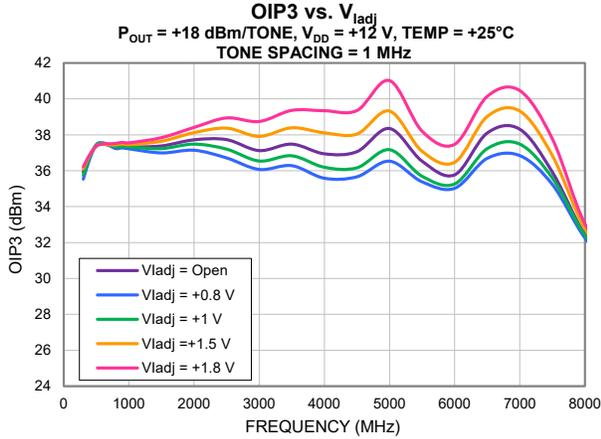



MMIC SURFACE MOUNT

# Power Amplifier

## PMA3-73-1W+

Mini-Circuits

50Ω 300 to 7500 MHz 1 W Output Power

### ABSOLUTE MAXIMUM RATINGS<sup>7</sup>

Parameter	Ratings
Operating Temperature (ground lead)	-55°C to +85°C
Storage Temperature	-65°C to +150°C
Junction Temperature <sup>8</sup>	+175°C
Total Power Dissipation	5.5 W
Input Power (CW), $V_{DD} = +12$ V	+24 dBm
DC Voltage at RF-OUT + $V_{DD}$	+18 V
DC Voltage at $V_{Iadj}$	+6 V

7. Permanent damage may occur if any of these limits are exceeded. Maximum ratings are not intended for continuous normal operation.

8. Peak temperature on top of Die.

### THERMAL RESISTANCE

Parameter	Ratings
Thermal Resistance ( $\Theta_{JC}$ ) <sup>9</sup>	12.9°C/W

9.  $\Theta_{JC}$  = (Hot Spot Temperature on Die - Temperature at Ground Lead)/Dissipated Power

### ESD RATING

	Class	Voltage Range	Reference Standard
HBM	1A	250 V to <500 V	ANSI/ESDA/JEDEC JS-001-2023
CDM	C3	> 1000 V	ANSI/ESDA/JEDEC JS-001-2022



ESD HANDLING PRECAUTION: This device is designed to be Class 1A for HBM. Static charges may easily produce potentials higher than this with improper handling and can discharge into DUT and damage it. As a preventive measure Industry standard ESD handling precautions should be used at all times to protect the device from ESD damage.

### MSL RATING

Moisture Sensitivity: MSL1 in accordance with IPC/JEDEC J-STD-020E/JEDEC J-STD-033C





### FUNCTIONAL DIAGRAM

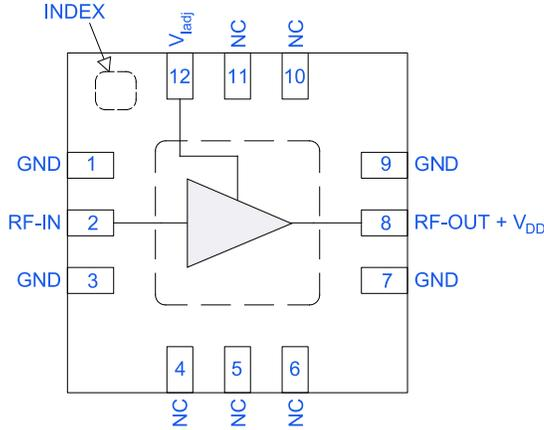

Figure 1. PMA3-73-1W+ Functional Diagram

### PAD DESCRIPTION

Function	Pad Number	Description (Refer to Figure 2)
RF-IN	2	RF-IN Pad connects to RF Input port.
RF-OUT + V <sub>DD</sub>	8	RF-OUT Pad connects to RF Output port. V <sub>DD</sub> is applied via external bias tee.
V <sub>adj</sub>	12	Voltage Adjust Pad to set I <sub>DD</sub> current level.
NC	4-6, 10-11	Not used internally. Connected to ground on test board.
GND	1, 3, 7, 9, Index, & Paddle	Connects to ground.

### CHARACTERIZATION TEST BOARD

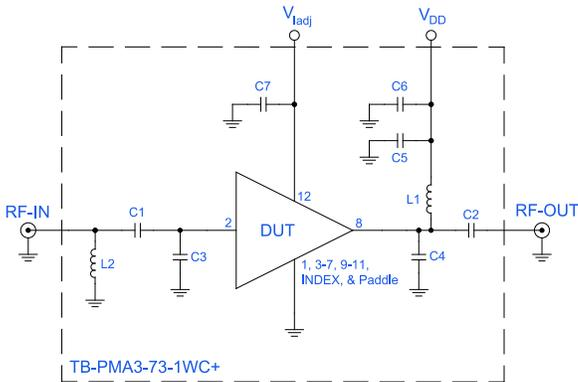

Figure 2. PMA3-73-1W+ Evaluation and Characterization Circuit

### Electrical Parameters and Conditions

Gain, Return Loss, Output Power at 1 dB Compression (P<sub>1dB</sub>), Output IP3 (OIP3), and Noise Figure measured using N5245A PNA-X Microwave Network Analyzer.

#### Conditions:

1. Gain and Return Loss: P<sub>IN</sub> = -25 dBm
2. Output IP3 (OIP3): Two tones, spaced 1 MHz apart, +18 dBm/Tone at output.

Component	Value	Size	Part Number	Manufacturer
C1, C2, C5	1000 pF	0402	GRM1555C1H102JA01D	Murata
C3, C4	0.4 pF	0402	GJM1555C1HR40WB01D	Murata
C6, C7	0.1 μF	0402	GRM155R71H104KE14J	Murata
L1	20 nH	0402	0402HP-20NXGRW	Coilcraft
L2	25 nH	0402	0402HP-25NXJRW	Coilcraft



MMIC SURFACE MOUNT

# Power Amplifier

## PMA3-73-1W+

Mini-Circuits

50Ω 300 to 7500 MHz 1 W Output Power

### CASE STYLE DRAWING

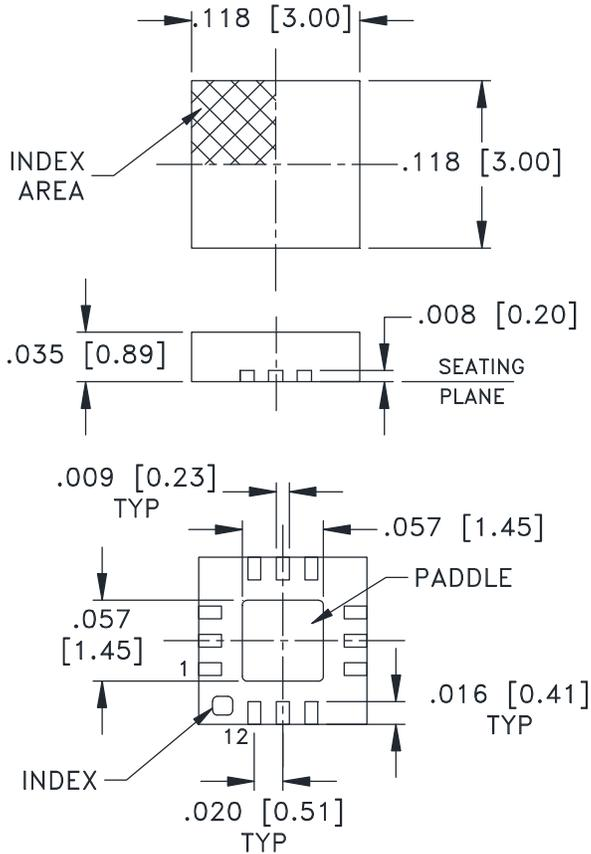

### PCB Land Pattern

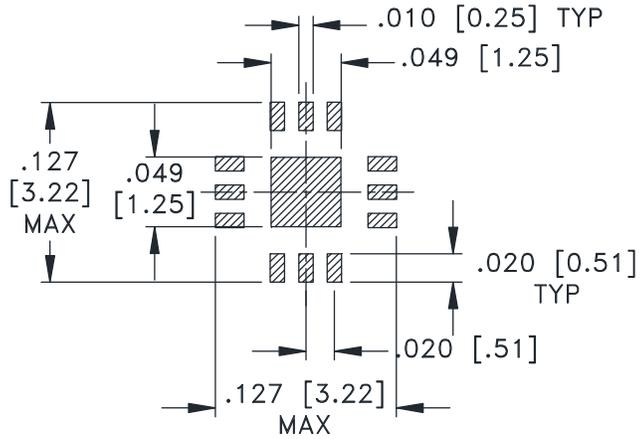

SUGGESTED LAYOUT,  
TOLERANCE TO BE WITHIN ±.002

Weight: .02 Grams

Dimensions are in inches [mm]. Tolerances in inches: 2 Pl. ±.01; 3 Pl.±.004 inches

### PRODUCT MARKING

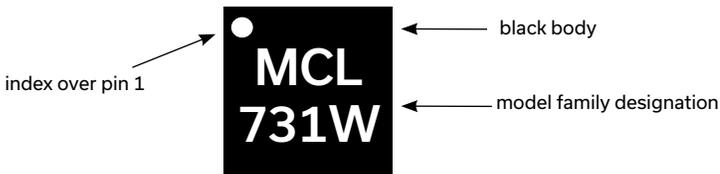

Marking may contain other features or characters for internal lot control





MMIC SURFACE MOUNT

# Power Amplifier

## PMA3-73-1W+

50Ω 300 to 7500 MHz 1 W Output Power

ADDITIONAL DETAILED INFORMATION IS AVAILABLE ON OUR DASHBOARD [CLICK HERE](#)

Performance Data & Graphs	Data
	Graphs
	S-Parameter (S2P Files) Data Set (.zip file)
Case Style	DQ1225 Plastic package, exposed paddle, lead finish: Matte-Tin
RoHS Status	Compliant
Tape & Reel	F66
Standard quantities available on reel	7" reels with 20, 50, 100, 200, 500, 1K, 2K, or 3K devices
Suggested Layout for PCB Design	PL-813
Evaluation Board	TB-PMA3-73-1WC+
	Gerber File
Environmental Ratings	ENV08T1

### NOTES

- A. Performance and quality attributes and conditions not expressly stated in this specification document are intended to be excluded and do not form a part of this specification document.
- B. Electrical specifications and performance data contained in this specification document are based on Mini-Circuit's applicable established test performance criteria and measurement instructions.
- C. The parts covered by this specification document are subject to Mini-Circuits standard limited warranty and terms and conditions (collectively, "Standard Terms"); Purchasers of this part are entitled to the rights and benefits contained therein. For a full statement of the standard terms and the exclusive rights and remedies thereunder, please visit Mini-Circuits' website at [www.minicircuits.com/terms/viewterm.html](http://www.minicircuits.com/terms/viewterm.html)

