



MMIC SURFACE MOUNT

Low Noise Amplifier

PMA3-5153+

50Ω 5.5 to 15.5 GHz Shutdown Feature

THE BIG DEAL

- Low Noise Figure, Typ. 1.2 dB
- High OIP3, Typ. +28.4 dBm
- High P1dB, Typ. +17 dBm
- Shutdown Feature
- Single Supply Voltage, +5 V & 64 mA
- 3x3 mm, 16-Lead QFN-Style Package

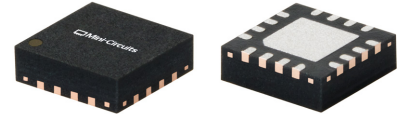

Generic photo used for illustration purposes only

APPLICATIONS

- Test & Measurement Equipment
- Back Haul Radio Systems
- Satellite Communications
- Radar, EW, and ECM Defense Systems

FUNCTIONAL DIAGRAM

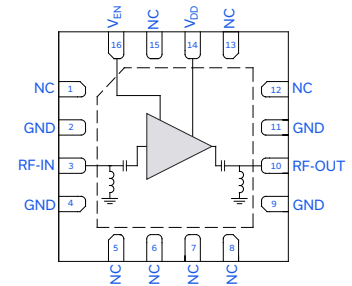

PRODUCT OVERVIEW

The PMA3-5153+ is a pHEMT-based, wideband, ultra-low noise MMIC amplifier with high IP3, flat gain, and voltage-controlled shutdown capability. Operating from 5.5 to 15.5 GHz, this amplifier features high dynamic range with 1.2 dB typical noise figure, 21.5 dB gain, +17 dBm P1dB, and +28.4 dBm OIP3. This combination of characteristics makes it ideal for sensitive, high dynamic range receiver applications. The device is internally DC blocked, and a DC path to ground is present at the RF input and output ports for ESD protection. PMA3-5153+ operates on a single +5 V supply, is well matched to 50Ω, and comes in a small, low profile 3x3 mm QFN-style package for easy integration into dense circuit board layouts.

KEY FEATURES

Features	Advantages
Low Noise Figure, Typ. 1.2 dB	This ultra-low noise MMIC device enables low system noise figure performance without the need for complicated discrete-based solutions.
High Dynamic Range: <ul style="list-style-type: none"> • OIP3, Typ. +28.4 dBm • P1dB, Typ. +17 dBm 	The MMIC amplifier's unique combination of low noise figure, high P1dB, and high OIP3 enables optimum performance in sensitive high dynamic range receivers.
Shutdown Feature	A shutdown feature allows the part to be quickly disabled to conserve power when not in use.
3x3 mm 16-Lead QFN-Style Package	Small footprint saves space in dense layouts while providing low inductance, repeatable transitions, and excellent thermal contact to the PCB. Industry standard packaging allows for ease of assembly in high volume manufacturing processes.





MMIC SURFACE MOUNT

Low Noise Amplifier

PMA3-5153+

50Ω 5.5 to 15.5 GHz Shutdown Feature

ELECTRICAL SPECIFICATIONS¹ AT +25°C, V_{DD} = +5 V, V_{EN} = +5 V UNLESS NOTED OTHERWISE

Parameter	Condition (GHz)	Min.	Typ.	Max.	Units
Frequency Range		5.5		15.5	GHz
Gain	5.5	19.6	21.2		dB
	8	18.8	20.8		
	10	19.5	21.5		
	13	19.9	21.7		
	15.5	18.0	19.9		
Input Return Loss	5.5		10		dB
	8		15		
	10		10		
	13		8		
	15.5		19		
Output Return Loss	5.5		15		dB
	8		15		
	10		14		
	13		18		
	15.5		6		
Isolation	5.5 - 15.5		50		dB
Output Power at 1 dB Compression (P _{1dB})	5.5		+16.1		dBm
	8		+16.6		
	10		+17.0		
	13		+16.5		
	15.5		+18.3		
Output Third-Order Intercept (P _{OUT} = +5 dBm/Tone)	5.5		+27.5		dBm
	8		+29.1		
	10		+28.4		
	13		+25.9		
	15.5		+26.2		
Noise Figure	5.5		1.1		dB
	8		1.1		
	10		1.2		
	13		1.3		
	15.5		1.5		
FALL Time (90% RF to 10% RF) ²			13		ns
RISE Time (10% RF to 90% RF) ²			143		ns
Device Operating Voltage (V _{DD})		+4.75	+5.0	+5.25	V
Device Operating Current (I _{DD}) ³			64		mA
Device Enable Voltage (V _{EN}) ⁴		+4.75	+5.0	+5.25	V
Device Enable Current (I _{EN}) at V _{EN} = +5 V			0.83		mA
DC Current Variation vs. Temperature ⁵			-86.67		μA/°C
DC Current Variation vs. Voltage ⁶			0.005		mA/mV

1. Tested on Mini-Circuits Characterization Test Board TB-PMA3-5153C+. See Figure 2. Board loss de-embedded to the device.

2. Measured with bypass capacitor C2 removed from TB-PMA3-5153C+.

3. Current at P_N = -25 dBm. Increases to 72 mA at P_{1dB}.

4. V_{EN} ≤ V_{DD} under nominal operating conditions.

5. (Current at +105°C - Current at -45°C) / (+150°C)

6. (Current at +5.25 V - Current at +4.75 V) / (+5.25 V - +4.75 V)





TYPICAL PERFORMANCE GRAPHS

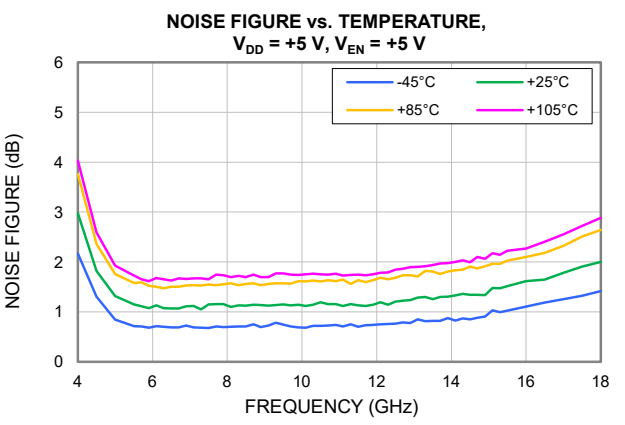
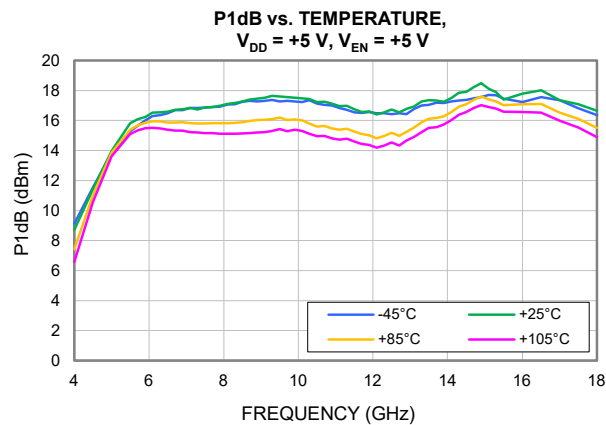
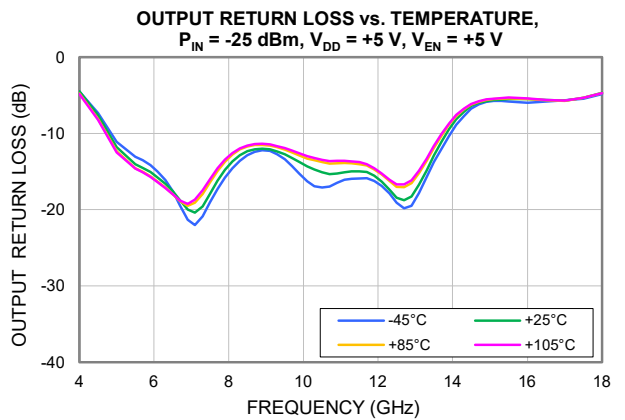
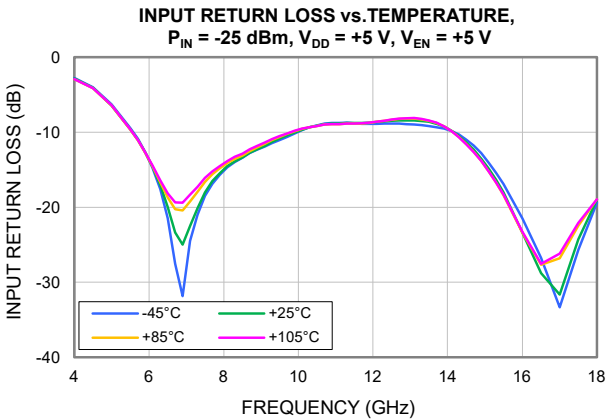
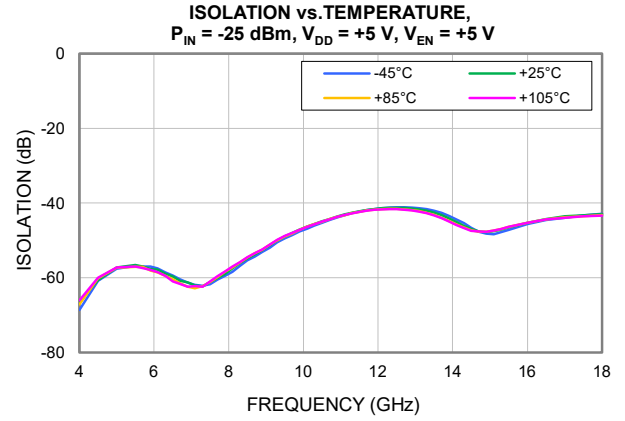
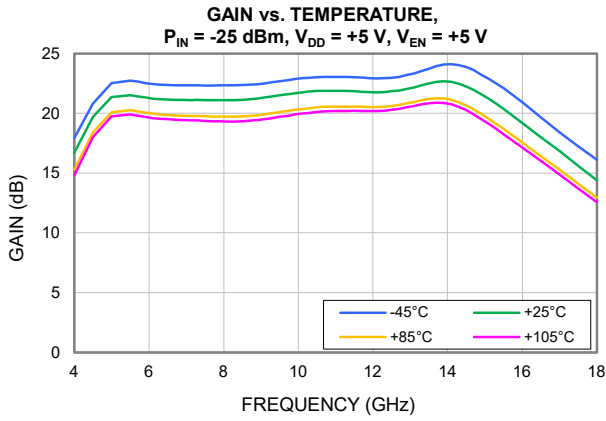



TYPICAL PERFORMANCE GRAPHS

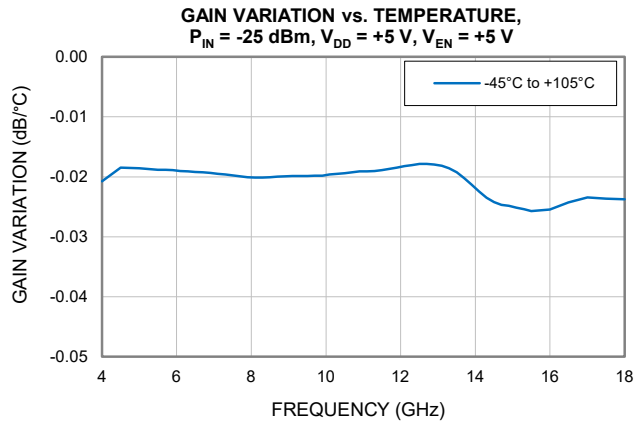
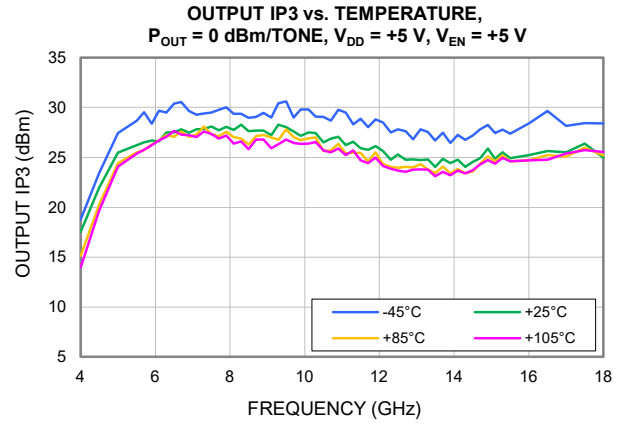
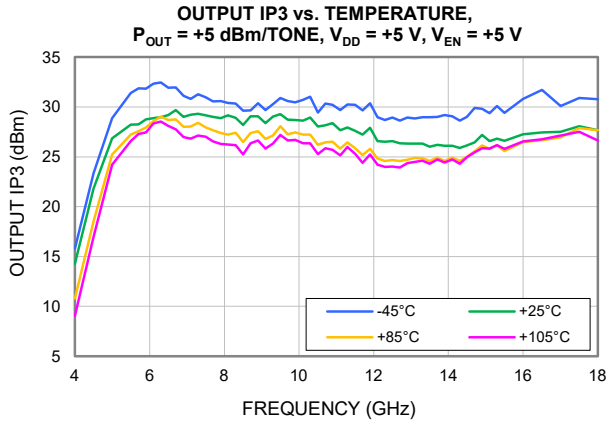



TYPICAL PERFORMANCE GRAPHS

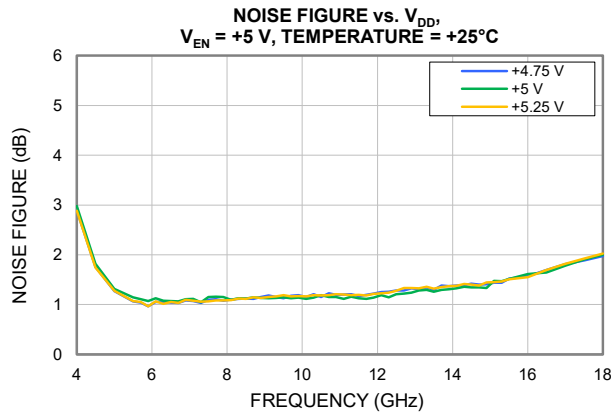
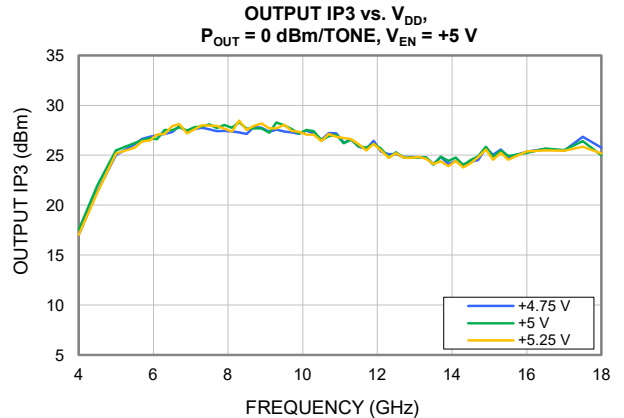
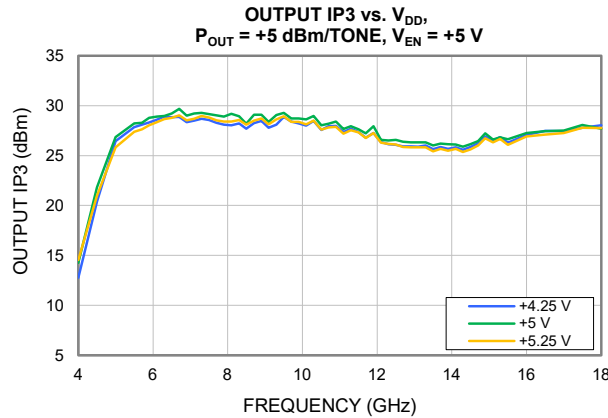
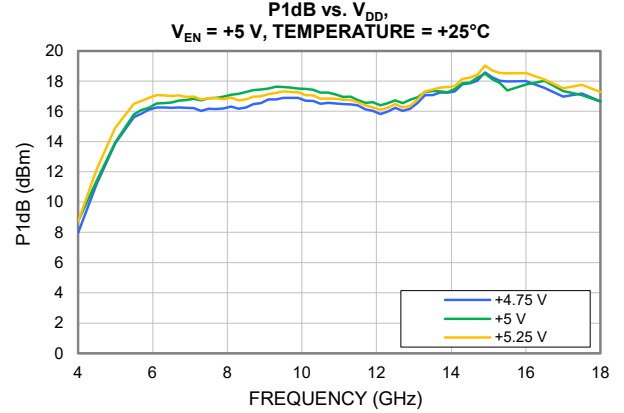
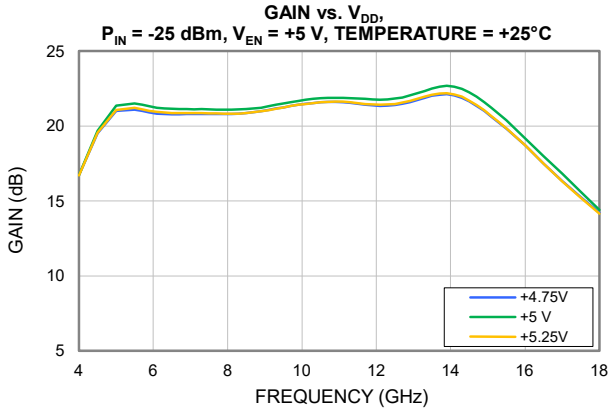



MMIC SURFACE MOUNT

Low Noise Amplifier

PMA3-5153+

50Ω 5.5 to 15.5 GHz Shutdown Feature

ABSOLUTE MAXIMUM RATINGS⁷

Parameter	Ratings
Operating Temperature	-45°C to +105°C
Storage Temperature	-65°C to +150°C
Junction Temperature ⁸	+150°C
Total Power Dissipation	0.7 W
Input Power (CW), V _{DD} = +5 V	+25 dBm
DC Voltage at V _{DD}	+7 V
DC Current I _{DD}	100 mA
DC Voltage at V _{EN}	+7 V

7. Permanent damage may occur if any of these limits are exceeded. Maximum ratings are not intended for continuous normal operation.

8. Peak temperature on top of Die.

ENABLE VOLTAGE (V_{EN})

	Min.	Typ.	Max.	Units
Amplifier-ON	+4.75	+5.0	+5.25	V
Amplifier-OFF	0	-	+1.5	V

THERMAL RESISTANCE

Parameter	Ratings
Thermal Resistance (Θ _{JC}) ⁹	57.1°C/W

9. Θ_{JC} = (Hot Spot Temperature on Die - Temperature at Ground Lead)/Dissipated Power

ESD RATING

	Class	Voltage Range	Reference Standard
HBM	1C	1000 V to < 2000 V	ANSI/ESDA/JEDEC JS-001-2017



ESD HANDLING PRECAUTION: This device is designed to be Class 1C for HBM. Static charges may easily produce potentials higher than this with improper handling and can discharge into DUT and damage it. As a preventive measure Industry standard ESD handling precautions should be used at all times to protect the device from ESD damage.

MSL RATING

Moisture Sensitivity: MSL1 in accordance with IPC/JEDEC J-STD-020E/JEDEC J-STD-033C





MMIC SURFACE MOUNT

Low Noise Amplifier

PMA3-5153+

Mini-Circuits

50Ω 5.5 to 15.5 GHz Shutdown Feature

FUNCTIONAL DIAGRAM

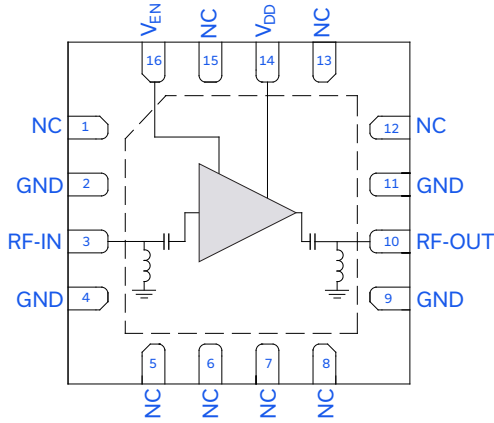

Figure 1. PMA3-5153+ Functional Diagram

PAD DESCRIPTION

Function	Pad Number	Description (Refer to Fig 2)
RF-IN	3	RF-IN Pad connects to RF Input port.
RF-OUT	10	RF-OUT Pad connects to RF Output port.
V _{DD}	14	DC Input Pad connects to voltage input port V _{DD} .
V _{EN}	16	DC Input Pad connects to voltage input port V _{EN} .
GND	2, 4, 9, 11 & Paddle	Connects to ground.
NC	1, 5-8, 12, 13, 15	Not used internally. Connected to ground on test board.

CHARACTERIZATION TEST BOARD

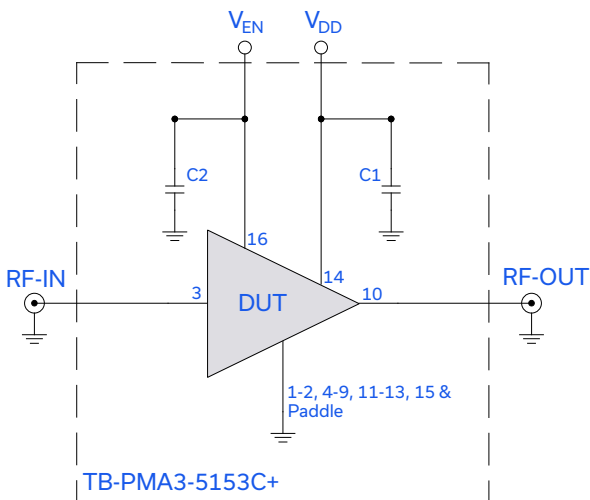

Figure 2. PMA3-5153+ Characterization and Application Circuit.

Electrical Parameters and Conditions

Gain, Return Loss, Output Power at 1dB Compression (P1dB), Output IP3 (OIP3), and Noise Figure measured using N5242A PNA-X microwave network analyzer. For Switching Speed measurements, bypass capacitor C2 was removed from TB-PMA3-5153C+.

Conditions:

- Gain and Return Loss: P_{IN} = -25 dBm
- Output IP3 (OIP3): Two tones, spaced 1 MHz apart, 0 dBm/Tone & +5 dBm/Tone at output.
- V_{DD} = +5 V

Component	Value	Size	Part Number	Manufacturer
C1, C2	1 μF	0402	GRM155C81E105KE11D	Murata

Power ON/Power OFF Sequence:

PMA3-5153+ is not sensitive to power ON/OFF sequence. V_{DD} and V_{EN} can be applied in any order.



MMIC SURFACE MOUNT

Low Noise Amplifier

PMA3-5153+

Mini-Circuits

50Ω 5.5 to 15.5 GHz Shutdown Feature

CASE STYLE DRAWING

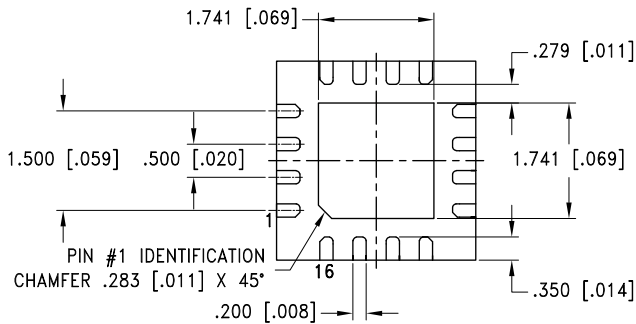
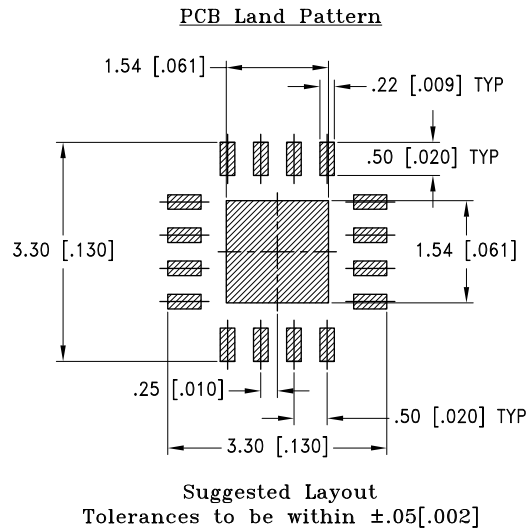
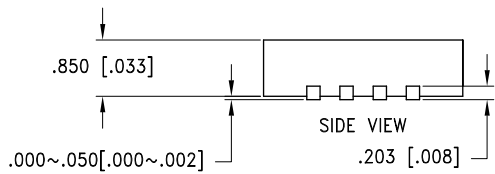
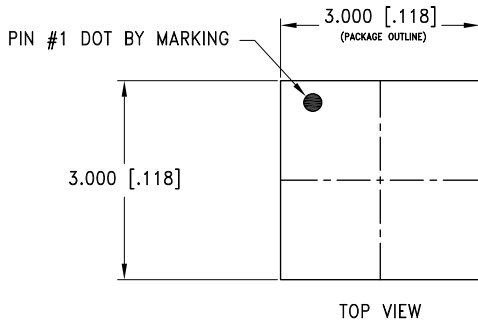

Weight: .02 grams
Dimensions are in mm [Inches]. Tolerances: 3 Pl. ±.05 [.002]

PRODUCT MARKING

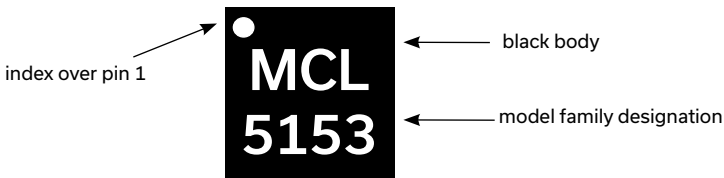

Marking may contain other features or characters for internal lot control



MMIC SURFACE MOUNT

Low Noise Amplifier

PMA3-5153+

50Ω 5.5 to 15.5 GHz Shutdown Feature

ADDITIONAL DETAILED INFORMATION IS AVAILABLE ON OUR DASHBOARD

[CLICK HERE](#)

Performance Data & Graphs	Data Graphs S-Parameter (S2P Files) Data Set (.zip file)
Case Style	DQ3005 Plastic package, exposed paddle, Lead Finish: Matte-Tin
RoHS Status	Compliant
Tape & Reel Standard quantities available on reel	F104 7" reels with 20, 50, 100, 200, 500, 1000, or 2000 devices
Suggested Layout for PCB Design	PL-785
Evaluation Board	TB-PMA3-5153C+ Gerber File
Environmental Ratings	ENV08T1

NOTES

- A. Performance and quality attributes and conditions not expressly stated in this specification document are intended to be excluded and do not form a part of this specification document.
- B. Electrical specifications and performance data contained in this specification document are based on Mini-Circuit's applicable established test performance criteria and measurement instructions.
- C. The parts covered by this specification document are subject to Mini-Circuits standard limited warranty and terms and conditions (collectively, "Standard Terms"); Purchasers of this part are entitled to the rights and benefits contained therein. For a full statement of the standard terms and the exclusive rights and remedies thereunder, please visit Mini-Circuits' website at www.minicircuits.com/terms/viewterm.html

