



LTCC SURFACE MOUNT

# Low Pass Filter

## LFHK-3000+

50Ω

DC to 3000 MHz

### THE BIG DEAL

- Low Insertion Loss, 1.4 dB Typ.
- Passband Return Loss, 13 dB Typ.
- Stopband Rejection, 75 dB Typ.
- 1008 Surface Mount Footprint
- Power Handling: 7.5 W
- Shielded Construction: Prevents De-Tuning & EMI
- Protected by US Patents 11,638,370 and 11,744,057

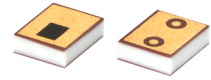

Generic photo used for illustration purposes only

### APPLICATIONS

- Harmonic Rejection and Spurious Cleanup
- Radar, EW, and ECM Defense Systems
- Satellite Communications
- Test and Measurement Equipment
- UHF Transmitters / Receivers

### FUNCTIONAL DIAGRAM

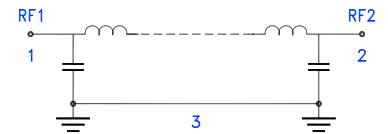

### PRODUCT OVERVIEW

The LFHK-3000+ is a passive RF component designed for signal conditioning in low-frequency circuits. It utilizes ceramic-based construction to achieve stable electrical behavior across a broad operating range. The device supports bidirectional signal flow and is optimized for integration into compact layouts, making it suitable for dense PCB designs. Its surface-mount format aligns with standard automated assembly processes, and the internal structure is engineered to minimize parasitic effects that could impact performance at microwave frequencies. The component is built to maintain consistent characteristics under varying environmental conditions, contributing to overall system reliability.

### ELECTRICAL SPECIFICATIONS<sup>1,2,3</sup> AT +25°C

Parameter	F#	Frequency (MHz)	Min.	Typ.	Max.	Units	
Passband	Insertion Loss	DC-F1	DC - 3000	—	1.4	2	dB
	Freq. Cut-Off <sup>4</sup>	Fc	3450	—	3	—	
	Return Loss	DC-F1	DC - 3000	—	13	—	
Stopband	Rejection	F2-F3	4250 - 6300	20	30	—	dB
		F3-F4	6300 - 11000	62	75	—	
		F4-F5	11000 - 21000	—	63	—	
		F5-F6	21000 - 40000	—	38	—	
		F6-F7	40000 - 50000	—	40	—	

1. Tested in Evaluation Board P/N TB-LFHK-3000+.
2. This filter is bi-directional RF1 and RF2 ports may be interchanged, see S-Parameters for actual performance.
3. This component should not be used as a DC-block. In applications where DC voltage and/or current is present at either the input or output ports, external DC blocking capacitors are required.
4. Typical variation ± 5%.

### ABSOLUTE MAXIMUM RATINGS<sup>5</sup>

Operating Temperature	-55°C to +125°C
Storage Temperature	-55°C to +125°C
Input Power <sup>6</sup>	7.5 W @ +25°C

5. Permanent damage may occur if any of these limits are exceeded.
6. Power rating applies only to signals within the passband. Power rating above +25°C operating temperature decreases linearly to 1.3 W at +125°C.

### TYPICAL FREQUENCY RESPONSE

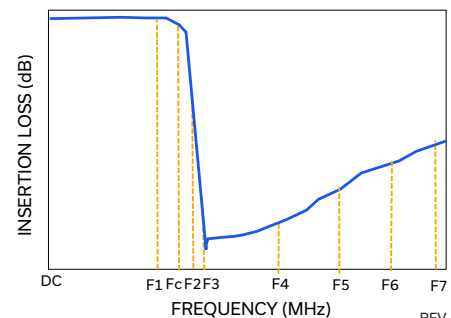



### TYPICAL PERFORMANCE GRAPHS

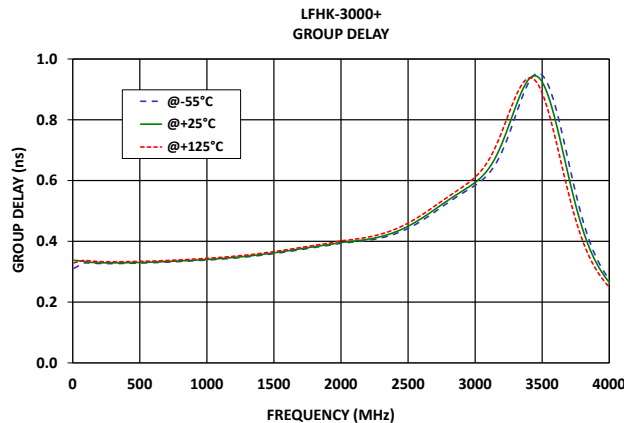
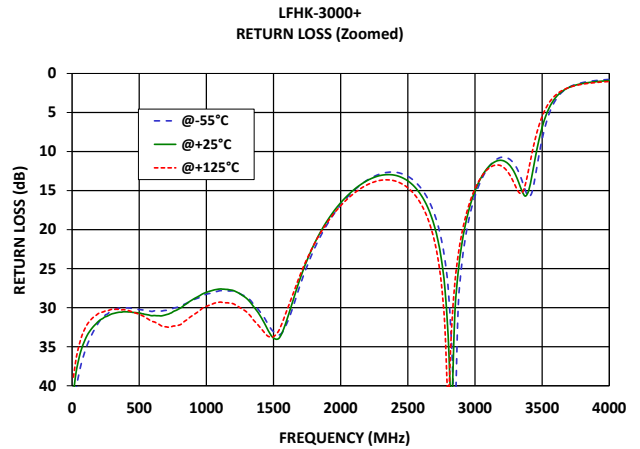
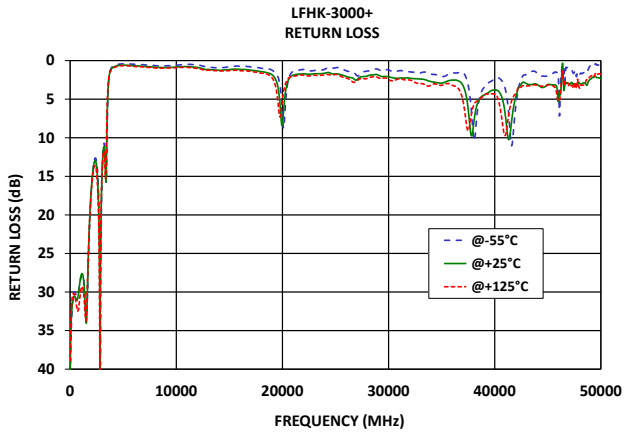
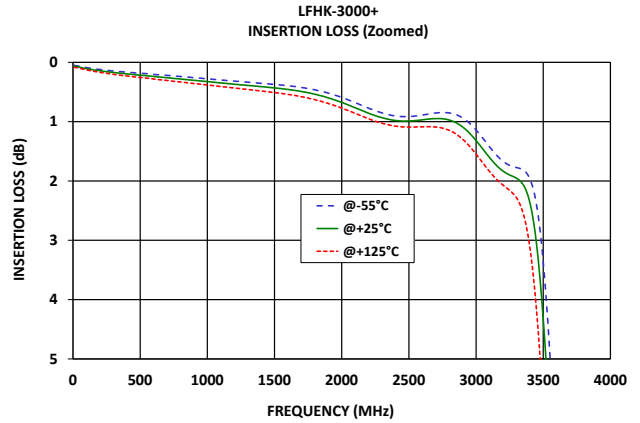
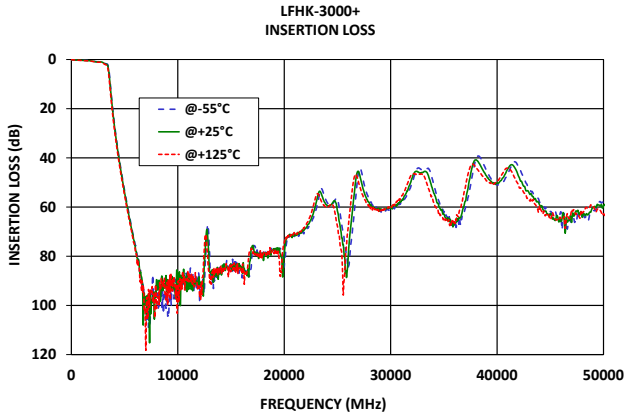



### FUNCTIONAL DIAGRAM

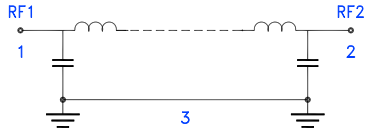
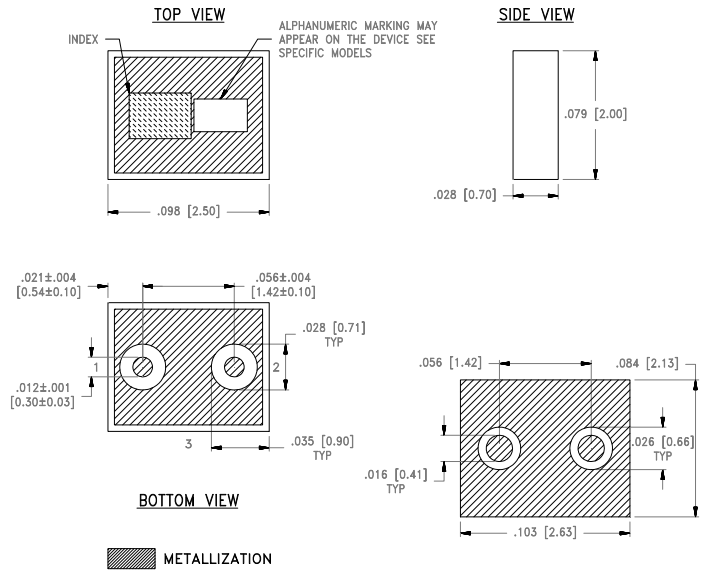

Figure 1. LFHK-3000+ Functional Diagram

### PAD DESCRIPTION

Function	Pad Number	Description
RF1 <sup>2</sup>	1	Connects to RF Input Port
RF2 <sup>2</sup>	2	Connects to RF Output Port
GROUND	3	Connects to Ground on PCB, (See drawing PL-798)

### CASE STYLE DRAWING



Weight: .019 grams.

Dimensions are in inches (mm). Tolerances: 2Pl. ± .01; 3Pl. ± .005

### PRODUCT MARKING\*: W9

\*Marking may contain other features or characters for internal lot control.



### SUGGESTED PCB LAYOUT

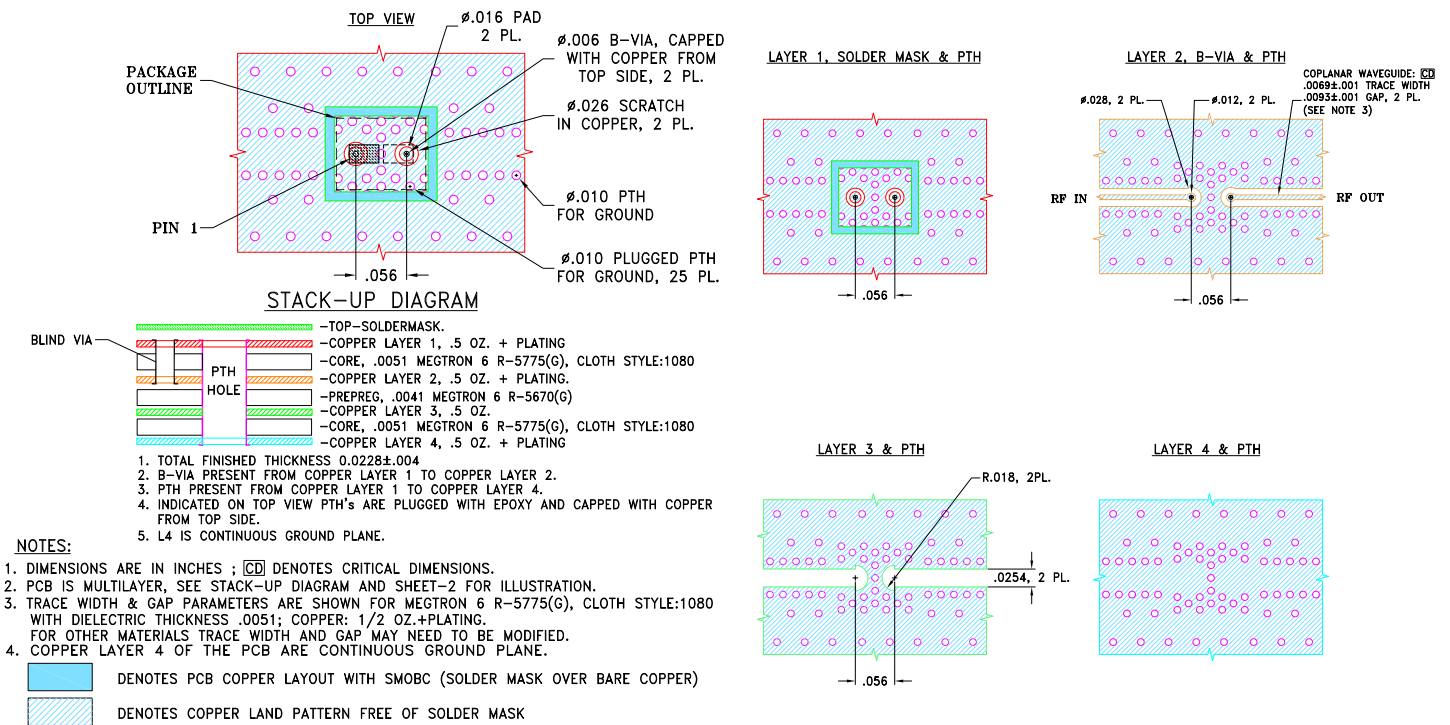

Figure 2. Suggested PCB Layout



LTCC SURFACE MOUNT

# Low Pass Filter

## LFHK-3000+

50Ω

DC to 3000 MHz

ADDITIONAL DETAILED INFORMATION IS AVAILABLE ON OUR DASHBOARD

[CLICK HERE](#)

Performance Data & Graphs	Data Graphs S-Parameter (S2P Files) Data Set (.zip file) De-embedded to device pads
Case Style	NL1008C-9    Lead Finish: Gold over Electroless Nickel
RoHS/REACH Status	Compliant
Tape and Reel	F75
Suggested Layout for PCB Design	PL-798
Evaluation Board	TB-LFHK-3000+ Gerber File
Environmental Rating	ENV06T10

NOTES

- A. Performance and quality attributes and conditions not expressly stated in this specification document are intended to be excluded and do not form a part of this specification document.
- B. Electrical specifications and performance data contained in this specification document are based on Mini-Circuits' applicable established test performance criteria and measurement instructions.
- C. The parts covered by this specification document are subject to Mini-Circuits' standard limited warranty and terms and conditions (collectively, "Standard Terms"); Purchasers of this part are entitled to the rights and benefits contained therein. For a full statement of the standard terms and the exclusive rights and remedies thereunder, please visit Mini-Circuits' website at [www.minicircuits.com/terms/viewterm.html](http://www.minicircuits.com/terms/viewterm.html)

