



LTCC SURFACE MOUNT

Low Pass Filter

LFHK-2250+

50Ω

DC to 2250 MHz

THE BIG DEAL

- Low Insertion Loss, 1.5 dB Typ.
- Passband Return Loss, 18 dB Typ.
- Stopband Rejection, 72 dB Typ.
- 1008 Surface Mount Footprint
- Power Handling: 7.5 W

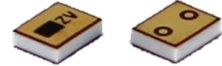

Generic photo used for illustration purposes only

APPLICATIONS

- Test and Measurement Equipment
- Harmonic Rejection
- VHF/UHF Transmitters / Receivers
- Lab use

FUNCTIONAL DIAGRAM

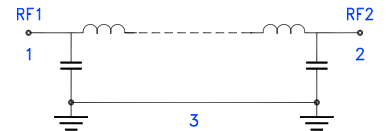

PRODUCT OVERVIEW

Mini-Circuits' LFHK-2250+ is a miniature low temperature co-fired ceramic (LTCC) low pass filter with a DC to 2250 MHz passband supporting a variety of applications. This model provides 1.5 dB typical insertion loss over a wide band due to its rugged monolithic construction. Housed in a small 1008 ceramic form factor the filter is ideal for dense signal chain PCB layouts where it complements MMIC size and performance. The LTCC fabrication process assures minimal RF performance variation while delivering a product that is well suited for environmental extremes of high humidity and temperature.

KEY FEATURES

Features	Advantages
Ultra-Wide Stopband	The LTCC lowpass filter provides a very good stopband rejection up to 43 GHz, suitable for wide band applications.
LTCC Construction	Provides repeatable performance in a rugged, ceramic package well suited for tough environments such as high humidity and temperature extremes.
Small Size, 1008	Saves space in dense circuit board layouts and minimizes the effects of parasitics.
Rugged Power Handling, 7.5 Watts	Handles up to 7.5 Watts in a small 1008 package.



ELECTRICAL SPECIFICATIONS^{1,2,3} AT +25°C

Parameter	F#	Frequency (MHz)	Min.	Typ.	Max.	Units	
Passband	Insertion Loss	DC-F1	DC - 2250	—	1.5	2.3	dB
	Freq. Cut-Off ⁴	Fc	2530	—	3	—	dB
	Return Loss	DC-F1	DC - 2250	10	18	—	dB
Stopband	Rejection	F2-F3	3100 - 4800	20	34	—	dB
		F3-F4	4800 - 11000	65	72	—	
		F4-F5	11000 - 18000	50	68	—	
		F5-F6	18000 - 35000	38	45	—	
		F6-F7	35000 - 43000	27	46	—	

1. Tested on Evaluation Board P/N TB-LFHK-2250+ with connectors and feedline de-embedded with thru-line compensation.
2. This filter is bi-directional, RF1 and RF2 ports may be interchanged.
3. In applications where DC voltage and/or current is present at either the input or output ports, external DC blocking capacitors are required.
4. Typical variation ±5%.

ABSOLUTE MAXIMUM RATINGS⁵

Parameter	Ratings
Operating Temperature	-55°C to +125°C
Storage Temperature	-55°C to +125°C
Input Power ⁶	7.5 W @25°C

5. Permanent damage may occur if any of these limits are exceeded.
6. Power rating applies only to signals within the passband. Power rating above +25°C operating temperature decreases linearly to 1.3 W at +125°C.

TYPICAL FREQUENCY RESPONSE AT +25°C

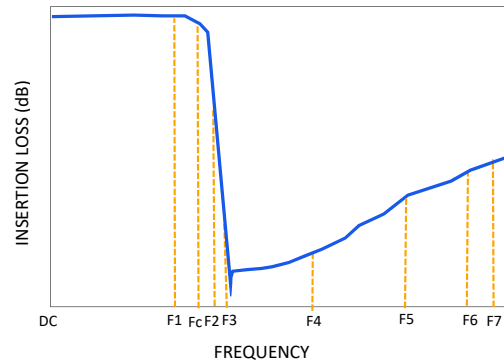



TYPICAL PERFORMANCE GRAPHS

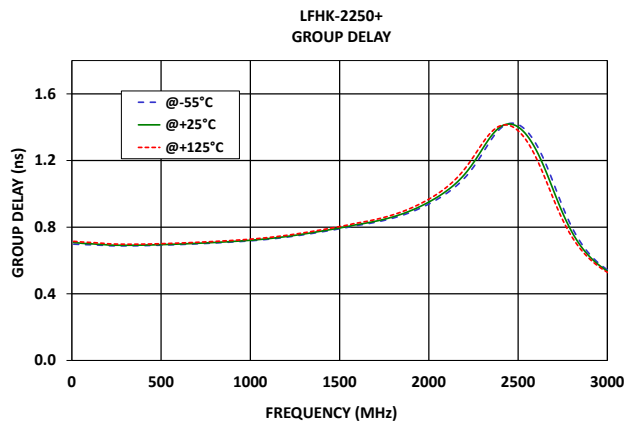
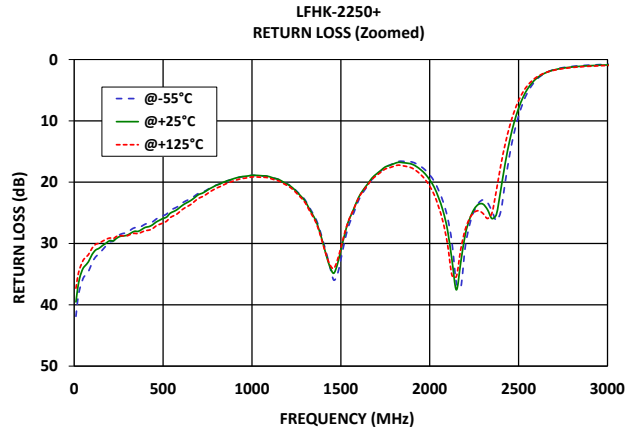
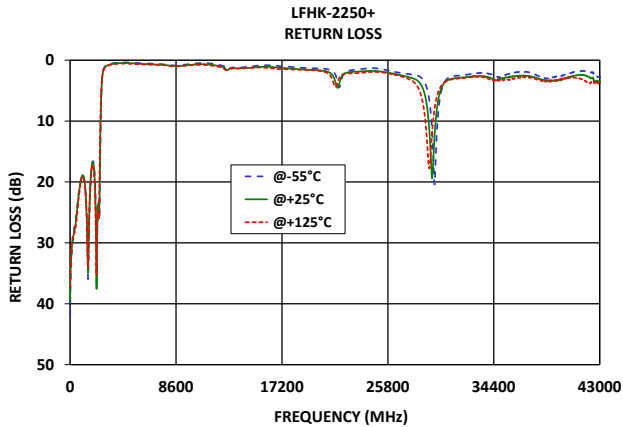
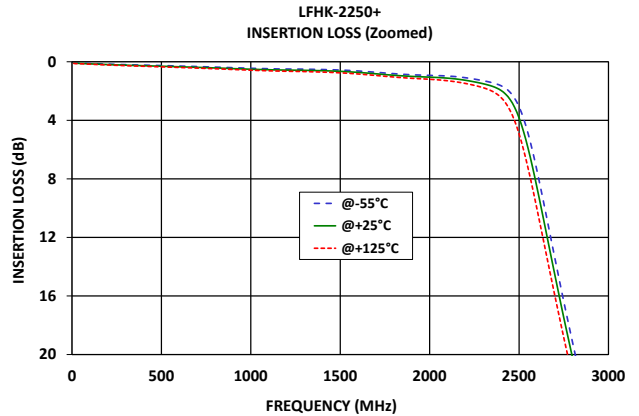
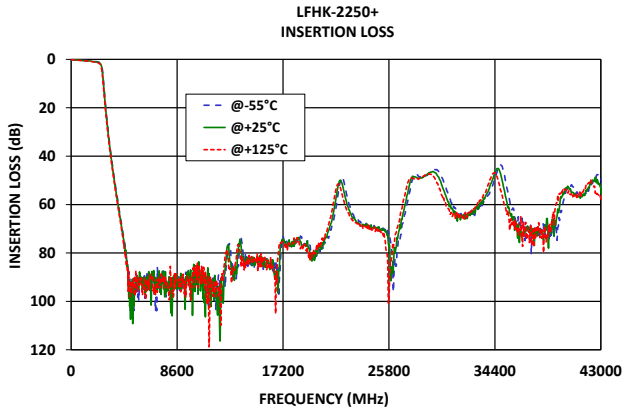



FUNCTIONAL DIAGRAM

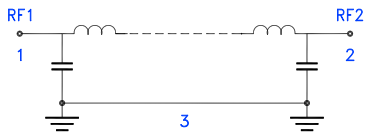
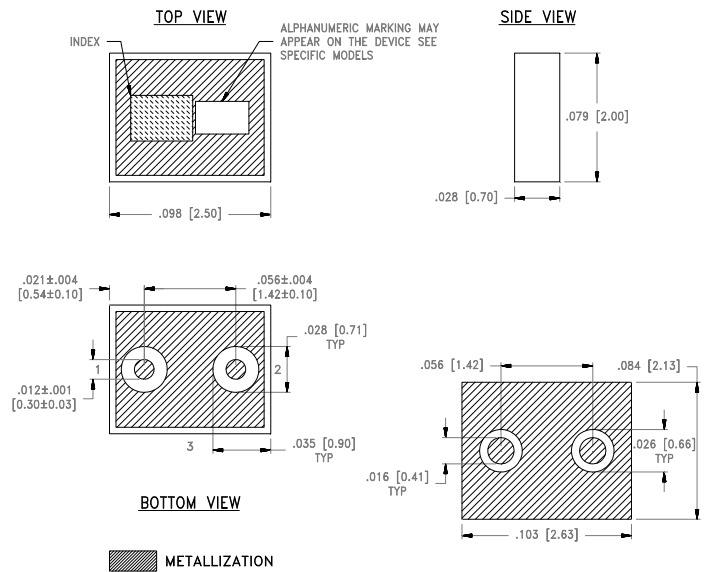

Figure 1. LFHK-2250+ Functional Diagram

PAD DESCRIPTION

Function	Pad Number	Description
RF1 ²	1	Connects to RF Input Port
RF2 ²	2	Connects to RF Output Port
GROUND	3	Connects to Ground on PCB, (See drawing PL-798)
NC	-	No connection, not used internally. See drawing PL-798 for connection to PCB

CASE STYLE DRAWING



Weight: .019 grams.

Dimensions are in inches (mm). Tolerances: 2Pl. ± .01; 3Pl. ± .005

PRODUCT MARKING*: ZV

*Marking may contain other features or characters for internal lot control.



SUGGESTED PCB LAYOUT (PL-798)

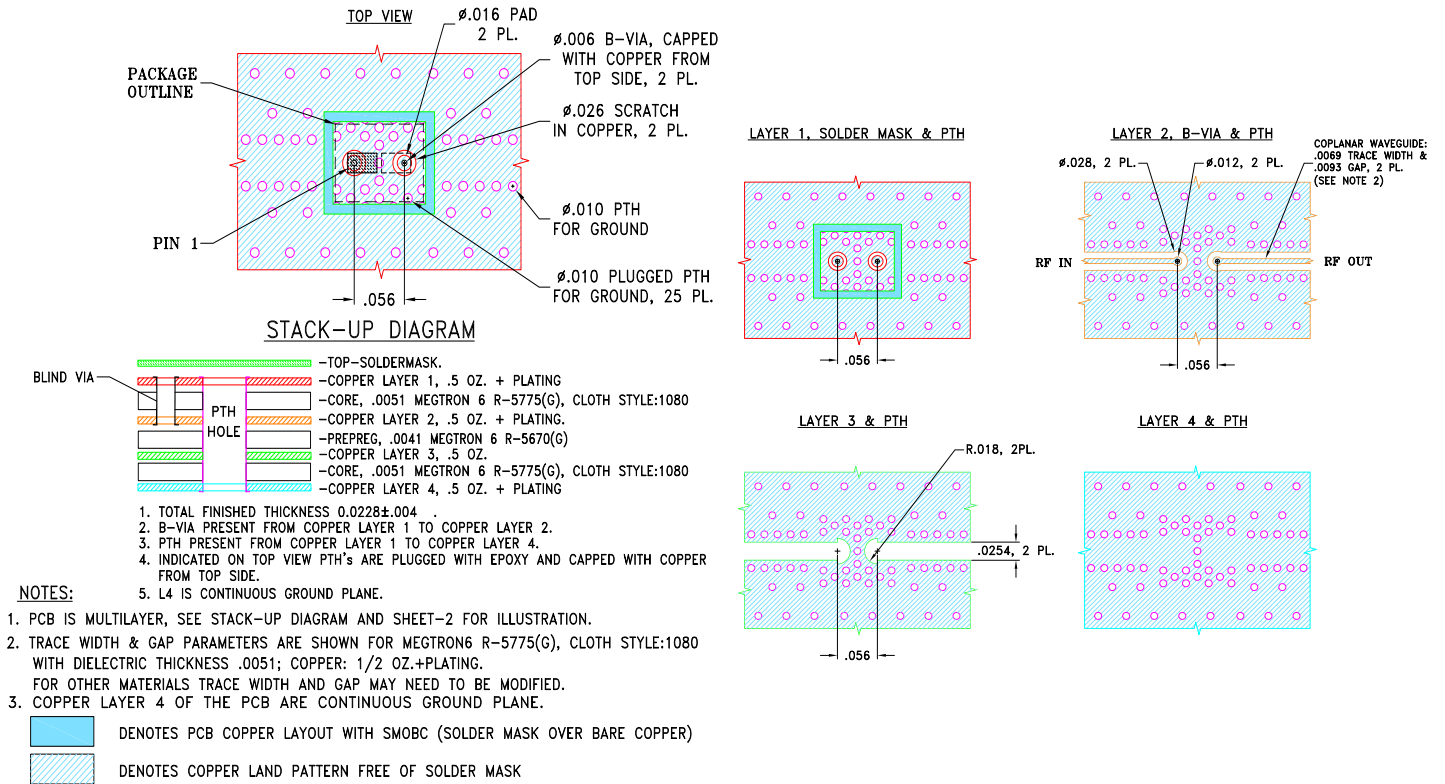

Figure 2. Suggested PCB Layout PL-798

NOTES

A. Performance and quality attributes and conditions not expressly stated in this specification document are intended to be excluded and do not form a part of this specification document.

B. Electrical specifications and performance data contained in this specification document are based on Mini-Circuits' applicable established test performance criteria and measurement instructions.

C. The parts covered by this specification document are subject to Mini-Circuits' standard limited warranty and terms and conditions (collectively, "Standard Terms"); Purchasers of this part are entitled to the rights and benefits contained therein. For a full statement of the standard terms and the exclusive rights and remedies thereunder, please visit Mini-Circuits' website at www.minicircuits.com/terms/viewterm.html



LTCC SURFACE MOUNT

Low Pass Filter

LFHK-2250+

50Ω

DC to 2250 MHz

ADDITIONAL DETAILED INFORMATION IS AVAILABLE ON OUR DASHBOARD.

[CLICK HERE](#)

Performance Data and Graphs	Data Graphs S-Parameter (S2P Files) Data Set (.zip file) De-embedded to device pads
Case Style	NL1008C-9 Lead Finish: Gold over Electroless Nickel
RoHS Status	Compliant
Tape and Reel	TR-F75
Suggested Layout for PCB Design	PL-798
Evaluation Board	TB-LFHK-2250+
	Gerber File
Environmental Rating	ENV06T10

NOTES

- A. Performance and quality attributes and conditions not expressly stated in this specification document are intended to be excluded and do not form a part of this specification document.
- B. Electrical specifications and performance data contained in this specification document are based on Mini-Circuits' applicable established test performance criteria and measurement instructions.
- C. The parts covered by this specification document are subject to Mini-Circuits' standard limited warranty and terms and conditions (collectively, "Standard Terms"); Purchasers of this part are entitled to the rights and benefits contained therein. For a full statement of the standard terms and the exclusive rights and remedies thereunder, please visit Mini-Circuits' website at www.minicircuits.com/terms/viewterm.html

