

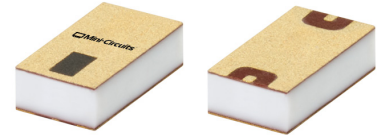

### THE BIG DEAL

- Low Insertion Loss, Typ. 2.9 dB
- Stopband Rejection, Typ. 37 dB
- Passband Return Loss, Typ. 11 dB
- Rugged Ceramic Construction
- 1206 Surface Mount Footprint



Generic photo used for illustration purposes only

### FUNCTIONAL DIAGRAM

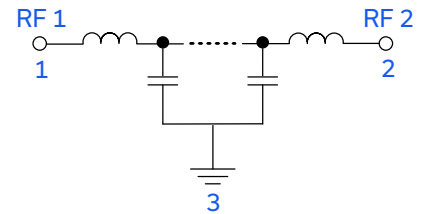

### APPLICATIONS

- Communications
- Radar, EW, and ECM Defense Systems
- Test & Measurement Equipment

### PRODUCT OVERVIEW

Mini-Circuits' LFCN-3602+ is a miniature low-temperature co-fired ceramic (LTCC) low pass filter with a DC to 36 GHz passband that supports a variety of applications. This model provides 2.9 dB typical insertion loss over a wide band, due to its rugged monolithic construction. Housed in a small 1206 ceramic form factor, the filter is ideal for dense signal chain PCB layouts, where it complements MMIC size and performance. The LTCC fabrication process assures minimal RF performance variation while delivering a product that is well-suited for environmental extremes of high humidity and temperature.

### KEY FEATURES

Feature	Advantages
Ultra-Wide Stopband	Provides excellent stopband rejection to 67 GHz, suitable for wideband applications.
LTCC Construction	The use of LTCC technology allows for repeatable performance in a rugged ceramic package, well suited for tough environments such as high humidity and temperature extremes. See Mini-Circuits Environmental Rating ENV06T10 for more information.
Excellent Performance for Size	Offers best in class performance relative to larger-size alternative technologies. This mmWave multi-layer surface mount LTCC filter in a 1206 package allows for space to be saved in dense circuit board layouts, while also minimizing the effects of parasitics.



### ELECTRICAL SPECIFICATIONS<sup>1,2,3</sup> AT +25°C

Parameter	F#	Frequency (GHz)	Min.	Typ.	Max.	Units
Passband	Insertion Loss	DC - F1	—	2.9	3.6	dB
	Freq. Cut-Off <sup>4</sup>	Fc	—	3	—	dB
	Return Loss	DC - F1	—	11	—	dB
Stopband	Rejection	F2 - F3	21	31	—	dB
		F3 - F4	27	37	—	

1. Tested on Evaluation Board P/N TB-LFCN-3602C+ with the connector and feedline effects de-embedded using the 2XThru IEEE P370 method.
2. Bi-directional, RF1 and RF2 ports can be interchanged.
3. In applications where DC voltage and/or current is present at either the input or output ports, external DC blocking capacitors are required.
4. Cut-off frequency has typical variation of ±4%.

### ABSOLUTE MAXIMUM RATINGS<sup>5</sup>

Parameter	Ratings
Operating Temperature	-55°C to +125°C
Storage Temperature	-55°C to +125°C
Input Power <sup>6</sup>	1 W

5. Permanent damage may occur if any of these limits are exceeded.
6. Power rating applies only to signals within the passband. Power rating above +25°C operating temperature decreases linearly to 0.5 W at +125°C.

### TYPICAL FREQUENCY RESPONSE AT +25°C

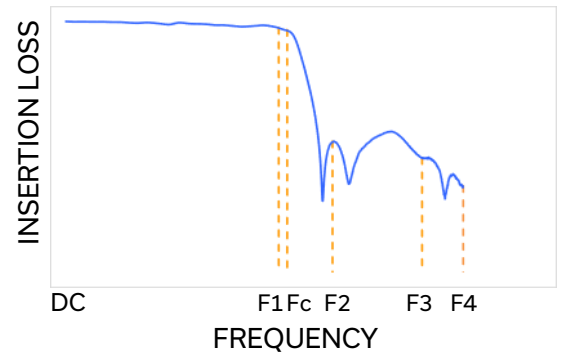



LTCC SURFACE MOUNT

# Low Pass Filter

## LFCN-3602+

Mini-Circuits

50Ω DC to 36 GHz

### TYPICAL PERFORMANCE GRAPHS

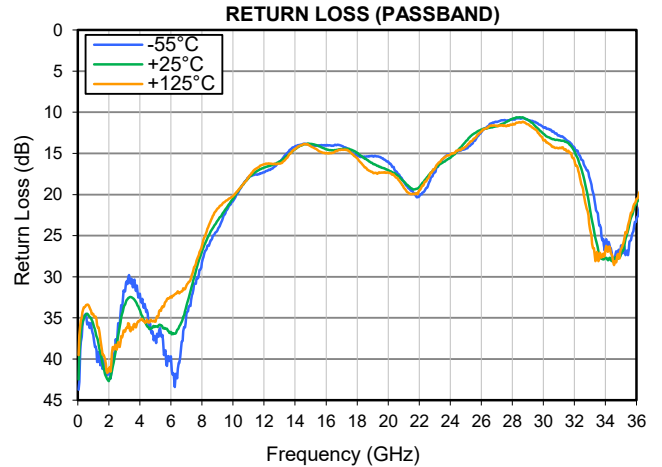
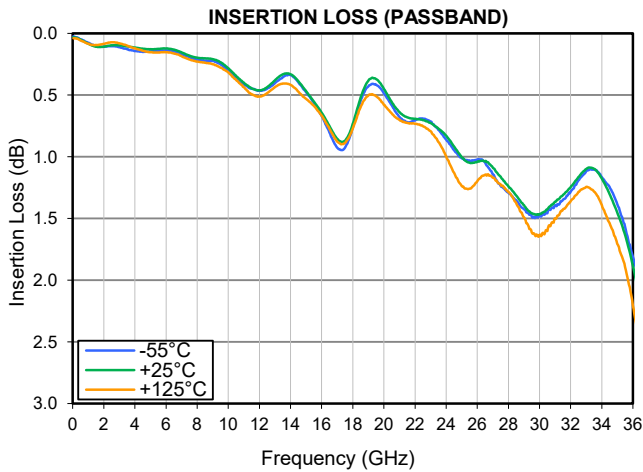
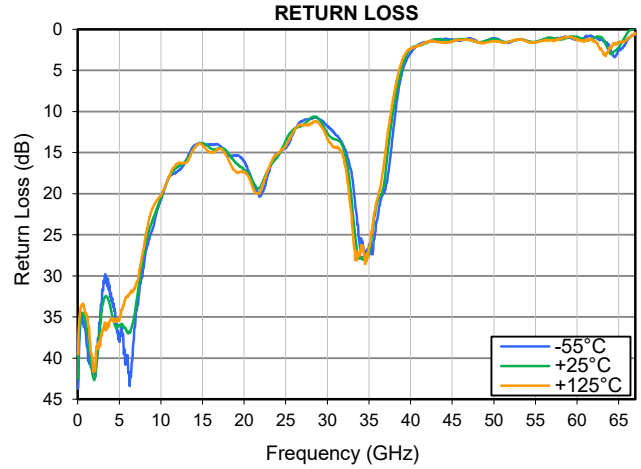
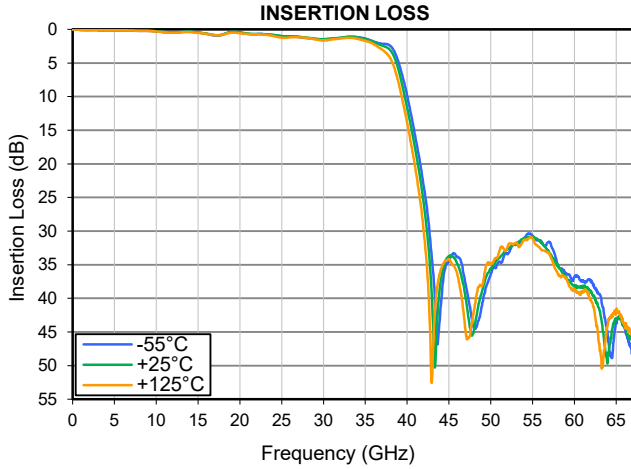



### FUNCTIONAL DIAGRAM

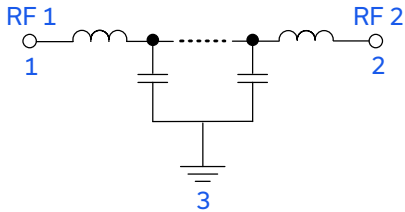
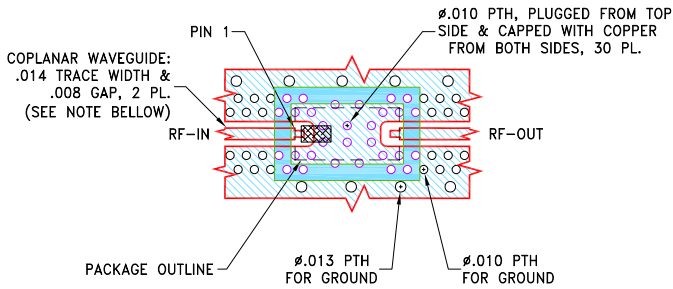

Figure 1. LFCN-3602+ Functional Diagram

### PAD DESCRIPTION

Function	Pad Number	Description
RF1 <sup>2</sup>	1	Connects to RF Input Port
RF2 <sup>2</sup>	2	Connects to RF Output Port
GROUND	3	Connects to Ground on PCB, (See drawing PL-748)

### SUGGESTED PCB LAYOUT (PL-748)



**NOTES:**

- TRACE WIDTH & GAP PARAMETERS ARE SHOWN FOR MEGTRON-7 R5785(N); DIELECTRIC THICKNESS: .0079±.001; COPPER: HVLP/HVLP. FOR OTHER MATERIALS TRACE WIDTH & GAP MAY NEED TO BE MODIFIED.
- BOTTOM SIDE OF THE PCB IS CONTINUOUS GROUND PLANE.

- DENOTES PCB COPPER LAYOUT WITH SMOBC (SOLDER MASK OVER BARE COPPER).
- DENOTES COPPER LAND PATTERN FREE OF SOLDER MASK.

Figure 2. Suggested PCB Layout PL-748

### CASE STYLE DRAWING

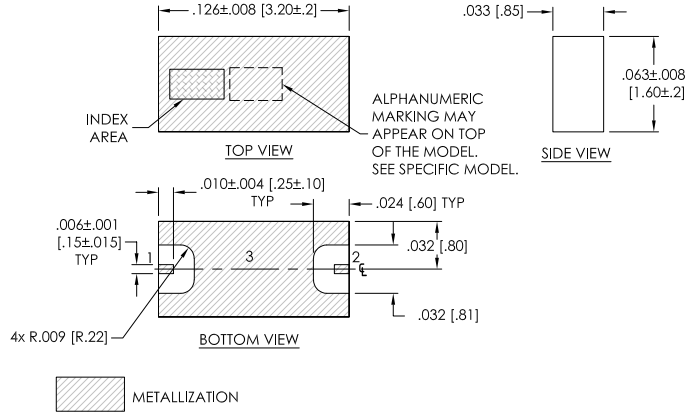

Weight: .017 grams  
Dimensions are in inches [mm]. Tolerances: 2 Pl.±.03; 3Pl.±.015

### PRODUCT MARKING\*: ZD

\*Marking may contain other features or characters for internal lot control.



LTCC SURFACE MOUNT

# Low Pass Filter

## LFCN-3602+

50Ω DC to 36 GHz

ADDITIONAL INFORMATION IS AVAILABLE ON OUR DASHBOARD

[CLICK HERE](#)

<b>Performance Data &amp; Graphs</b>	Data Graphs S-Parameter (S2P Files) Data Set (.zip file) De-embedded to device pads
<b>Case Style</b>	FV1206-12      Lead Finish: Gold over Nickel Plating
<b>RoHS Status</b>	Compliant
<b>Tape and Reel</b>	F75
<b>Suggested Layout for PCB Design</b>	PL-748
<b>Evaluation Board</b>	TB-LFCN-3602C+ Gerber File
<b>Environmental Rating</b>	ENV06T10

- NOTES**
- A. Performance and quality attributes and conditions not expressly stated in this specification document are intended to be excluded and do not form a part of this specification document.
  - B. Electrical specifications and performance data contained in this specification document are based on Mini-Circuit's applicable established test performance criteria and measurement instructions.
  - C. The parts covered by this specification document are subject to Mini-Circuits standard limited warranty and terms and conditions (collectively, "Standard Terms"); Purchasers of this part are entitled to the rights and benefits contained therein. For a full statement of the standard terms and the exclusive rights and remedies thereunder, please visit Mini-Circuits' website at [www.minicircuits.com/terms/viewterm.html](http://www.minicircuits.com/terms/viewterm.html)

