



LTCC SURFACE MOUNT

# High Pass Filter

## HFHK-2700+

50Ω

3000 to 11000 MHz

### THE BIG DEAL

- Insertion Loss, Typ. 0.8 dB
- Stopband Rejection, Typ. 74 dB
- Passband Return Loss, Typ. 17 dB
- 1008 Surface Mount Footprint
- Power Handling: 6 W
- Shielded Construction: Prevents De-Tuning & EMI
- Protected by US Patents 11,638,370 and 11,744,057

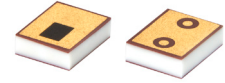

Generic photo used for illustration purposes only

### APPLICATIONS

- 5G Sub- 6 GHz
- Radar, EW, ECM Defense Systems
- Test and Measurement Equipment
- Telecommunications and Broadband Wireless Systems
- WiFi 6E

### FUNCTIONAL DIAGRAM

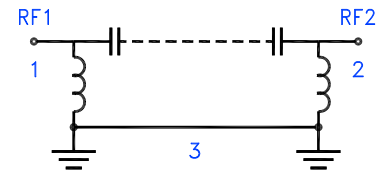

### PRODUCT OVERVIEW

Mini-Circuits' HFHK-2700+ is a miniature low temperature co-fired ceramic (LTCC) high pass filter with a 3000 to 11000 MHz passband that supports a variety of applications. This model provides 0.8 dB typical insertion loss over a wide band due to its rugged monolithic construction. Housed in a small 1008 ceramic form factor, the filter is ideal for dense signal chain PCB layouts where it complements MMIC size and performance. The LTCC fabrication process assures minimal RF performance variation while delivering a product that is well suited for environmental extremes of high humidity and temperature.

### KEY FEATURES

Features	Advantages
Wide Passband, 8 GHz	This filter has a very wide passband from, 3000 to 11000 MHz.
LTCC Construction	Provides repeatable performance in a rugged, ceramic package well suited for tough environments such as high humidity and temperature extremes.
Small Size, 1008	Saves space in dense circuit board layouts and minimizes the effects of parasitics.
Rugged Power Handling, 6 Watts	Handles up to 6 Watts in a small 1008 package.
Shielded Construction	Due to the novel construction, it is immune to EMI/EMC effects with other neighboring components/ devices.



### ELECTRICAL SPECIFICATIONS<sup>1,2,3</sup> AT +25°C

Parameter		F#	Frequency (MHz)	Min.	Typ.	Max.	Units
Passband	Insertion Loss	F4-F5	3000 - 4100	—	1.4	2.4	dB
		F5-F6	4100 - 9500	—	0.8	1.6	
		F6-F7	9500 - 11000	—	0.9	2.6	
	Return Loss	F4-F5	3000 - 4100	—	17	—	dB
		F5-F6	4100 - 9500	10	16	—	
		F6-F7	9500 - 11000	—	16	—	
Stopband	Rejection	DC-F1	DC - 850	67	74	—	dB
		F1-F2	850 - 1400	40	52	—	
		F2-F3	1400 - 1950	20	30	—	
	Freq. Cut-Off <sup>4</sup>	Fc	2700	—	3	—	dB

1. Tested on Evaluation Board P/N TB-HFHK-2700+ with connectors and feedline de-embedded with thru-line compensation.

2. This filter is bi-directional RF1 and RF2 ports may be interchanged. See S-Parameters for actual performance.

3. This component should not be used as a DC-block. In applications where DC voltage and/or current is present at either the input or output ports, external DC blocking capacitors are required.

4. Typical variation ±5%.

### ABSOLUTE MAXIMUM RATINGS<sup>5</sup>

Parameter	Ratings
Operating Temperature	-55°C to +125°C
Storage Temperature	-55°C to +125°C
Input Power <sup>6</sup>	6 W @ +25°C

5. Permanent damage may occur if any of these limits are exceeded.

6. Power rating applies only to signals within the passband. Power rating above +25°C operating temperature decreases linearly to 1 W at +125°C.

### TYPICAL FREQUENCY RESPONSE AT +25°C

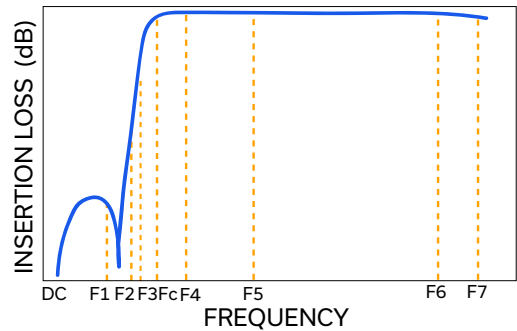



LTCC SURFACE MOUNT

# High Pass Filter

## HFHK-2700+

Mini-Circuits

50Ω

3000 to 11000 MHz

### TYPICAL PERFORMANCE GRAPHS

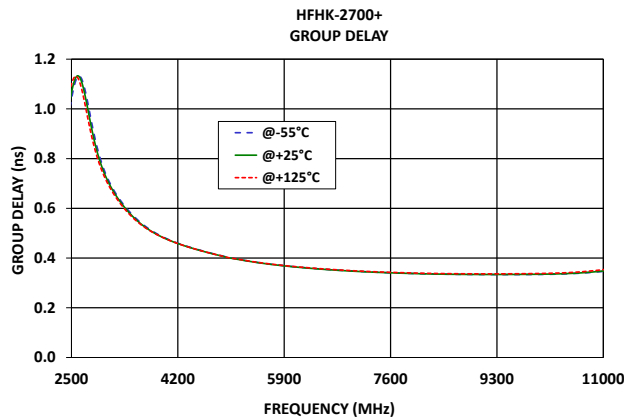
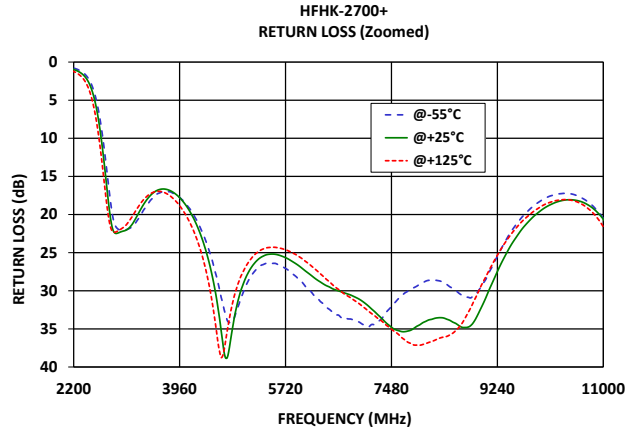
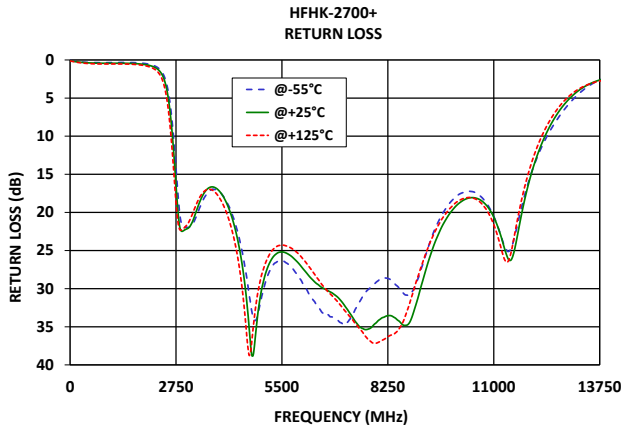
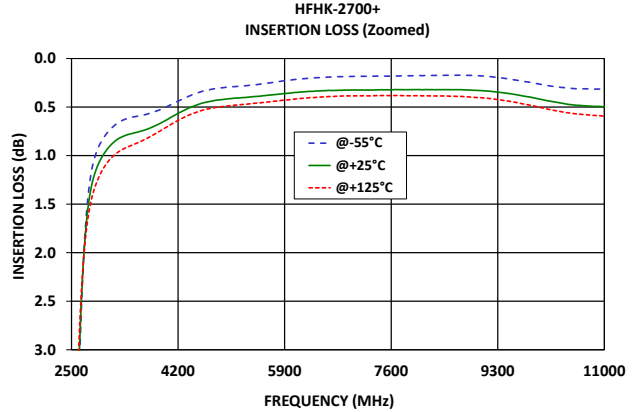
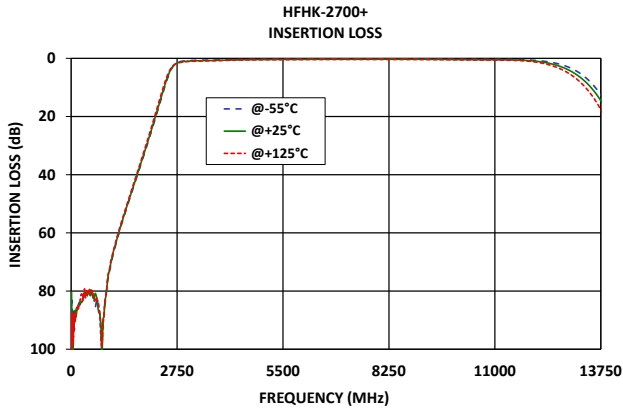



### FUNCTIONAL DIAGRAM

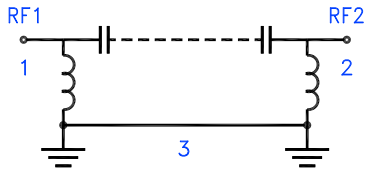
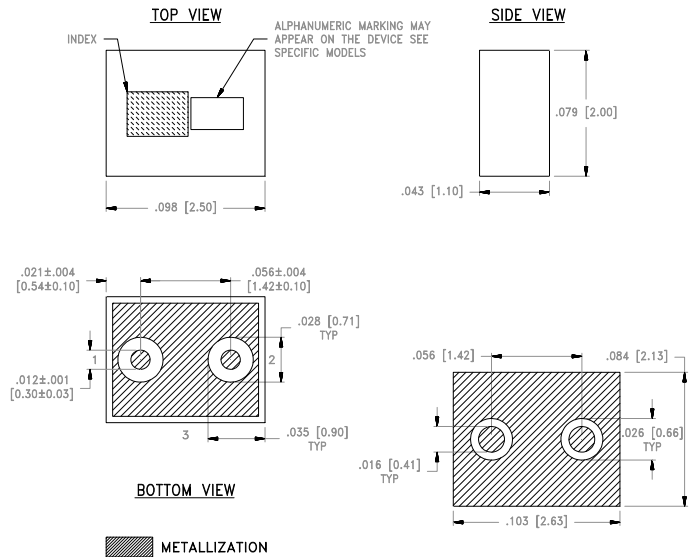

Figure 1. HFHK-2700+ Functional Diagram

### PAD DESCRIPTION

Function	Pad Number	Description
RF1 <sup>2</sup>	1	Connects to RF Input Port
RF2 <sup>2</sup>	2	Connects to RF Output Port
GROUND	3	Connects to Ground on PCB, (See drawing PL-798)
NC	—	No connection, not used internally. See drawing PL-798 for connection to PCB

### CASE STYLE DRAWING



Weight: .019 grams.

Dimensions are in inches (mm). Tolerances: 2Pl. ± .01; 3Pl. ± .005

### PRODUCT MARKING\*: J2

\*Marking may contain other features or characters for internal lot control.



### SUGGESTED PCB LAYOUT (PL-798)

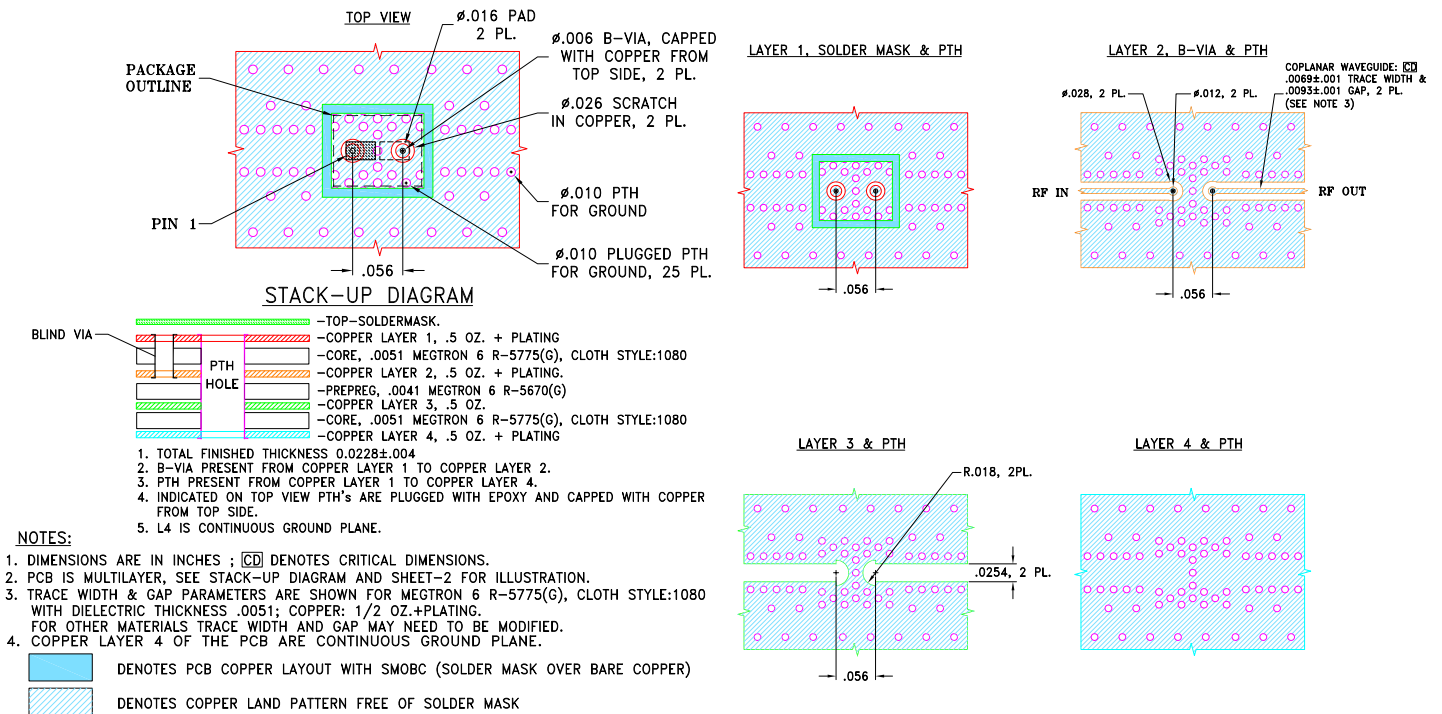

Figure 2. Suggested PCB Layout PL-798



LTCC SURFACE MOUNT

# High Pass Filter

## HFHK-2700+

50Ω

3000 to 11000 MHz

Mini-Circuits

ADDITIONAL DETAILED INFORMATION IS AVAILABLE ON OUR DASHBOARD.

[CLICK HERE](#)

Performance Data and Graphs	Data
	Graphs S-Parameter (S2P Files) Data Set (.zip file) De-embedded to device pads
Case Style	NL1008C-10 Lead Finish: Gold over Electroless Nickel
RoHS Status	Compliant
Tape and Reel	TR-F75
Suggested Layout for PCB Design	PL-798
Evaluation Board	TB-HFHK-2700+
	Gerber File
Environmental Rating	ENV06T10

### NOTES

- A. Performance and quality attributes and conditions not expressly stated in this specification document are intended to be excluded and do not form a part of this specification document.
- B. Electrical specifications and performance data contained in this specification document are based on Mini-Circuits' applicable established test performance criteria and measurement instructions.
- C. The parts covered by this specification document are subject to Mini-Circuits' standard limited warranty and terms and conditions (collectively, "Standard Terms"); Purchasers of this part are entitled to the rights and benefits contained therein. For a full statement of the standard terms and the exclusive rights and remedies thereunder, please visit Mini-Circuits' website at [www.minicircuits.com/terms/viewterm.html](http://www.minicircuits.com/terms/viewterm.html)

