



LTCC SURFACE MOUNT

High Pass Filter

HFCG-440+

50Ω

550 to 6000 MHz

THE BIG DEAL

- Insertion Loss, Typ. 0.5 dB
- Stopband Rejection, Typ. 51 dB
- Passband Return Loss, Typ. 11 dB
- 0805 Surface Mount Footprint
- Power Handling: 4 W



Generic photo used for illustration purposes only

APPLICATIONS

- Test & Measurement Equipment
- Radar, EW, and ECM Defense System
- 5G MIMO and Back Haul Radio
- 5G Sub 6 GHz and WiFi 6E

FUNCTIONAL DIAGRAM

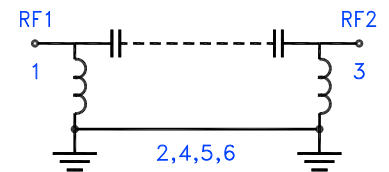

PRODUCT OVERVIEW

Mini-Circuits' HFCG-440+ is a miniature low temperature co-fired ceramic (LTCC) high pass filter with a 550 to 6000 MHz passband that supports a variety of applications. This model provides 0.5 dB typical insertion loss over a wide band due to its rugged monolithic construction. Housed in a small 0805 ceramic form factor the filter is ideal for dense signal chain PCB layouts where it complements MMIC size and performance. The LTCC fabrication process assures minimal RF performance variation while delivering a product that is well suited for environmental extremes of high humidity and temperature.

KEY FEATURES

Features	Advantages
Wide Passband	This filter has a very wide passband, from 550 to 6000 MHz.
LTCC Construction	The use of LTCC technology allows for repeatable performance in a rugged ceramic package, well suited for tough environments such as high humidity and temperature extremes. See Mini-Circuits Environmental Rating ENV06T11 for more information.
Small Size, 0805	Saves space in dense circuit board layouts and minimizes the effects of parasitics.
Rugged Power Handling, 4 W	Handles up to 4 Watts in a small 0805 package.



LTCC SURFACE MOUNT

High Pass Filter

HFCG-440+

Mini-Circuits

50Ω

550 to 6000 MHz

ELECTRICAL SPECIFICATIONS^{1,2,3} AT +25°C

Parameter		F#	Frequency (MHz)	Min.	Typ.	Max.	Units
Passband	Insertion Loss	F3-F4	550 - 1500	—	1.5	2.8	dB
		F4-F5	1500 - 6000	—	0.5	1.4	
	Return Loss	F3-F4	550 - 1500	—	11	—	dB
		F4-F5	1500 - 6000	—	12	—	
Stopband	Rejection	DC-F1	DC - 160	40	51	—	dB
		F1-F2	160 - 300	20	27	—	
	Freq. Cut-Off ⁴	Fc	450	—	3	—	dB

1. Tested on Evaluation Board P/N TB-HFCG-440+ with port extension on option in network analyzer.

2. This filter is bi-directional, RF1 and RF2 ports may be interchanged.

3. This component should not be used as a DC-block. In applications where DC voltage and/or current is present at either the input or output ports, external DC blocking capacitors are required.

4. Typical variation ±5%.

ABSOLUTE MAXIMUM RATINGS⁵

Parameter	Ratings
Operating Temperature	-55°C to +125°C
Storage Temperature	-55°C to +125°C
Input Power ⁶	4 W @ +25°C

5. Permanent damage may occur if any of these limits are exceeded.

6. Power rating applies only to signals within the passband. Power rating above +25°C operating temperature decreases linearly to 0.8 W at +125°C.

TYPICAL FREQUENCY RESPONSE AT +25°C

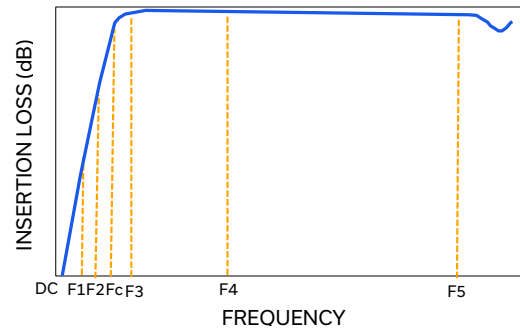



LTCC SURFACE MOUNT

High Pass Filter

HFCG-440+

Mini-Circuits

50Ω

550 to 6000 MHz

TYPICAL PERFORMANCE GRAPHS

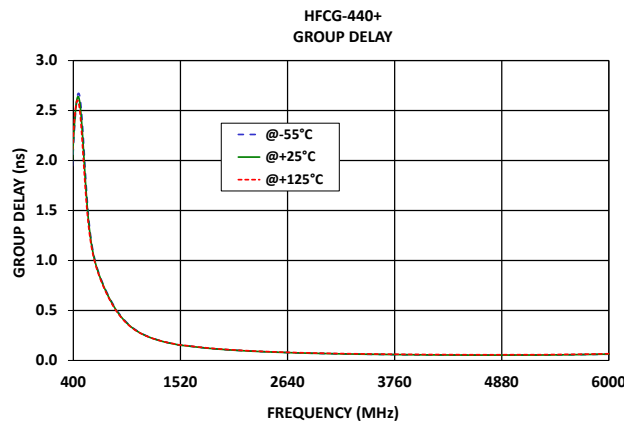
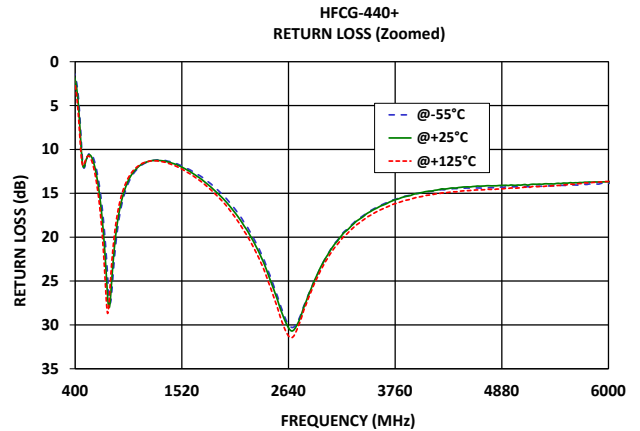
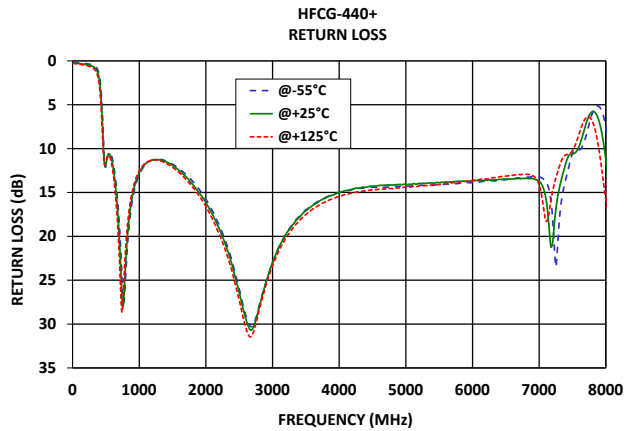
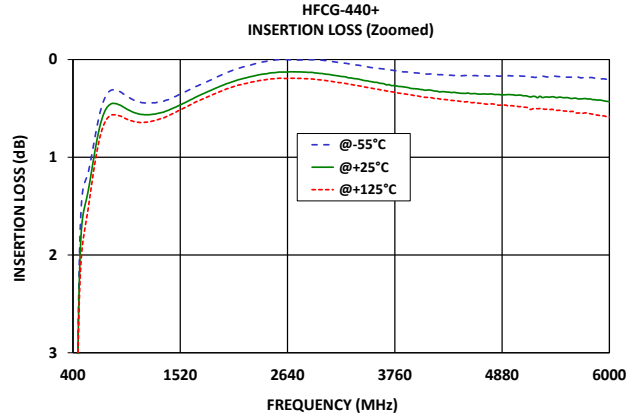
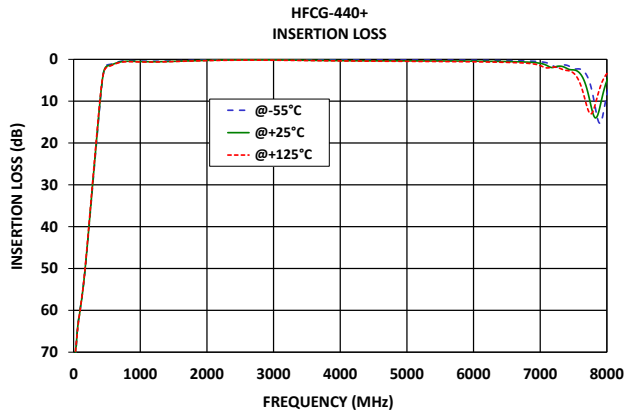



FUNCTIONAL DIAGRAM

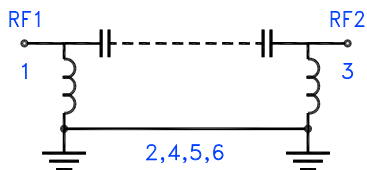
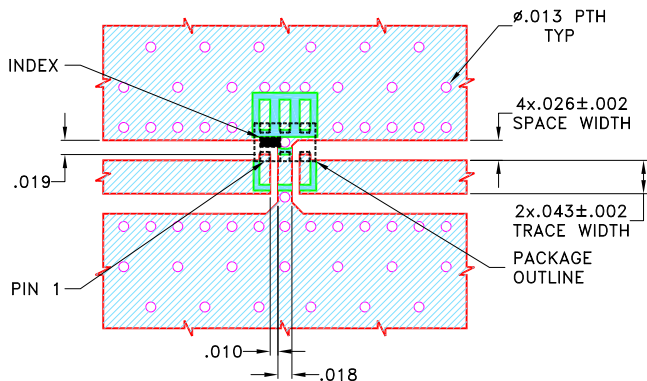

Figure 1. HFCG-440+ Functional Diagram

PAD DESCRIPTION

Function	Pad Number	Description
RF1 ²	1	Connects to RF Input Port
RF2 ²	3	Connects to RF Output Port
GROUND	2,4,5,6	Connects to Ground on PCB, (See drawing PL-633)

SUGGESTED PCB LAYOUT (PL-633)



NOTES:

1. COPLANAR WAVEGUIDE PARAMETERS ARE SHOWN FOR ROGERS (R04350B) WITH DIELECTRIC THICKNESS .020±.0015. COPPER: 1/2 Oz. EACH SIDE. FOR OTHER MATERIALS TRACE WIDTH AND GAP MAY NEED TO BE MODIFIED.
 2. BOTTOM SIDE OF THE PCB IS CONTINUOUS GROUND PLANE.
- DENOTES PCB COPPER PATTERN WITH SMOBC (SOLDER MASK OVER BARE COPPER)
 ▨ DENOTES PCB COPPER PATTERN FREE OF SOLDERMASK

Figure 2. Suggested PCB Layout PL-633

CASE STYLE DRAWING

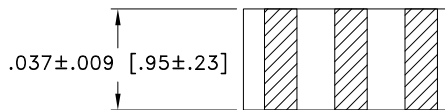
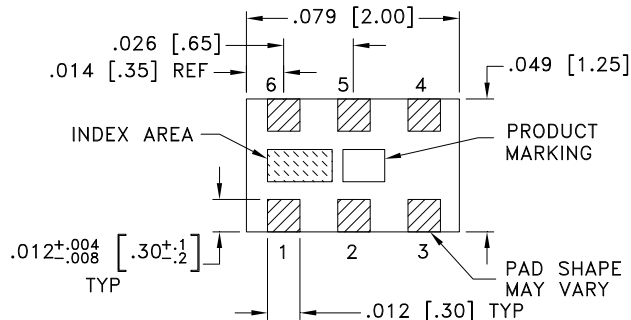

Weight: .008 grams.

Dimensions are in inches (mm). Tolerances: 2Pl. ± .01; 3 Pl. ± .005

PRODUCT MARKING*: E6

*Marking may contain other features or characters for internal lot control.



LTCC SURFACE MOUNT

High Pass Filter

HFCG-440+

50Ω

550 to 6000 MHz

Mini-Circuits

ADDITIONAL DETAILED INFORMATION IS AVAILABLE ON OUR DASHBOARD.

[CLICK HERE](#)

Performance Data and Graphs	Data
	Graphs
	S-Parameter (S2P Files) Data Set (.zip file) De-embedded to device pads
Case Style	GE0805C-9 Lead Finish: Tin over Nickel Plating
RoHS Status	Compliant
Tape and Reel	TR-F114
Suggested Layout for PCB Design	PL-633
Evaluation Board	TB-HFCG-440+
	Gerber File
Environmental Rating	ENV06T11

NOTES

- A. Performance and quality attributes and conditions not expressly stated in this specification document are intended to be excluded and do not form a part of this specification document.
- B. Electrical specifications and performance data contained in this specification document are based on Mini-Circuits' applicable established test performance criteria and measurement instructions.
- C. The parts covered by this specification document are subject to Mini-Circuits' standard limited warranty and terms and conditions (collectively, "Standard Terms"); Purchasers of this part are entitled to the rights and benefits contained therein. For a full statement of the standard terms and the exclusive rights and remedies thereunder, please visit Mini-Circuits' website at www.minicircuits.com/terms/viewterm.html

