



LTCC SURFACE MOUNT

# Bandpass Filter

## BFHKL-1742+

50Ω 16 to 19 GHz

### THE BIG DEAL

- LTCC Band Pass Filter with Integrated Interposer Board
- Wide Stopband Rejection, Typ. 66 dB up to 40 GHz
- Small Size, 4.95 mm x 3.65 mm
- Shielded Construction
- Protected by US Patents 11,638,370 and 11,744,057



Generic photo used for illustration purposes only

### APPLICATIONS

- Test & Measurement Equipment
- Aerospace and Defense Signal Conditioning
- Satellite Communication

### FUNCTIONAL DIAGRAM

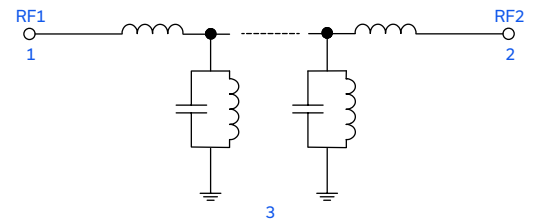

### PRODUCT OVERVIEW

BFHKL-1742+ is a miniature low temperature co-fired ceramic (LTCC) ultra-high stopband rejection band pass filter with a 16 to 19 GHz passband that supports a variety of applications. This model achieves 66 dB typical stopband rejection up to 40 GHz, when mounted on coplanar waveguide layouts. Housed in a small 4.95 mm by 3.65 mm ceramic form factor, the filter is ideal for dense signal chain PCB layouts where it complements MMIC size and performance. The BFHKL family with integrated interposer board enables installation onto PCB layouts with automated manufacturing equipment. This model provides 3 dB typical insertion loss over a wide band due to its rugged monolithic construction. The LTCC fabrication process assures minimal RF performance variation while delivering a product that is well suited for environmental extremes of high humidity and temperature.

### KEY FEATURES

Features	Advantages
Surface Mountable due to Integrated Interposer Board	Enables installation with automated manufacturing equipment, making this suitable for high-volume processes.
Wide Rejection	Provides high stopband rejection of 66 dB typical up to 40 GHz.
Small Size (4.95 x 3.65 mm)	Saves space in dense circuit board layouts and minimizes the effects of parasitics.
LTCC Construction	Provides repeatable performance in a rugged, ceramic package well suited for tough environments such as high humidity and temperature extremes.
Cost Effective	LTCC is a scalable technology that is cost effective due to its ease of production in high-volume.

REV. OR  
ECO-023769  
BFHKL-1742+  
MCL NY  
241127





### ELECTRICAL SPECIFICATIONS<sup>1,2,3</sup> AT +25°C

Parameter	F#	Frequency (GHz)	Min.	Typ.	Max.	Units	
Passband	Center Frequency <sup>4</sup>	—	—	17.4	—	GHz	
	Insertion Loss	F1-F2	16 - 19	—	3	dB	
	Return Loss	F1-F2	16 - 19	—	10.5	dB	
Stopband, Lower	Rejection	DC-F3	0.1 - 10	60	70	—	dB
		F3-F4	10 - 12.9	40	—	—	—
Stopband, Upper	Rejection	F5-F6	23.2 - 30.5	37	47	—	—
		F6-F7	30.5 - 34.4	46	56	—	dB
		F7-F8	34.4 - 40	56	66	—	—

1. Tested on Evaluation Board P/N TB-BFHKI-1742C+. Measured with the connector and feedline effects de-embedded using the 2XThru IEEE P370 method.

2. Bi-directional, RF1 and RF2 ports can be interchanged.

3. This component should not be used as a DC-block. In applications where DC voltage and/or current is present at either the input or output ports, external DC blocking capacitors are required.

4. Typical variation ±3%.

### ABSOLUTE MAXIMUM RATINGS<sup>5</sup>

Parameter	Ratings
Operating Temperature	-55°C to +125°C
Storage Temperature	-55°C to +125°C
Input Power <sup>6</sup>	1 W

5. Permanent damage may occur if any of these limits are exceeded.

6. Power rating applies only to signals within the passband. Power rating above +25°C operating temperature decreases linearly to 0.5 W at +125°C.

### TYPICAL FREQUENCY RESPONSE AT +25°C

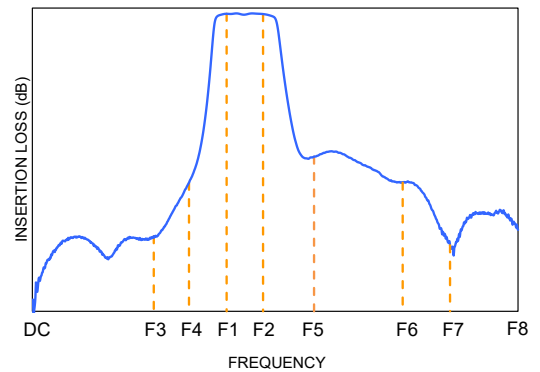



LTCC SURFACE MOUNT

# Bandpass Filter

## BFHKI-1742+

Mini-Circuits

50Ω 16 to 19 GHz

### TYPICAL PERFORMANCE GRAPHS

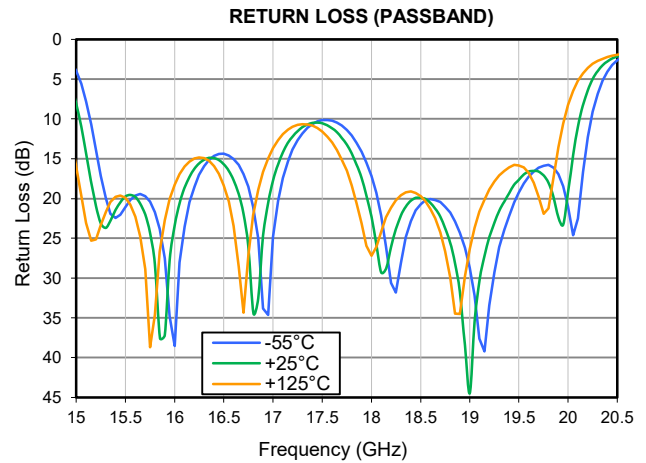
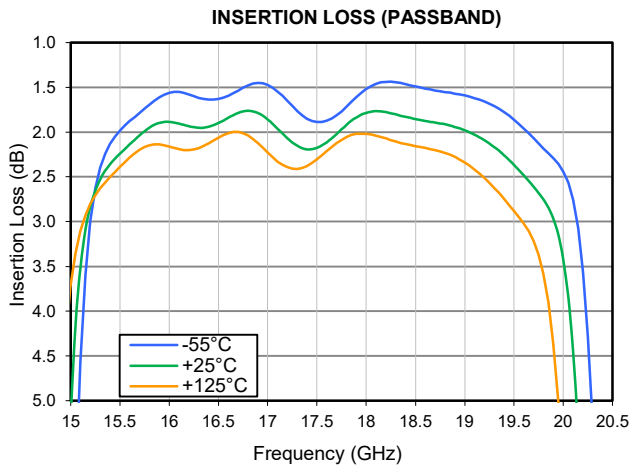
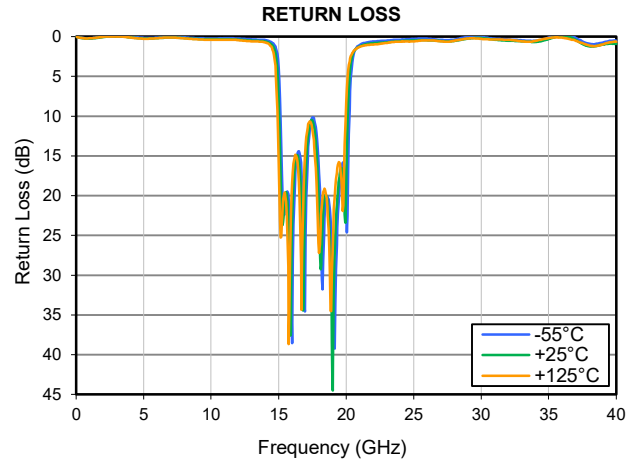
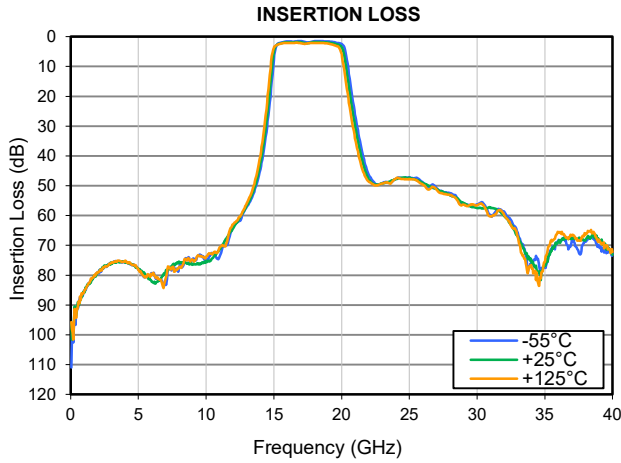



### FUNCTIONAL DIAGRAM

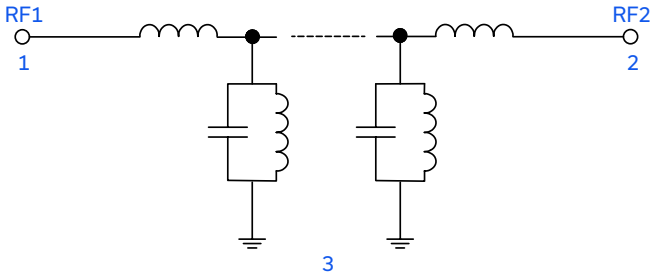
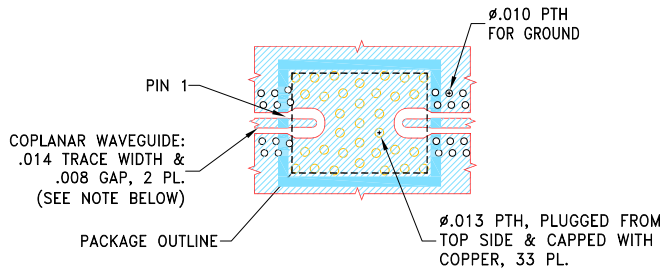

Figure 1. BFHKI-1742+ Functional Diagram

### PAD DESCRIPTION

Function	Pad Number	Description
RF1 <sup>2</sup>	1	Connects to RF Input Port
RF2 <sup>2</sup>	2	Connects to RF Output Port
GROUND	3	Connects to Ground on PCB, (See drawing PL-767)

### SUGGESTED PCB LAYOUT (PL-767)



NOTES:

1. PCB IS MULTILAYER PCB, SEE STACK-UP DIAGRAM.
2. TRACE WIDTH & GAP ARE SHOWN FOR .0079 MEGTRON-7 R5785(N/GN), COPPER: 1/2 OZ. EACH LAYER. FOR OTHER MATERIALS TRACE WIDTH & GAP MAY NEED TO BE MODIFIED.
3. LAYERS L2, L3 & L4 OF PCB ARE CONTINUOUS GROUND PLANES.

DENOTES PCB COPPER LAYOUT WITH SMOBC (SOLDER MASK OVER BARE COPPER).

DENOTES COPPER LAND PATTERN FREE OF SOLDER MASK.

#### STACK-UP DIAGRAM

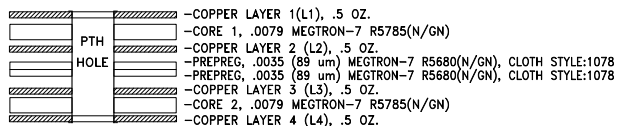

1. TOTAL FINISHED THICKNESS 0.026 ± 10%.
2. PTH PRESENT FROM COPPER LAYER 1 TO COPPER LAYER 4.

Figure 2. Suggested PCB Layout for BFHKI-1742+

### CASE STYLE DRAWING (NM3237)

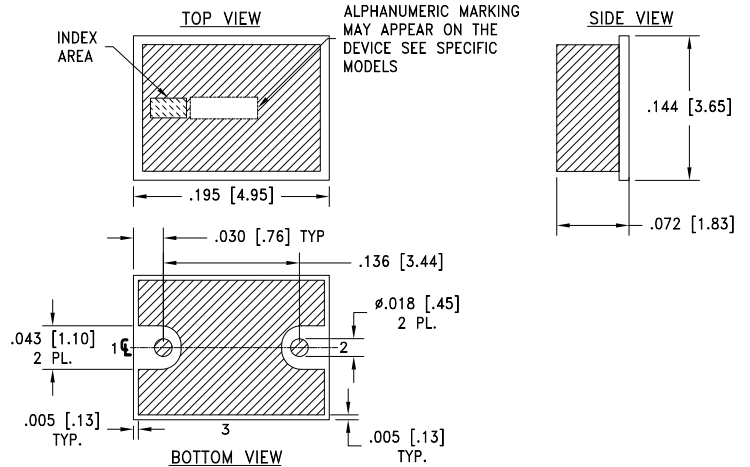

METALLIZATION

Weight: .135 grams.

Dimensions are in inches [mm]. Tolerances: 2 Pl. ±.01; 3 Pl. ±.005

### PRODUCT MARKING\*: F559

\*Marking may contain other features or characters for internal lot control.



LTCC SURFACE MOUNT

# Bandpass Filter

## BFHKI-1742+

50Ω 16 to 19 GHz

**ADDITIONAL DETAILED INFORMATION IS AVAILABLE ON OUR DASHBOARD. [CLICK HERE](#)**

<b>Performance Data &amp; Graphs</b>	Data Graphs S-Parameter (S2P Files) Data Set (.zip file) De-embedded to device pads
<b>Case Style</b>	NM3237 Finish: Gold over Nickel Plating
<b>RoHS Status</b>	Compliant
<b>Tape and Reel</b>	TR-F77
<b>Suggested Layout for PCB Design</b>	PL-767
<b>Evaluation Board</b>	TB-BFHKI-1742C+ Gerber File
<b>Environmental Rating</b>	ENV06T12

**NOTES**

- A. Performance and quality attributes and conditions not expressly stated in this specification document are intended to be excluded and do not form a part of this specification document.
- B. Electrical specifications and performance data contained in this specification document are based on Mini-Circuits' applicable established test performance criteria and measurement instructions.
- C. The parts covered by this specification document are subject to Mini-Circuits' standard limited warranty and terms and conditions (collectively, "Standard Terms"); Purchasers of this part are entitled to the rights and benefits contained therein. For a full statement of the standard terms and the exclusive rights and remedies thereunder, please visit Mini-Circuits' website at [www.minicircuits.com/terms/viewterm.html](http://www.minicircuits.com/terms/viewterm.html)

