



LTCC SURFACE MOUNT

Bandpass Filter

BFHK-2162+

50Ω 19.4 to 23.8 GHz

THE BIG DEAL

- Ultra-High Stopband Rejection, Typ. 70 dB
- Standard Small 1812 (4.5 mm x 3.2 mm) Surface Mount Footprint
- Rugged Ceramic Construction
- Protected by US Patents 11,638,370 and 11,744,057



Generic photo used for illustration purposes only

APPLICATIONS

- Test & Measurement Equipment
- Satellite Communications
- Aerospace and Defense Signal Conditioning

FUNCTIONAL DIAGRAM

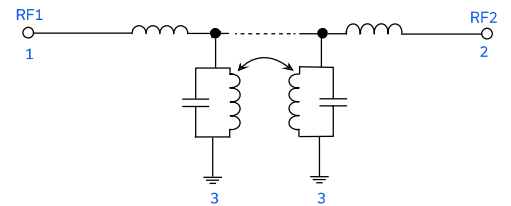

PRODUCT OVERVIEW

The BFHK-2162+ LTCC Bandpass Filter achieves miniature size and highly repeatable performance by utilizing a proprietary LTCC material system and distributed filter topology. The passband loss between 19.4 and 23.8 GHz is typically 2.6 dB, with typical stopband rejection of 75 dB up to 10.3 GHz and 70 dB up to 40 GHz. This model handles up to 1 W RF input power and has a wide operating temperature range from -55°C to +125°C

KEY FEATURES

Features	Advantages
Ultra-High Rejection	Typical stopband rejections at 75 dB up to 10.3 GHz and 70 dB up to 40 GHz.
LTCC Construction	The use of LTCC technology allows for repeatable performance in a rugged ceramic package, well suited for tough environments with high humidity and temperature extremes. See Mini-Circuits Environmental Rating ENV06T12 for more information.
Cost Effective	LTCC is a scalable technology that is cost effective due to ease of production in high quantities.
Small Size 1812 (4.5 mm x 3.2 mm)	Saves space in dense circuit board layouts and minimizes the effects of parasitics.
Surface Mountable	Suitable for very high-volume automated assembly processes.

REV. OR
ECO-023861
BFHK-2162+
MCL NY
241205





ELECTRICAL SPECIFICATIONS^{1,2,3} AT +25°C

Parameter		F#	Frequency (GHz)		Min.	Typ.	Max.	Units
Passband	Center Frequency ⁴	—	—	—	—	21.6	—	GHz
	Insertion Loss	F4-F5	19.4	23.8	—	2.6	4.5	dB
	Return Loss	F4-F5	19.4	23.8	—	12.5	—	dB
Stopband, Lower	Insertion Loss	DC-F1	0.1	5.5	80	100	—	dB
		F1-F2	5.5	10.3	65	75	—	
		F2-F3	10.3	15	60	63	—	
Stopband, Upper	Insertion Loss	F6-F7	29.1	30.9	60	65	—	dB
		F7-F8	30.9	36.3	80	100	—	
		F8-F9	36.3	40	60	70	—	

1. Tested on Evaluation Board P/N TB-BFHK-2162C+ with the connector and feedline effects de-embedded using the 2XThru IEEE P370 method.
2. Bi-directional, RF1 and RF2 ports can be interchanged.
3. In applications where DC voltage and/or current is present at either the input or output ports, external DC blocking capacitors are required.
4. Typical variation ±3.5%.

ABSOLUTE MAXIMUM RATINGS⁵

Parameter	Ratings
Operating Temperature	-55°C to +125°C
Storage Temperature	-55°C to +125°C
Input Power ⁶	1 W

5. Permanent damage may occur if any of these limits are exceeded.
6. Power rating applies only to signals within the passband. Power rating above +25°C operating temperature decreases linearly to 0.5 W at +125°C.

TYPICAL FREQUENCY RESPONSE AT +25°C

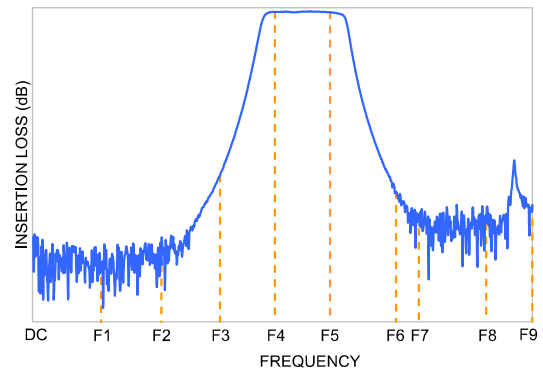



TYPICAL PERFORMANCE GRAPHS

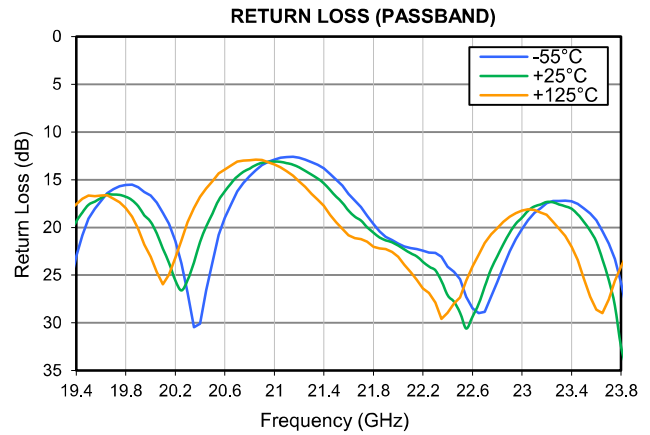
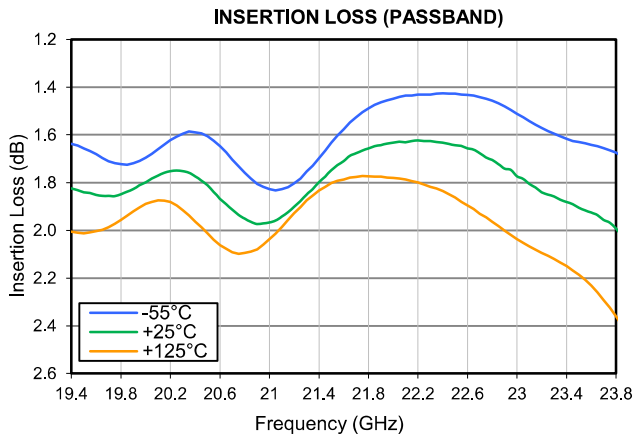
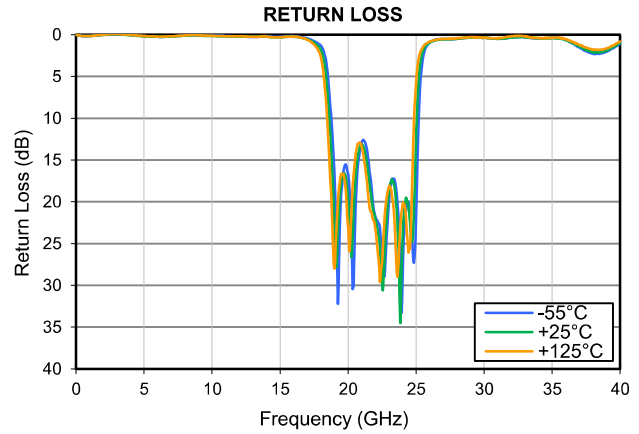
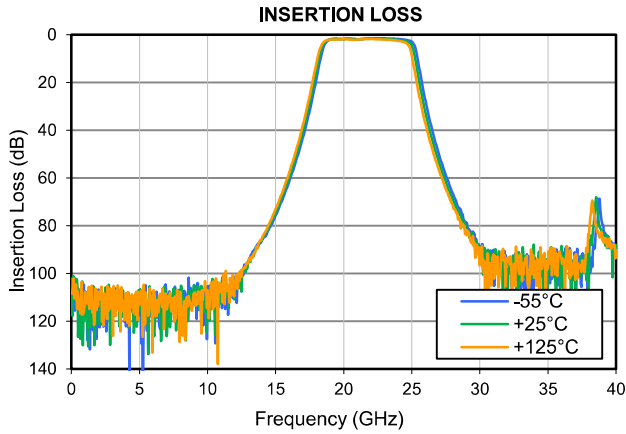



FUNCTIONAL DIAGRAM

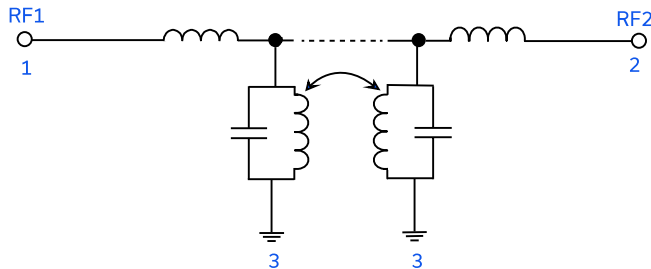
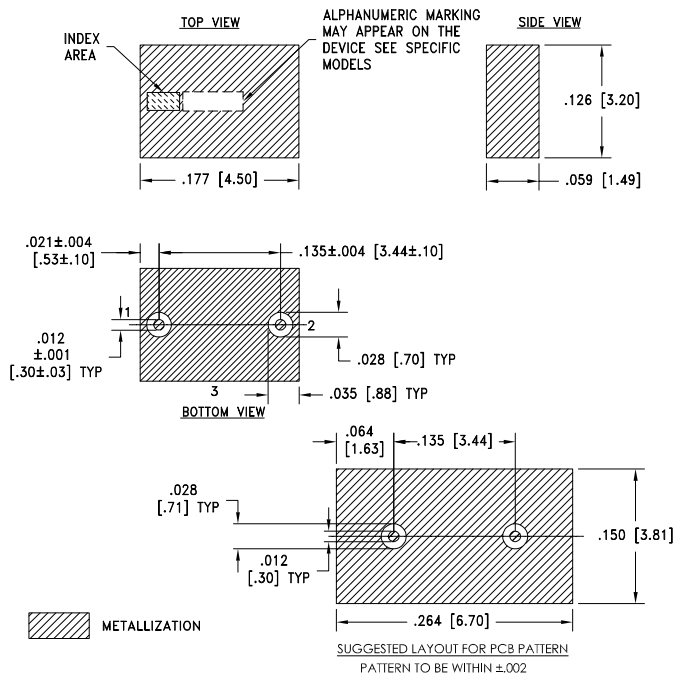

Figure 1. BFHK-2162+ Functional Diagram

PAD DESCRIPTION

Function	Pad Number	Description
RF1 ²	1	Connects to RF Input Port
RF2 ²	2	Connects to RF Output Port
GROUND	3	Connects to Ground on PCB, (See drawing PL-730)

CASE STYLE DRAWING



Weight: .126 grams
Dimensions are in inches [mm]. Tolerances: 2PI.±.01; 3PI. ±.005

SUGGESTED PCB LAYOUT (PL-730)

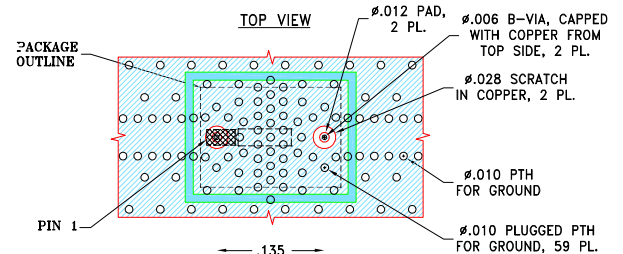

- TOP-SOLDERMASK.
- COPPER LAYER 1, .5 OZ. + PLATING
- CORE, .0051 MEGTRON6 R-5775(G), CLOTH STYLE:1080
- COPPER LAYER 2, .5 OZ. + PLATING.
- PREPREG, .0041 MEGTRON6 R-5670(G)
- COPPER LAYER 3, .5 OZ.
- CORE, .0051 MEGTRON6 R-5775(G), CLOTH STYLE:1080
- COPPER LAYER 4, .5 OZ. + PLATING

- TOTAL FINISHED THICKNESS 0.0228±.004.
- B-VIA PRESENT FROM COPPER LAYER 1 TO COPPER LAYER 2.
- PTH PRESENT FROM COPPER LAYER 1 TO COPPER LAYER 4.
- INDICATED PLUGGED PTH'S ARE PLUGGED WITH EPOXY AND CAPPED WITH COPPER FROM TOP SIDE.
- LAYER 4 IS CONTINUOUS GROUND PLANE.

NOTES:

- PCB IS MULTILAYER PCB, SEE STACK-UP DIAGRAM.
- TRACE WIDTH & GAP PARAMETERS ARE SHOWN FOR MEGTRON6 R-5775(G), CLOTH STYLE:1080 WITH DIELECTRIC THICKNESS .0051; COPPER: 1/2 OZ.+PLATING. FOR OTHER MATERIALS TRACE WIDTH AND GAP MAY NEED TO BE MODIFIED.
- COPPER LAYER 4 OF THE PCB ARE CONTINUOUS GROUND PLANE.

- DENOTES PCB COPPER LAYOUT WITH SMOBC (SOLDER MASK OVER BARE COPPER)
- DENOTES COPPER LAND PATTERN FREE OF SOLDER MASK

LAYER 2, B-VIA & PTH

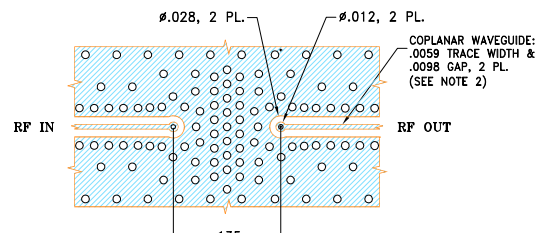

LAYER 3 & PTH

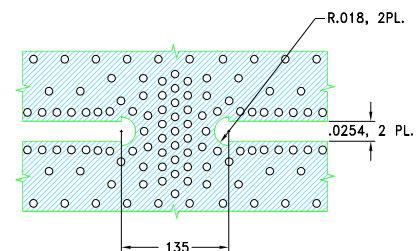

Figure 2. Suggested PCB Layout for BFHK-2162+

PRODUCT MARKING*: F560

*Marking may contain other features or characters for internal lot control.



LTCC SURFACE MOUNT

Bandpass Filter

BFHK-2162+

50Ω 19.4 to 23.8 GHz

ADDITIONAL DETAILED INFORMATION IS AVAILABLE ON OUR DASHBOARD. [CLICK HERE](#)

Performance Data & Graphs	Data Graphs S-Parameter (S2P Files) Data Set (.zip file) De-embedded to device pads
Case Style	NM1812C-3 Lead Finish: Tin over Nickel Plating
RoHS Status	Compliant
Tape and Reel	F77
Suggested Layout for PCB Design	PL-730
Evaluation Board	TB-BFHK-2162C+ Gerber File
Environmental Rating	ENV06T12

NOTES

- A. Performance and quality attributes and conditions not expressly stated in this specification document are intended to be excluded and do not form a part of this specification document.
- B. Electrical specifications and performance data contained in this specification document are based on Mini-Circuit's applicable established test performance criteria and measurement instructions.
- C. The parts covered by this specification document are subject to Mini-Circuits standard limited warranty and terms and conditions (collectively, "Standard Terms"); Purchasers of this part are entitled to the rights and benefits contained therein. For a full statement of the standard terms and the exclusive rights and remedies thereunder, please visit Mini-Circuits' website at www.minicircuits.com/terms/viewterm.html

