

Evaluation Board and Circuit

TB-LFCW-5000+

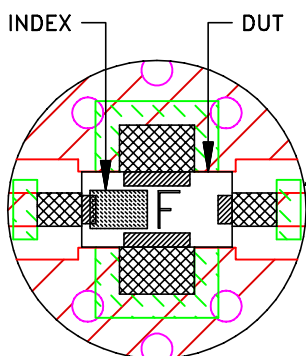

Schematic diagram

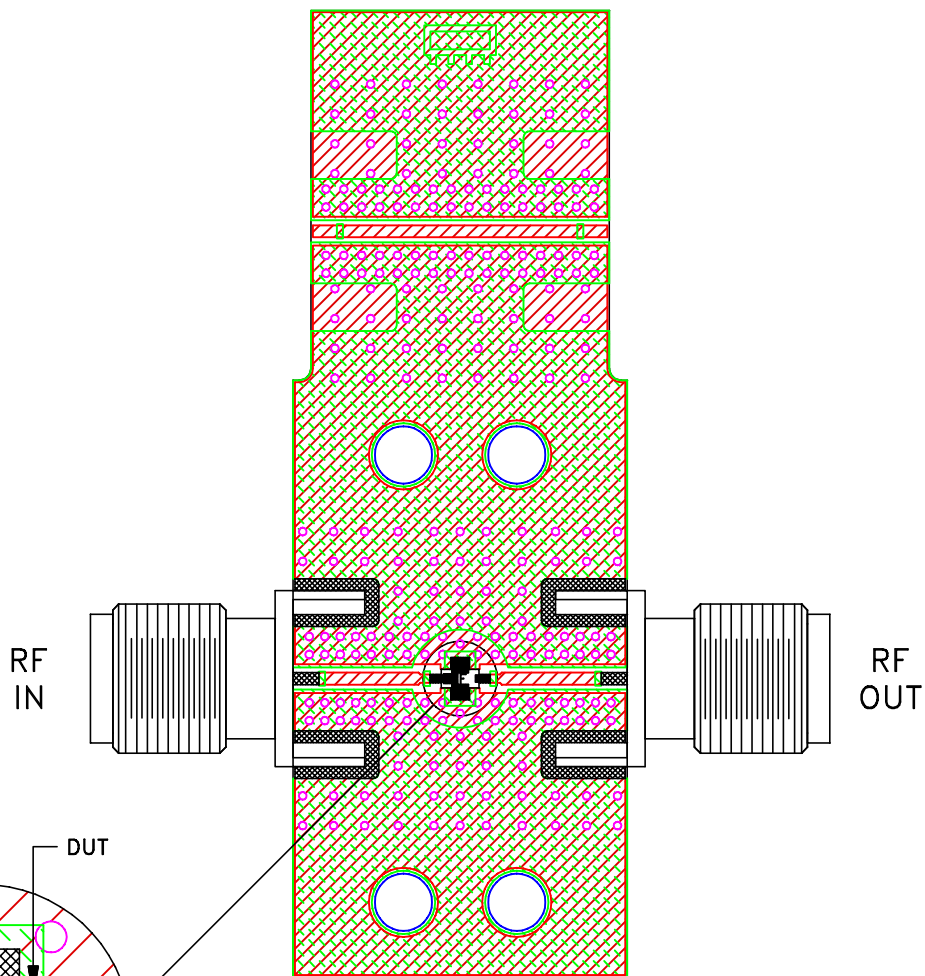
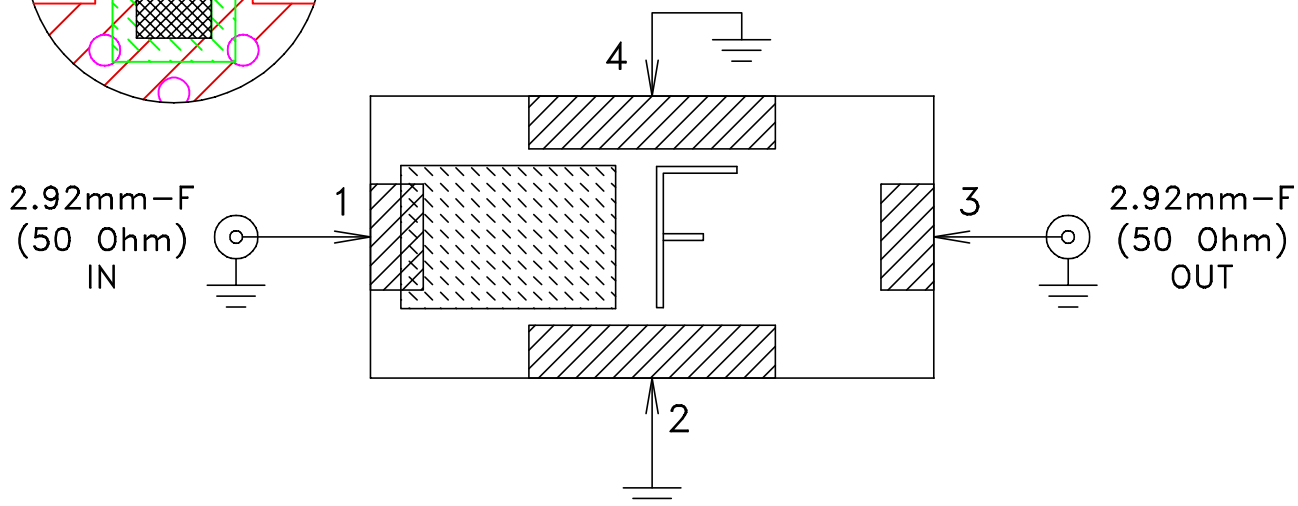

Notes:

1. PCB Material: ROGERS (RO4835 Lo Pro) OR Equivalent, Dielectric Constant= 3.48 ± 0.05
Dielectric Thickness: $.0107 \pm .0010$
2. 50 Ohm 2.92mm Female Connectors.
3. Connectors on the test board shall not be subjected to temperature greater than 200°C to avoid permanent damage to the connectors.

 **Mini-Circuits®**