

Coaxial Reflectionless Low Pass Filter

ZXLF Series

50Ω

DC to 11 GHz



The Big Deal

- Patented design terminates Stopband signals
- Stopband up to 35 GHz
- High Stopband rejection, up to 50 dB

Product Overview

Mini-Circuits' ZXLF Series reflectionless filters employ a novel filter topology which absorbs and terminates stop band signals internally rather than reflecting them back to the source. Reflectionless filters eliminate stopband reflections, allowing them to be paired with sensitive devices and used in applications that otherwise require circuits such as isolation amplifiers or attenuators. This is developed in a new broadband, stable connectorized package.

Key Features

Feature	Advantages
Easy integration with sensitive reflective components, e.g. mixers, multipliers	Reflectionless filters absorb unwanted signals, preventing reflections back to the source. This reduces generation of additional unwanted signals without the need for extra components like attenuators, improving system dynamic range.
Cascadable	Reflectionless filters can be cascaded in multiple sections to provide sharper and higher attenuation, while also preventing any standing waves that could affect pass band signals.
Excellent stability over temperature	Minimal variation in electrical performance across temperature.
Operating temperature up to 105°C	Suitable for operation close to high power components.
Broadband connectorized package	The connectorized package works well even in high frequencies and easy to interface with other devices. This is well suited for test setups.

Notes

- A. Performance and quality attributes and conditions not expressly stated in this specification document are intended to be excluded and do not form a part of this specification document.
B. Electrical specifications and performance data contained in this specification document are based on Mini-Circuit's applicable established test performance criteria and measurement instructions.
C. The parts covered by this specification document are subject to Mini-Circuits standard limited warranty and terms and conditions (collectively, "Standard Terms"); Purchasers of this part are entitled to the rights and benefits contained therein. For a full statement of the Standard Terms and the exclusive rights and remedies thereunder, please visit Mini-Circuits' website at www.minicircuits.com/MCLStore/terms.jsp



Low Pass Filter

ZXLF-K63H+

50Ω DC to 6820 MHz



Generic photo used for illustration purposes only

Features

- Match to 50Ω in the stop band, eliminates undesired reflections
- Cascadable
- Temperature stable, up to 105°C
- Protected by US Patents 8,392,495; 9,705,467, additional patent pending
- Protected by China Patent 201080014266.1
- Protected by Taiwan Patent I581494

Applications

- Telecomm
- 5G & WiFi

CASE STYLE: UK3042
Connectors Model
2.92mm-F ZXLF-K63H+

Electrical Specifications at 25°C

Parameter		F#	Frequency (MHz)	Min.	Typ.	Max.	Unit
Pass Band	Insertion Loss	DC-F1	DC- 6820	-	2.2	3.0	dB
		F2	10500	-	3.5	-	dB
		VSWR	DC- 6820	-	1.3	-	:1
Stop Band	Rejection	F3-F4	14500 - 16300	17	29	-	dB
		F4-F5	16300 - 20000	30	43	-	dB
		F5-F6	20000 - 24000	-	44	-	dB
	VSWR	F3-F4	14500 - 16300	-	1.3	-	:1
		F4-F5	16300 - 20000	-	1.2	-	:1
		F5-F6	20000 - 24000	-	2.0	-	:1

Absolute Maximum Ratings³

Parameter	Ratings
Operating Temperature	-55°C to +105°C
Storage Temperature	-55°C to +105°C
RF Power Input, Passband (DC-F1) ¹	4W at 25°C
RF Power Input, Stopband (F2-F6) ²	1.6W at 25°C

- ¹ Passband rating derates linearly to 2W at 105°C ambient
² Stopband rating derates linearly to 0.8W at 105°C ambient
³ Permanent damage may occur if any of these limits are exceeded

ESD rating

Human body model (HBM): Class 1A (Pass 250 V) in accordance with ANSI/ESD 5.1-2001

Functional Schematic

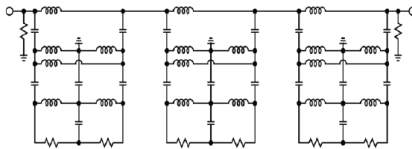

Typical Frequency Response

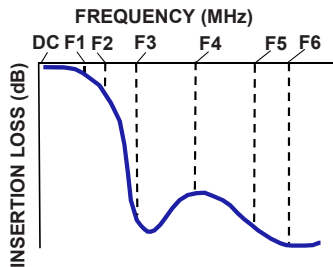

Typical Performance Data at 25°C

Frequency (MHz)	Insertion Loss (dB)	VSWR (:1)
1	0.58	1.04
10	0.54	1.04
100	0.58	1.04
200	0.65	1.06
220	0.66	1.06
300	0.69	1.08
500	0.77	1.12
1000	0.97	1.25
5000	1.86	1.23
6820	2.17	1.21
9000	2.79	1.03
10500	3.59	1.22
11000	4.01	1.30
12000	5.27	1.28
14500	21.87	1.39
15000	26.63	1.17
16300	38.11	1.11
20000	41.14	1.16
24000	50.09	1.88
40000	57.81	3.01

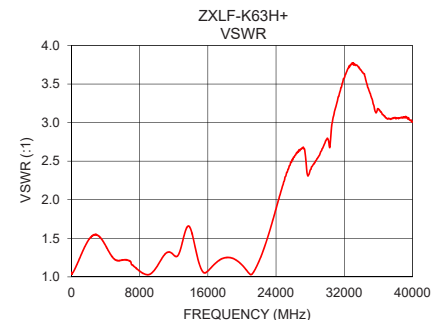
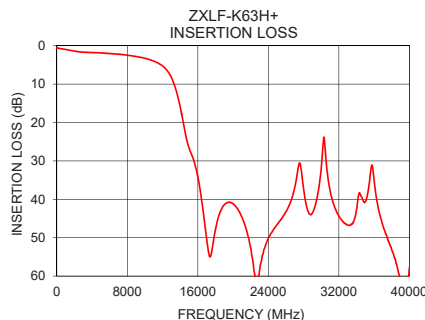

+RoHS Compliant

The +Suffix identifies RoHS Compliance. See our web site for RoHS Compliance methodologies and qualifications

Notes

- A. Performance and quality attributes and conditions not expressly stated in this specification document are intended to be excluded and do not form a part of this specification document.
 B. Electrical specifications and performance data contained in this specification document are based on Mini-Circuit's applicable established test performance criteria and measurement instructions.
 C. The parts covered by this specification document are subject to Mini-Circuits standard limited warranty and terms and conditions (collectively, "Standard Terms"); Purchasers of this part are entitled to the rights and benefits contained therein. For a full statement of the Standard Terms and the exclusive rights and remedies thereunder, please visit Mini-Circuits' website at www.minicircuits.com/MCLStore/terms.jsp



Coaxial Connections

PORT - 1	2.92mm-Female
PORT - 2	2.92mm-Female

Outline Drawing



Outline Dimensions (inch/mm)

A	B	C	D	E	F
.68	.60	.39	.200	.10	.400
17.1	15.2	10.0	5.08	2.5	10.16
G	H	J	K	Wt.	
.24	.070	.22	.30	grams	
6.0	1.78	5.5	7.6	24	

Note: Please refer to case style drawing for details

Notes

- A. Performance and quality attributes and conditions not expressly stated in this specification document are intended to be excluded and do not form a part of this specification document.
- B. Electrical specifications and performance data contained in this specification document are based on Mini-Circuit's applicable established test performance criteria and measurement instructions.
- C. The parts covered by this specification document are subject to Mini-Circuits standard limited warranty and terms and conditions (collectively, "Standard Terms"); Purchasers of this part are entitled to the rights and benefits contained therein. For a full statement of the Standard Terms and the exclusive rights and remedies thereunder, please visit Mini-Circuits' website at www.minicircuits.com/MCLStore/terms.jsp

Coaxial Reflectionless Low Pass Filter

ZXLF-K63H+

Typical Performance Data

FREQ.	Insertion Loss	Input Return Loss	Output Return Loss	FREQ.	Group Delay
(MHz)	(dB)	(dB)	(dB)	(MHz)	(ns)
1	0.58	33.93	34.04	1	0.25
5	0.53	34.50	34.34	40	0.23
10	0.54	34.34	34.36	100	0.23
15	0.54	34.23	34.33	200	0.22
25	0.55	34.12	34.24	300	0.22
40	0.56	33.92	33.95	400	0.22
100	0.58	33.87	33.88	500	0.22
200	0.65	30.94	30.80	600	0.22
300	0.69	28.53	28.31	700	0.22
400	0.74	26.53	26.31	800	0.22
500	0.77	24.82	24.53	900	0.22
600	0.81	23.31	23.03	1000	0.22
700	0.85	22.10	21.79	1100	0.21
800	0.88	20.96	20.75	1200	0.21
900	0.93	20.03	19.70	1300	0.21
1000	0.97	19.18	18.86	1400	0.21
1100	1.01	18.39	18.11	1500	0.21
1200	1.05	17.74	17.48	1600	0.21
1300	1.09	17.11	16.87	1700	0.21
1400	1.14	16.58	16.34	1800	0.21
1500	1.18	16.08	15.85	1900	0.21
1600	1.21	15.65	15.47	2000	0.21
1700	1.27	15.27	15.10	2100	0.21
1800	1.30	14.94	14.75	2200	0.21
1900	1.34	14.61	14.45	2300	0.21
2000	1.39	14.34	14.20	2400	0.21
3000	1.67	13.41	13.42	2500	0.21
4000	1.77	15.38	15.68	2600	0.21
5000	1.86	19.59	21.53	2700	0.21
6000	2.03	20.11	23.55	2800	0.21
6100	2.05	20.07	23.19	2900	0.21
6600	2.13	20.17	21.99	3000	0.21
6820	2.17	20.60	21.78	3100	0.21
7000	2.19	21.42	22.21	3200	0.21
8600	2.65	34.96	24.07	3300	0.21
9000	2.79	36.99	24.63	3400	0.21
9100	2.84	36.87	24.79	3500	0.21
9200	2.87	35.49	24.91	3600	0.21
9300	2.92	34.16	24.82	3700	0.21
9400	2.96	32.83	24.79	3800	0.21
10000	3.25	24.44	22.03	3900	0.21
10500	3.59	20.12	18.88	4000	0.21
11000	4.01	17.79	16.65	4100	0.21
11200	4.21	17.32	16.20	4200	0.21
13000	8.28	14.85	14.03	4300	0.21
14500	21.87	15.68	15.33	4400	0.21
15000	26.63	22.13	20.32	4500	0.21
16300	38.11	25.77	25.82	4600	0.21
17000	50.34	21.40	23.24	4700	0.21
17200	53.62	20.63	22.73	4800	0.21
17500	54.36	19.86	22.29	4900	0.22
18000	47.87	19.17	22.02	5000	0.22
18500	43.47	19.06	22.25	5100	0.22
19000	41.42	19.48	23.13	5200	0.22
19500	40.79	20.65	25.06	5300	0.22
20000	41.14	22.85	29.41	5400	0.22
21000	44.60	36.83	28.40	5500	0.22
24000	50.09	10.29	8.87	6000	0.22
30000	31.85	6.50	6.17	6600	0.22
40000	57.81	5.99	5.66	6820	0.22

Typical Performance Curves

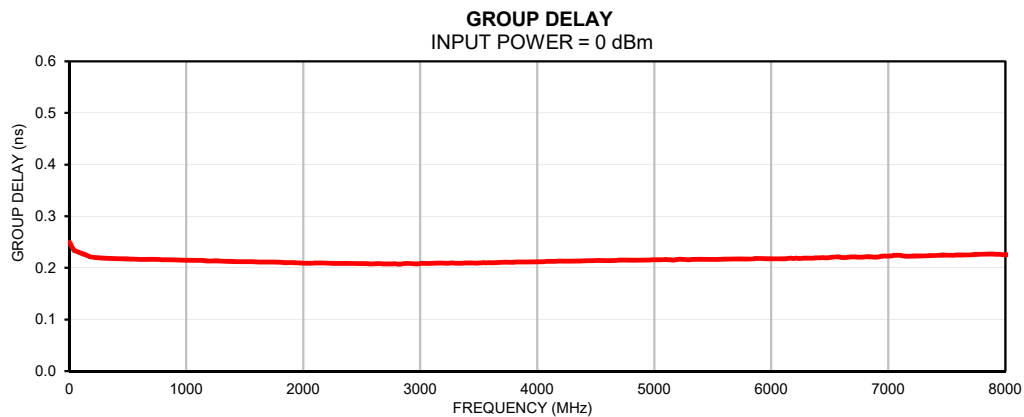
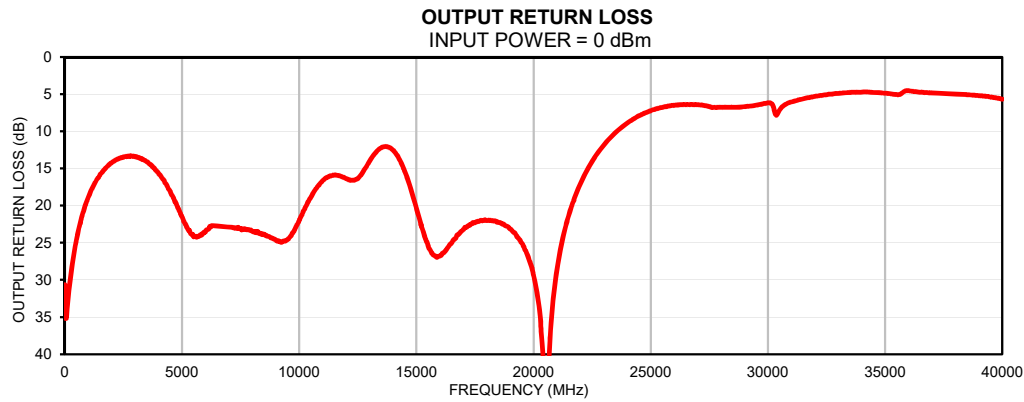
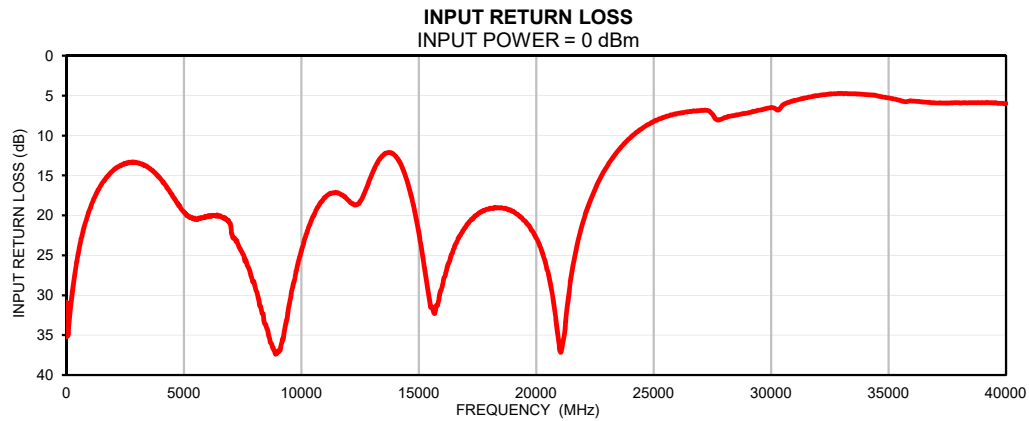
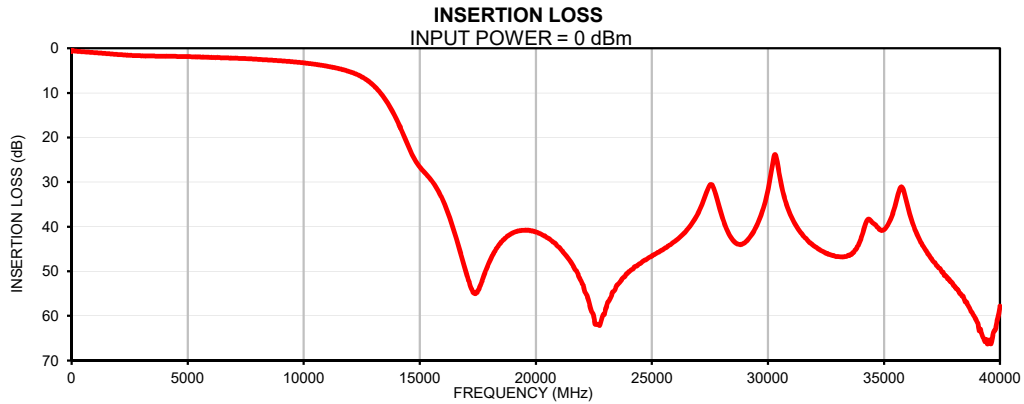

Outline Dimensions

UK3042

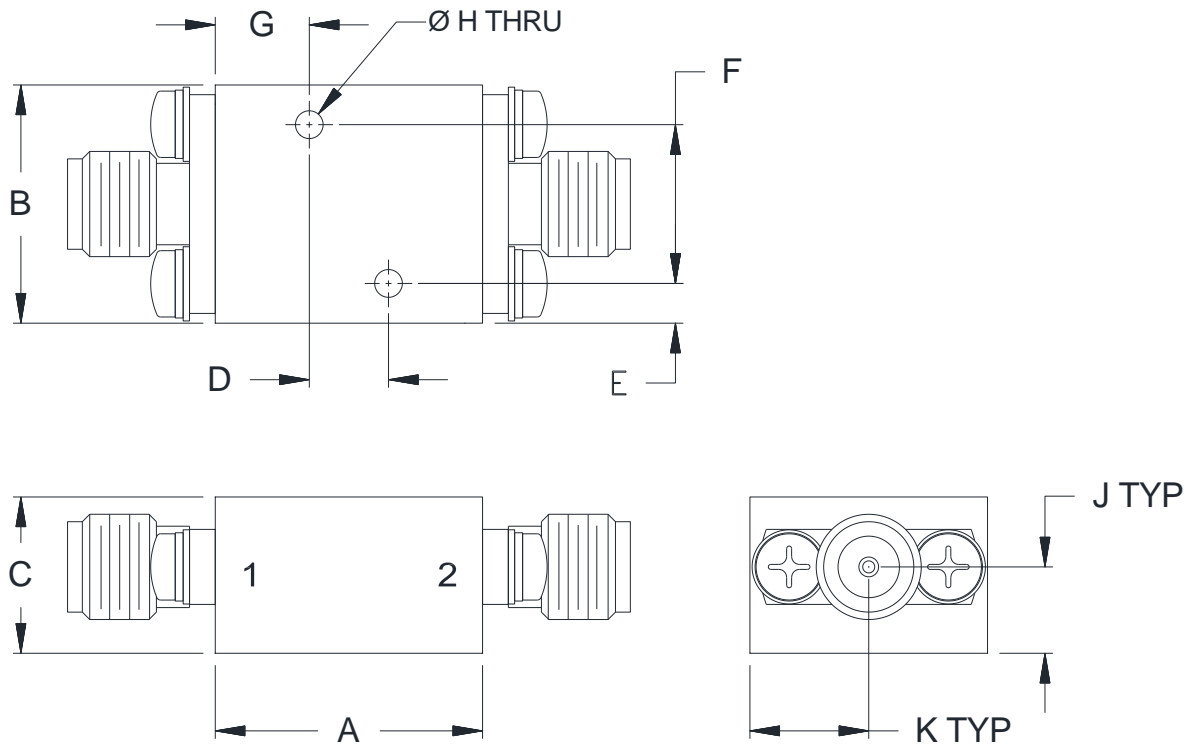

CASE#	A	B	C	D	E	F
UK3042	.68 (17.1)	.60 (15.2)	.39 (10.0)	.200 (5.08)	.10 (2.5)	.400 (10.16)

CASE#	G	H	J	K	WT.GRAMS
UK3042	.24 (6.0)	.070 (1.78)	.22 (5.5)	.30 (7.6)	24

Dimensions are in inches (mm). Tolerances: 2 Pl. $\pm .050$; 3 Pl. $\pm .015$

Notes:

1. Case material: Brass alloy.
2. Case Finish:
 - a. Case & Cover of the units –Gold plating.
3. Refer to the individual model data sheet for the type of connectors available.



P.O. Box 350166, Brooklyn, New York 11235-0003 (718) 934-4500 Fax (718) 332-4661 For detailed performance specs & shopping online see Mini-Circuits web site



The Design Engineers Search Engine Provides ACTUAL Data Instantly From MINI-CIRCUITS At: www.minicircuits.com

RF/IF MICROWAVE COMPONENTS

All Mini-Circuits products are manufactured under exacting quality assurance and control standards, and are capable of meeting published specifications after being subjected to any or all of the following physical and environmental test.

Specification	Test/Inspection Condition	Reference/Spec
Operating Temperature	-55° to 105°C Ambient Environment	Individual Model Data Sheet
Storage Temperature	-55° to 105°C Ambient Environment	Individual Model Data Sheet