

# Coaxial Reflectionless Low Pass Filter

## ZXLF Series

50Ω DC to 11 GHz



### The Big Deal

- Patented design terminates Stopband signals
- Stopband up to 35 GHz
- High Stopband rejection, up to 50 dB

### Product Overview

Mini-Circuits' ZXLF Series reflectionless filters employs a novel filter topology which absorbs and terminates stop band signals internally rather than reflecting them back to the source. Reflectionless filters eliminate stopband reflections, allowing them to be paired with sensitive devices and used in applications that otherwise require circuits such as isolation amplifiers or attenuators. This is developed in a new broadband, stable connectorized package.

### Key Features

Feature	Advantages
Easy integration with sensitive reflective components, e.g. mixers, multipliers	Reflectionless filters absorb unwanted signals, preventing reflections back to the source. This reduces generation of additional unwanted signals without the need for extra components like attenuators, improving system dynamic range.
Cascadable	Reflectionless filters can be cascaded in multiple sections to provide sharper and higher attenuation, while also preventing any standing waves that could affect pass band signals.
Excellent stability over temperature	Minimal variation in electrical performance across temperature.
Operating temperature up to 105°C	Suitable for operation close to high power components.
Broadband connectorized package	The connectorized package works well even in high frequencies and easy to interface with other devices. This is well suited for test setups.

#### Notes

- A. Performance and quality attributes and conditions not expressly stated in this specification document are intended to be excluded and do not form a part of this specification document.  
B. Electrical specifications and performance data contained in this specification document are based on Mini-Circuit's applicable established test performance criteria and measurement instructions.  
C. The parts covered by this specification document are subject to Mini-Circuits standard limited warranty and terms and conditions (collectively, "Standard Terms"); Purchasers of this part are entitled to the rights and benefits contained therein. For a full statement of the Standard Terms and the exclusive rights and remedies thereunder, please visit Mini-Circuits' website at [www.minicircuits.com/MCLStore/terms.jsp](http://www.minicircuits.com/MCLStore/terms.jsp)



# Low Pass Filter

## ZXLF-K13H+

50Ω DC to 1000 MHz



Generic photo used for illustration purposes only

CASE STYLE: UK3042  
 Connectors Model  
 2.92mm-F ZXLF-K13H+

### Features

- Match to 50Ω in the stop band, eliminates undesired reflections
- Cascadable
- Temperature stable, up to 105°C
- Protected by US Patents 8,392,495; 9,705,467, additional patent pending
- Protected by China Patent 201080014266.1
- Protected by Taiwan Patent I581494

### Applications

- Telecomm
- Military / Defense
- ISM band
- GPS

### Electrical Specifications at 25°C

Parameter	F#	Frequency (MHz)	Min.	Typ.	Max.	Unit
Pass Band	Insertion Loss	DC-F1	DC- 1000	-	2.8	3.6 dB
	Freq. Cut-off	F2	1300	-	3.8	dB
	VSWR	DC-F1	DC- 1000	-	1.3	:1
Stop Band	Rejection	F3-F4	1850 - 2500	12	25	- dB
		F4-F5	2500 - 10000	35	47	- dB
		F5-F6	10000 - 19000	-	50	- dB
	VSWR	F3-F4	1850 - 2500	-	1.4	- :1
		F4-F5	2500 - 10000	-	1.3	- :1
		F5-F6	10000 - 19000	-	2.2	- :1

### Absolute Maximum Ratings<sup>3</sup>

Parameter	Ratings
Operating Temperature	-55°C to +105°C
Storage Temperature	-55°C to +105°C
RF Power Input, Passband (DC-F1) <sup>1</sup>	7.9W at 25°C
RF Power Input, Stopband (F2-F6) <sup>2</sup>	1.58W at 25°C

<sup>1</sup> Passband rating derates linearly to 3.9W at 105°C ambient

<sup>2</sup> Stopband rating derates linearly to 0.75W at 105°C ambient

<sup>3</sup> Permanent damage may occur if any of these limits are exceeded

### ESD rating

Human body model (HBM): Class 1B (pass 500V) in accordance with ANSI/ESD 5.1-2001

### Functional Schematic

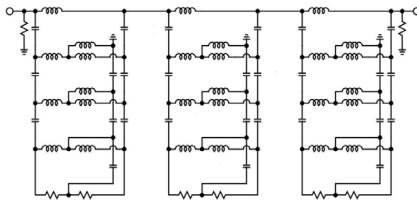

### Typical Frequency Response

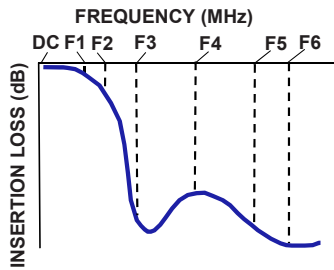

### Typical Performance Data at 25°C

Frequency (MHz)	Insertion Loss (dB)	VSWR (:1)
1	1.41	1.26
10	1.42	1.26
100	1.45	1.24
200	1.56	1.27
500	1.98	1.32
800	2.46	1.26
900	2.63	1.21
1000	2.83	1.16
1300	3.80	1.11
1850	16.94	1.26
1900	21.89	1.31
2000	33.86	1.39
2500	41.15	1.43
5000	56.02	1.15
10000	41.54	1.55
11000	44.92	1.70
15000	57.70	1.96
18000	66.27	2.37
19000	63.88	2.42
20000	60.54	2.45

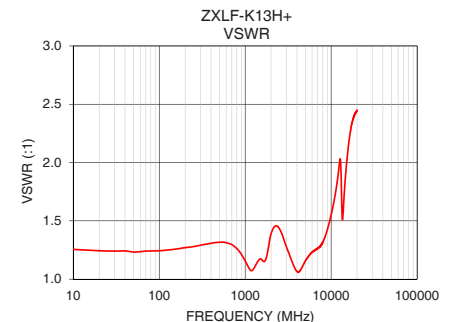
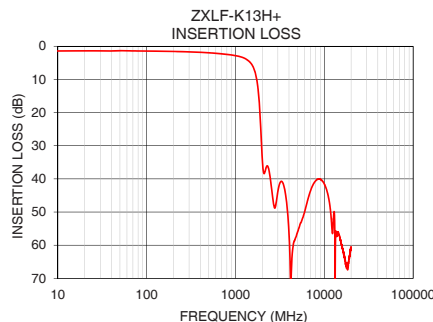

**+RoHS Compliant**

The +Suffix identifies RoHS Compliance. See our web site for RoHS Compliance methodologies and qualifications

#### Notes

- Performance and quality attributes and conditions not expressly stated in this specification document are intended to be excluded and do not form a part of this specification document.
- Electrical specifications and performance data contained in this specification document are based on Mini-Circuit's applicable established test performance criteria and measurement instructions.
- The parts covered by this specification document are subject to Mini-Circuits standard limited warranty and terms and conditions (collectively, "Standard Terms"); Purchasers of this part are entitled to the rights and benefits contained therein. For a full statement of the Standard Terms and the exclusive rights and remedies thereunder, please visit Mini-Circuits' website at [www.minicircuits.com/MCLStore/terms.jsp](http://www.minicircuits.com/MCLStore/terms.jsp)



## Coaxial Connections

PORT - 1	2.92mm-Female
PORT - 2	2.92mm-Female

## Outline Drawing

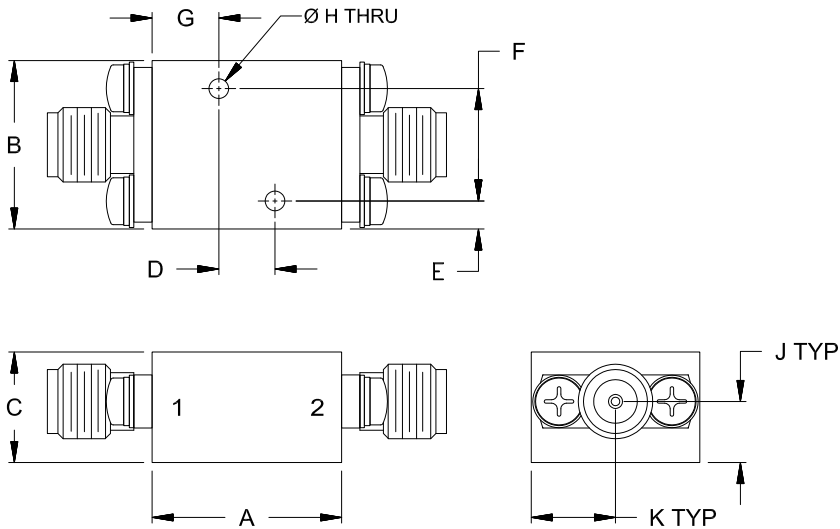

## Outline Dimensions (inch/mm)

A	B	C	D	E	F
<b>.68</b>	<b>.60</b>	<b>.39</b>	<b>.200</b>	<b>.10</b>	<b>.400</b>
17.1	15.2	10.0	5.08	2.5	10.16
G	H	J	K	Wt.	
<b>.24</b>	<b>.070</b>	<b>.22</b>	<b>.30</b>	grams	
6.0	1.78	5.5	7.6	<b>24</b>	

Note: Please refer to case style drawing for details

### Notes

- A. Performance and quality attributes and conditions not expressly stated in this specification document are intended to be excluded and do not form a part of this specification document.
- B. Electrical specifications and performance data contained in this specification document are based on Mini-Circuit's applicable established test performance criteria and measurement instructions.
- C. The parts covered by this specification document are subject to Mini-Circuits standard limited warranty and terms and conditions (collectively, "Standard Terms"); Purchasers of this part are entitled to the rights and benefits contained therein. For a full statement of the Standard Terms and the exclusive rights and remedies thereunder, please visit Mini-Circuits' website at [www.minicircuits.com/MCLStore/terms.jsp](http://www.minicircuits.com/MCLStore/terms.jsp)

# Coaxial Reflectionless Low Pass Filter

# ZXLF-K13H+

## Typical Performance Data

FREQ.	Insertion Loss	Input Return Loss	Output Return Loss	FREQ.	Group Delay
(MHz)	(dB)	(dB)	(dB)	(MHz)	(ns)
1	1.41	18.84	18.91	1	0.53
5	1.44	18.76	18.77	10	0.53
10	1.42	18.91	18.92	20	0.53
20	1.39	19.27	19.27	50	0.53
40	1.42	19.31	19.33	100	0.53
60	1.38	19.56	19.54	110	0.53
100	1.45	19.27	19.28	120	0.53
160	1.52	18.88	18.82	130	0.53
200	1.56	18.68	18.48	140	0.53
240	1.62	18.40	18.30	150	0.53
300	1.70	18.12	17.93	160	0.53
360	1.77	17.91	17.67	170	0.53
400	1.83	17.74	17.51	180	0.53
440	1.88	17.66	17.37	190	0.53
500	1.98	17.58	17.28	200	0.53
560	2.06	17.59	17.27	210	0.53
600	2.13	17.67	17.37	220	0.53
680	2.26	18.03	17.66	230	0.53
700	2.29	18.14	17.79	240	0.53
800	2.46	19.01	18.73	250	0.53
900	2.63	20.50	20.28	260	0.53
1000	2.83	22.94	22.82	270	0.53
1300	3.80	26.07	25.77	280	0.53
1500	5.24	22.32	21.93	290	0.53
1850	16.94	19.13	18.87	300	0.53
2000	33.86	15.73	15.77	310	0.53
2500	41.15	14.75	15.01	320	0.53
3000	43.73	17.71	18.14	330	0.53
3700	45.58	25.52	25.77	340	0.53
3800	48.22	27.35	27.14	350	0.53
4000	56.39	30.99	29.94	360	0.53
4500	59.34	27.31	27.47	370	0.53
5000	56.02	22.58	22.89	380	0.53
5500	53.01	20.73	20.79	390	0.53
6000	49.92	20.03	19.75	400	0.53
6500	46.39	20.02	19.12	410	0.53
7000	43.54	20.14	18.57	420	0.53
7500	41.65	20.38	18.11	430	0.53
8000	40.57	19.41	17.40	500	0.53
8500	40.06	17.63	16.26	520	0.53
9000	40.16	15.82	15.20	540	0.53
9500	40.64	14.17	14.21	560	0.54
10000	41.54	12.80	13.30	580	0.54
10500	42.92	11.63	12.47	600	0.54
11000	44.92	10.61	11.73	620	0.54
11500	47.76	9.70	10.99	640	0.54
11000	44.92	10.61	11.73	660	0.54
11500	47.76	9.70	10.99	680	0.55
12000	52.59	8.83	10.26	700	0.55
13000	51.03	8.25	9.89	720	0.55
13500	55.80	11.11	13.79	740	0.55
14000	56.70	9.87	12.14	760	0.56
15000	57.70	8.19	9.78	780	0.56
15500	59.72	7.84	9.15	800	0.56
16000	61.08	7.65	8.69	820	0.57
17000	64.54	7.66	8.11	840	0.57
18000	66.27	8.02	7.81	900	0.58
18500	66.06	8.26	7.72	920	0.59
19000	63.88	8.45	7.65	960	0.60
20000	60.54	8.44	7.53	1000	0.61

## Typical Performance Curves

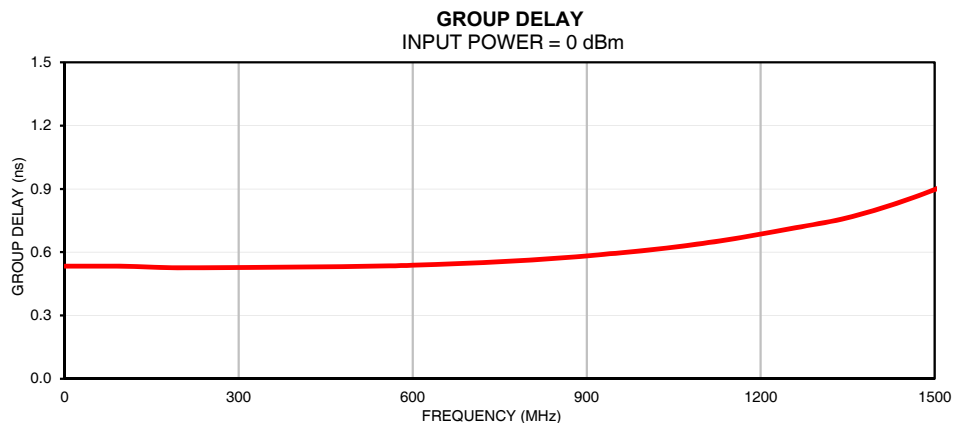
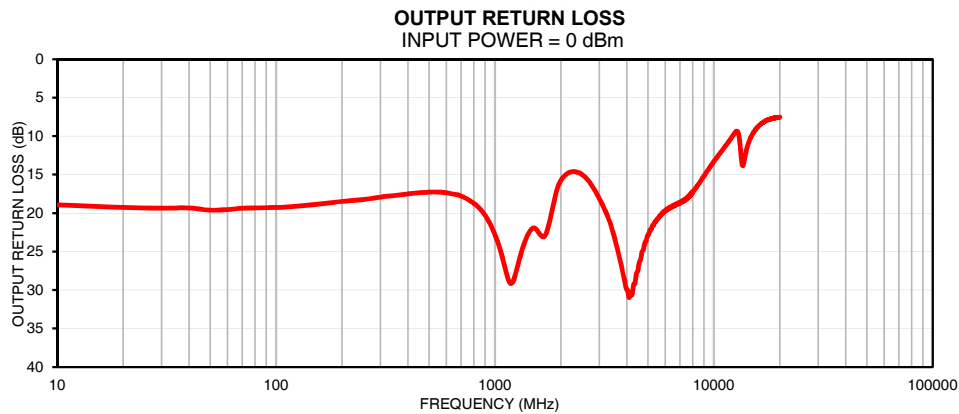
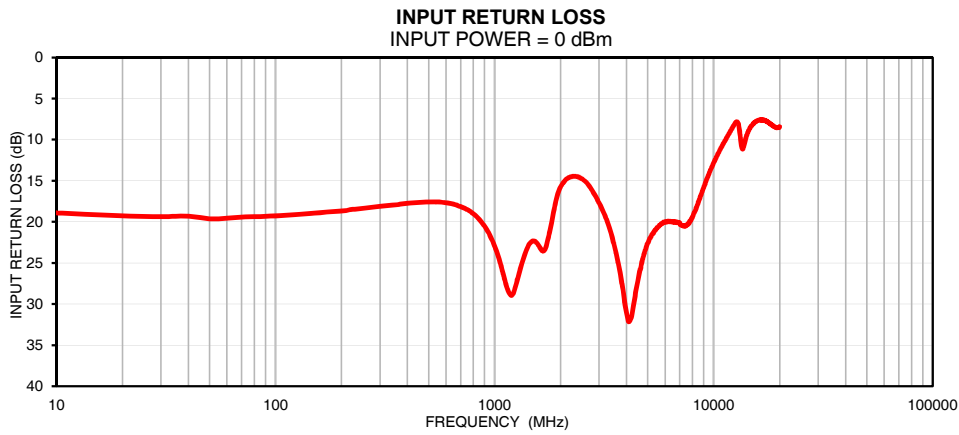
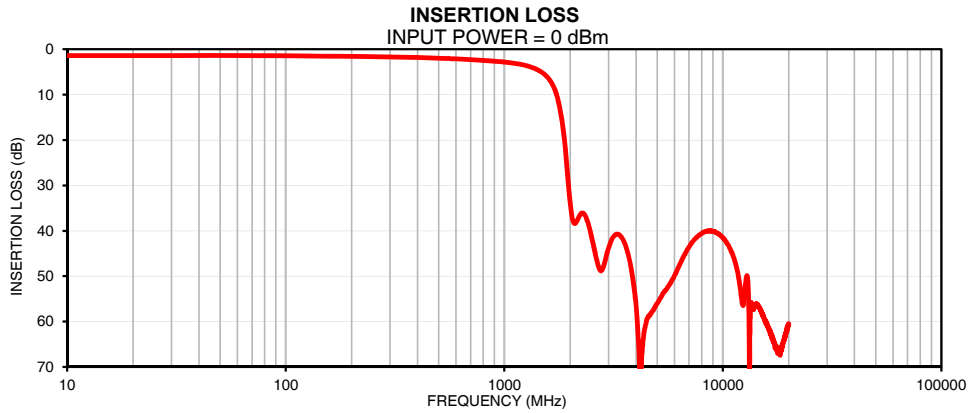

## Outline Dimensions

UK3042

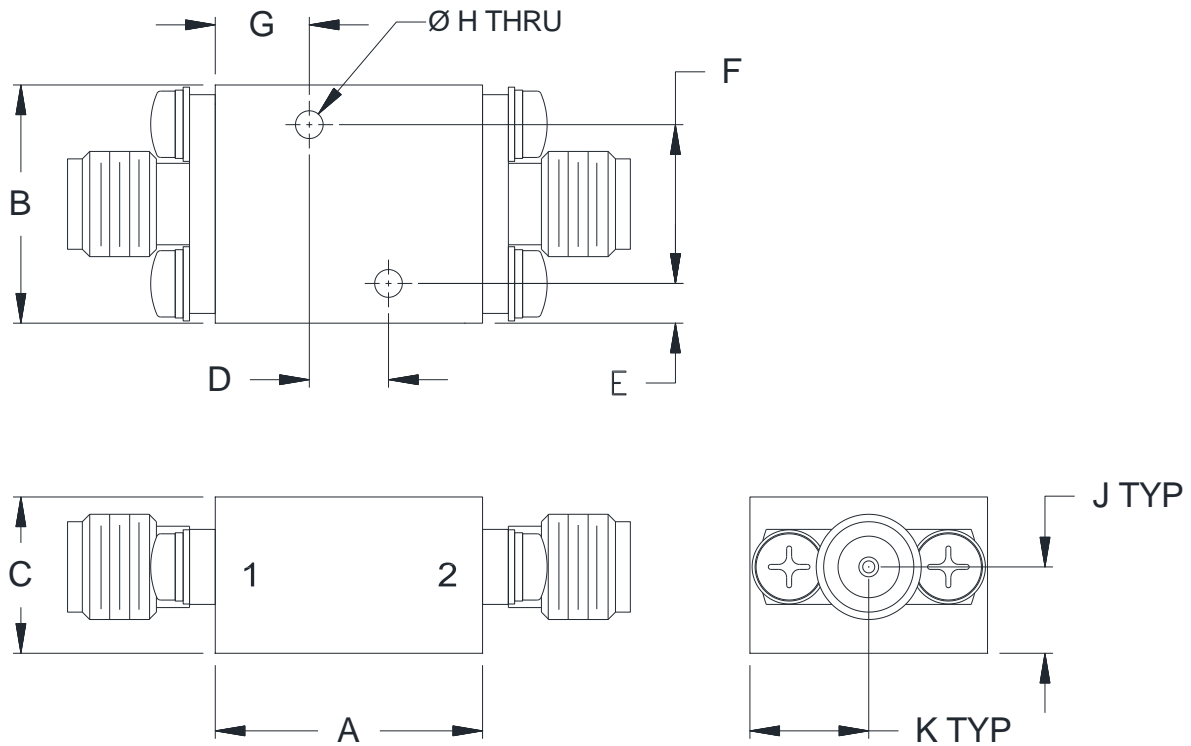

CASE#	A	B	C	D	E	F
UK3042	.68 (17.1)	.60 (15.2)	.39 (10.0)	.200 (5.08)	.10 (2.5)	.400 (10.16)

CASE#	G	H	J	K	WT.GRAMS
UK3042	.24 (6.0)	.070 (1.78)	.22 (5.5)	.30 (7.6)	24

Dimensions are in inches (mm). Tolerances: 2 Pl.  $\pm .050$ ; 3 Pl.  $\pm .015$

### Notes:

1. Case material: Brass alloy.
2. Case Finish:
  - a. Case & Cover of the units –Gold plating.
3. Refer to the individual model data sheet for the type of connectors available.



P.O. Box 350166, Brooklyn, New York 11235-0003 (718) 934-4500 Fax (718) 332-4661 For detailed performance specs & shopping online see Mini-Circuits web site



The Design Engineers Search Engine Provides ACTUAL Data Instantly From MINI-CIRCUITS At: [www.minicircuits.com](http://www.minicircuits.com)

RF/IF MICROWAVE COMPONENTS

All Mini-Circuits products are manufactured under exacting quality assurance and control standards, and are capable of meeting published specifications after being subjected to any or all of the following physical and environmental test.

<b>Specification</b>	<b>Test/Inspection Condition</b>	<b>Reference/Spec</b>
Operating Temperature	-55° to 105°C Ambient Environment	Individual Model Data Sheet
Storage Temperature	-55° to 105°C Ambient Environment	Individual Model Data Sheet