



COAXIAL WIDEBAND

Digital Step Attenuator **ZX76-31R5A-SPS+**

50Ω 31.5 dB, 0.5 dB Step DC to 4 GHz

THE BIG DEAL

- 6-bit digital step attenuator
- Serial 3-wire control interface
- Low insertion loss
- Fast attenuation transitions
- No control software or PC required



Generic photo used for illustration purposes only

Model No.	ZX76-31R5A-SPS+
Case Style	HK172
Connectors	SMA

APPLICATIONS

- Test Setup
- Lab
- Instrumentation

RoHS Compliant

See our website for RoHS Compliance methodologies and qualifications

PRODUCT OVERVIEW

ZX76-31R5A-SPS+ is a 6-bit digital step attenuator with serial control and single positive supply voltage inputs. Attenuation can be set from 0 to 31.5 dB in 0.5 dB steps, with 0.1 dB typical accuracy. The attenuator is housed in a compact unibody package, with SMA RF connections and a snap-fit control input.

The serial 3-wire serial control interface supports simple integration with a wide range of microcontroller and custom I/O (input / output) control systems. Data is clocked into the internal 6-bit shift register using 5V logic levels and then latched to set the attenuation.

For applications requiring Ethernet / USB control and software support, please review Mini-Circuits' R_DAT series of programmable attenuators at <https://www.minicircuits.com/WebStore/RF-Programmable-Step-Attenuators.html>.

KEY FEATURES

Feature	Advantages
Wideband operation, from DC to 4 GHz	Supports a range of applications in communications, satellite and defense.
Excellent RF performance	Low insertion loss and 18 dB typical return loss minimize the impact on overall system performance.
Single voltage supply inputs	Use of single positive supply simplifies power supply design. An internal negative voltage generator supplies the desired negative voltage. Single positive supply results in excellent spurious performance, -140 dBm typical
Serial 3-wire control	Designed for integration with generic control systems at 5V logic levels, no PC or control software required.

RF ELECTRICAL SPECIFICATIONS, DC - 4 GHz, $T_{AMB}=25^{\circ}\text{C}$, $V_{DD}=+3\text{V}$

Parameter	Frequency (MHz)	Min.	Typ.	Max.	Units
Insertion Loss @ 0dB Attenuation Setting	DC - 1000	—	1.4	2.0	dB
	1000 - 2400	—	1.9	2.7	
	2400 - 4000	—	2.5	3.3	
Accuracy @ 0.5 dB Attenuation Setting	DC - 1000	—	± 0.03	± 0.10	dB
	1000 - 2400	—	± 0.05	± 0.15	
	2400 - 4000	—	± 0.07	± 0.20	
Accuracy @ 1 dB Attenuation Setting	DC - 1000	—	± 0.02	± 0.10	dB
	1000 - 2400	—	± 0.05	± 0.15	
	2400 - 4000	—	± 0.10	± 0.25	
Accuracy @ 2 dB Attenuation Setting	DC - 1000	—	± 0.05	± 0.15	dB
	1000 - 2400	—	± 0.15	± 0.25	
	2400 - 4000	—	± 0.15	± 0.35	
Accuracy @ 4 dB Attenuation Setting	DC - 1000	—	± 0.07	± 0.20	dB
	1000 - 2400	—	± 0.15	± 0.25	
	2400 - 4000	—	± 0.23	± 0.50	
Accuracy @ 8 dB Attenuation Setting	DC - 1000	—	± 0.03	± 0.25	dB
	1000 - 2400	—	± 0.15	± 0.50	
	2400 - 4000	—	± 0.60	± 0.80	
Accuracy @ 16 dB Attenuation Setting	DC - 1000	—	± 0.10	± 0.30	dB
	1000 - 2400	—	± 0.15	± 0.70	
	2400 - 4000	—	± 1.10	± 1.45	
Input IP3 (at Min. and Max. Attenuation) ¹	DC - 4000	—	+52	—	dBm
Input Power @ 0.2dB Compression (at Min. and Max. Attenuation) ¹	DC - 4000	—	+24	—	
Input Operating Power	0.010 - 50	—	—	See figure 1	dBm
	50 - 4000	—	—	+24	
Return Loss	DC - 1000	12.5	21	—	dB
	1000 - 2400	11.5	18	—	
	2400 - 4000	10.0	14	—	

1. Input IP3 and 1dB compression degrade below 1 MHz. Input power not to exceed max operating specification for continuous operation.

DC ELECTRICAL SPECIFICATIONS

Parameter	Min.	Typ.	Max.	Units
Positive Supply Voltage, V_{DD}	+2.3	+3	+3.6	V
Positive Supply Current, I_{DD}	—	—	200	μA
Control Input Low	-0.3	—	+0.3x V_{DD}	V
Control Input High	+0.7x V_{DD}	—	+5	V
Control Current	—	—	400	μA

SWITCHING SPECIFICATIONS

Parameter	Min.	Typ.	Max.	Units
Switching Speed, 50% Control to 0.5dB of Attenuation Value	—	1	—	μsec
Switching Control Frequency	—	25	—	kHz

FIGURE 1: Max Input Operating Power vs Frequency

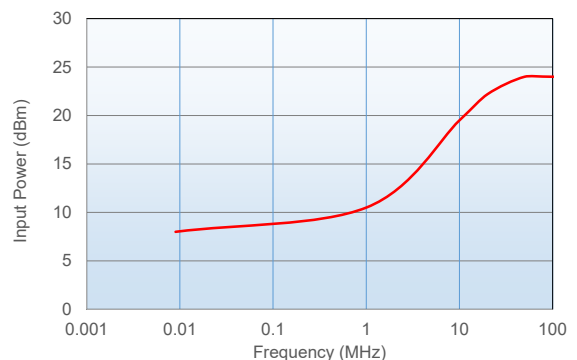



ABSOLUTE MAXIMUM RATINGS

Parameter	Ratings
Operating Temperature	-40°C to 85°C
Storage Temperature	-40°C to 85°C
V _{DD}	-0.3V Min., +3.6V Max.
V _{SS}	-3.6V Min., +0.3V Max.
Voltage on any control input	-0.3V Min., +6V Max.
ESD, HBM	500V
ESD, MM	100V
Input Power	+30dBm

Permanent damage may occur if any of these limits are exceeded. Operating in the range between operating power limits and absolute maximum ratings for extended periods of time may result in reduced life and reliability.

PIN CONFIGURATION

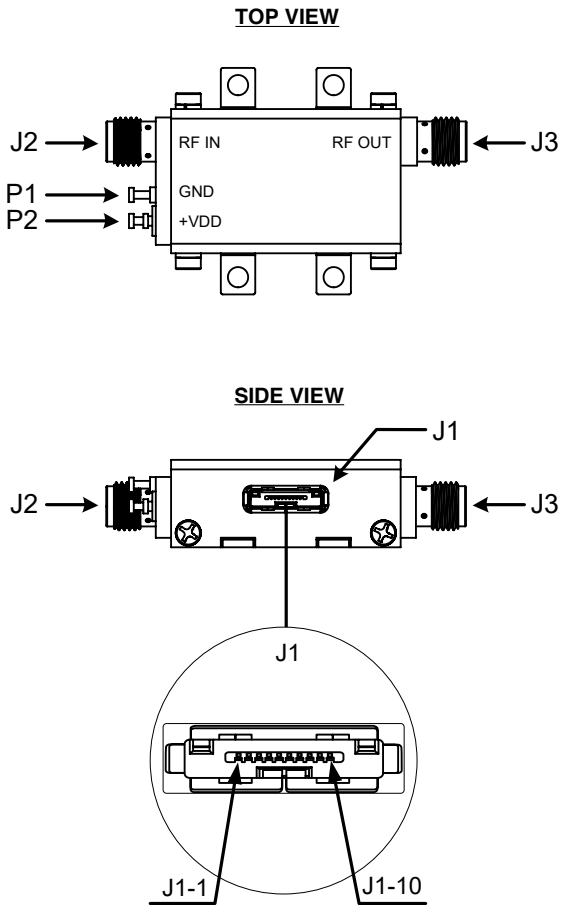

PIN DESCRIPTION

Function	Pin Number	Description
N/C	J1-1	Not Connected
GND	J1-2	Ground connection
LE	J1-3	Latch Enable Input
N/C	J1-4	Not Connected
GND	J1-5	Ground connection
N/C	J1-6	Not Connected
Clock	J1-7	Serial Interface clock Input
GND	J1-8	Ground connection
Data	J1-9	Serial Interface data Input
N/C	J1-10	Not Connected
RF in	J2	RF in port (Note 1)
RF out	J3	RF out port (Note 1)
GND	P1	Ground connection
V _{DD}	P2	Positive Supply Voltage

² Both RF ports must be held at 0VDC or DC blocked with an external series capacitor.



SIMPLIFIED SCHEMATIC

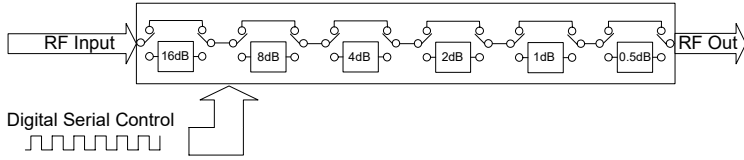

The ZX76-31R5A-SPS+ serial interface consists of 6 control bits that select the desired attenuation state, as shown in Table 1: Truth Table.

TABLE 1. TRUTH TABLE

Attenuation State	C16	C8	C4	C2	C1	C0.5
Reference	0	0	0	0	0	0
0.5 (dB)	0	0	0	0	0	1
1 (dB)	0	0	0	0	1	0
2 (dB)	0	0	0	1	0	0
4 (dB)	0	0	1	0	0	0
8 (dB)	0	1	0	0	0	0
16 (dB)	1	0	0	0	0	0
31.5 (dB)	1	1	1	1	1	1

Note: Not all 64 possible combinations of C0.5 - C16 are shown in table

The serial interface is a 6-bit serial in, parallel-out shift register buffered by a transparent latch.

It is controlled by three CMOS-compatible signals: Data, Clock, and Latch Enable (LE). The Data and Clock inputs allow data to be serially entered into the shift register, a process that is independent of the state of the LE input. The shift register triggers on the rising edge of the clock signal.

The LE input controls the latch. When LE is HIGH, the latch is transparent and the contents of the serial shift register control the attenuator. When LE is brought LOW, data in the shift register is latched.

The shift register should be loaded while LE is held LOW to prevent the attenuator value from changing as data is entered. The LE input should then be toggled HIGH and brought LOW again, latching the new data.

The timing for this operation is defined by Figure 2 (Serial Interface Timing Diagram) and Table 2 (Serial Interface AC Characteristics).

TABLE 2. SERIAL INTERFACE AC CHARACTERISTICS

Symbol	Parameter	Min.	Max.	Units
f_{clk}	Serial data clock frequency ³		10	MHz
t_{clkH}	Serial clock HIGH time	30		ns
t_{clkL}	Serial clock LOW time	30		ns
t_{LESUP}	LE set-up time after last clock rising edge	10		ns
t_{LEPW}	LE minimum pulse width	30		ns
t_{SDSUP}	Serial data set-up rising edge	10		ns
t_{SDHLD}	Serial data hold time after clock rising edge	10		ns

³ f_{clk} verified during the functional pattern test. Serial programming sections of the functional pattern are clocked at 10MHz to verify f_{clk} specification.

FIGURE 1: SERIAL INTERFACE TIMING DIAGRAM

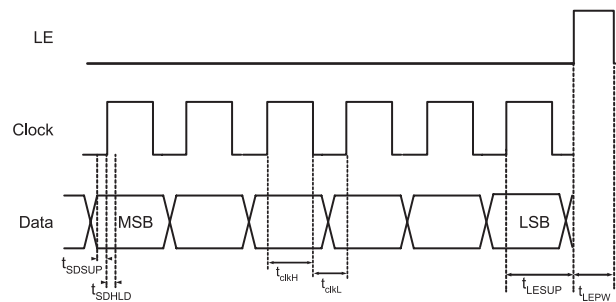

POWER-UP STATE

When the attenuator powers up and LE is logic low, the nominal attenuation is set on 0 dB. When LE is logic high, the nominal attenuation selected upon control logics (see Table 1).



ZX76-WS+ CONTROL CABLE

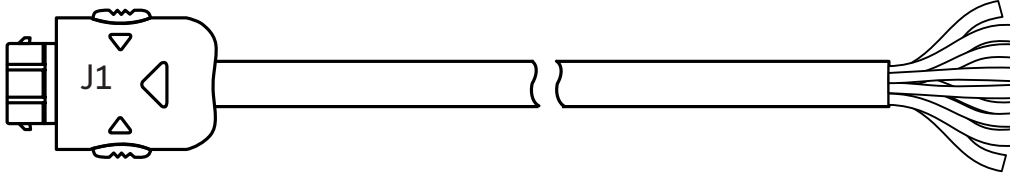

RECOMMENDED ACCESSORIES

An optional ZX76-WS+ is a shielded cable on one end and a connector on the other end designed to mate to the ZX76-31R5A-SPS+. These bare wires enable the customer to assemble their own cable as required to interface with the ZX76-31R5A-SPS+ (cable length is 4.9ft/ 1.5meters).

ZX76-WS+ WIRING INFORMATION

J1 Pin Number	Function	Description	Wire Color
J1-2	GND	Ground Connection	Black
J1-3	LE	Latch Enable Input	Green
J1-5	GND	Ground Connection	Blue
J1-7	Clock	Serial Interface Clock Input	Red
J1-8	GND	Ground Connection	Orange
J1-9	Data	Serial Interface Data Input	White

Note: Other pins not connected. Cable shield connected to case ground.



TYPICAL PERFORMANCE DATA (AT 25°C)

Freq. [MHz]	I.Loss [dB]	Attenuation relative to Insertion Loss [dB]						
		@ Attenuation setting [dB]						
		0.5	1	2	4	8	16	31.5
0.1	-1.21	0.46	-0.01	-0.01	0.00	0.03	0.15	0.18
1	-1.23	0.47	-0.01	-0.01	0.00	0.03	0.15	0.19
10	-1.24	0.47	-0.01	-0.01	0.00	0.03	0.15	0.17
100	-1.27	0.47	-0.01	-0.01	0.00	0.03	0.15	0.17
200	-1.31	0.47	-0.01	-0.01	0.00	0.03	0.15	0.18
400	-1.38	0.47	-0.01	0.00	0.01	0.03	0.15	0.19
500	-1.42	0.47	-0.01	0.00	0.01	0.03	0.15	0.19
700	-1.49	0.47	0.00	0.00	0.01	0.03	0.15	0.20
800	-1.54	0.47	0.00	0.00	0.01	0.03	0.14	0.19
1000	-1.61	0.47	0.00	0.01	0.02	0.02	0.13	0.18
1100	-1.65	0.47	0.00	0.01	0.02	0.02	0.12	0.18
1300	-1.73	0.47	0.00	0.01	0.02	0.01	0.11	0.17
1450	-1.79	0.47	0.00	0.01	0.01	0.00	0.09	0.15
1750	-1.92	0.47	0.00	0.01	0.02	-0.01	0.07	0.10
1900	-1.98	0.48	0.00	0.01	0.02	-0.02	0.05	0.07
2200	-2.11	0.47	0.00	0.01	0.03	-0.03	0.03	0.02
2350	-2.18	0.47	0.00	0.01	0.03	-0.03	0.01	-0.03
2650	-2.29	0.46	-0.01	0.00	0.03	-0.06	-0.06	-0.16
2800	-2.32	0.46	-0.01	-0.01	0.02	-0.10	-0.12	-0.26
3100	-2.39	0.46	-0.03	-0.03	-0.01	-0.19	-0.28	-0.44
3250	-2.41	0.46	-0.04	-0.05	-0.04	-0.26	-0.39	-0.53
3550	-2.44	0.46	-0.06	-0.10	-0.11	-0.43	-0.64	-0.52
3700	-2.45	0.46	-0.07	-0.12	-0.15	-0.52	-0.72	-0.11
3900	-2.48	0.46	-0.08	-0.14	-0.19	-0.63	-0.85	-0.14
4000	-2.52	0.45	-0.08	-0.15	-0.20	-0.69	-0.95	-0.31

Freq. [MHz]	Return Loss In [dB]								Return Loss Out [dB]							
	@ Attenuation setting [dB]								@ Attenuation setting [dB]							
	0	0.5	1	2	4	8	16	31.5	0	0.5	1	2	4	8	16	31.5
0.1	-18.79	-20.34	-21.87	-19.97	-21.00	-24.11	-43.54	-39.26	-18.63	-19.24	-19.43	-24.48	-28.24	-32.18	-28.59	-36.22
1	-18.66	-20.23	-21.75	-19.81	-20.79	-23.77	-41.88	-39.24	-18.51	-19.13	-19.30	-24.34	-27.99	-31.68	-28.14	-36.21
10	-18.54	-20.10	-21.62	-19.72	-20.73	-23.73	-41.56	-39.38	-18.39	-19.02	-19.21	-24.20	-27.86	-31.61	-28.16	-36.19
100	-18.57	-20.12	-21.63	-19.74	-20.74	-23.72	-40.92	-39.47	-18.52	-19.15	-19.33	-24.35	-28.02	-31.76	-28.24	-36.06
200	-18.59	-20.15	-21.66	-19.77	-20.78	-23.77	-40.26	-38.91	-18.49	-19.12	-19.30	-24.30	-27.94	-31.64	-28.17	-36.14
400	-18.58	-20.12	-21.61	-19.73	-20.70	-23.60	-37.38	-38.75	-18.42	-19.03	-19.22	-24.10	-27.58	-30.96	-27.69	-37.19
500	-18.59	-20.12	-21.60	-19.72	-20.68	-23.53	-36.24	-38.34	-18.53	-19.14	-19.32	-24.22	-27.69	-30.98	-27.66	-37.29
700	-18.54	-20.05	-21.51	-19.64	-20.58	-23.35	-34.55	-37.77	-18.51	-19.11	-19.28	-24.10	-27.46	-30.44	-27.27	-37.66
800	-18.53	-20.03	-21.49	-19.63	-20.56	-23.28	-33.81	-37.22	-18.50	-19.10	-19.27	-24.06	-27.37	-30.24	-27.11	-37.93
1000	-18.60	-20.08	-21.51	-19.63	-20.49	-23.06	-31.95	-35.67	-18.49	-19.07	-19.23	-23.92	-27.04	-29.56	-26.56	-38.81
1100	-18.45	-19.92	-21.32	-19.48	-20.32	-22.83	-31.20	-35.37	-18.47	-19.06	-19.21	-23.87	-26.96	-29.35	-26.39	-38.97
1300	-18.21	-19.58	-20.87	-19.05	-19.74	-21.82	-27.94	-32.70	-18.43	-18.96	-19.05	-23.40	-25.97	-27.52	-24.83	-41.98
1450	-18.16	-19.44	-20.63	-18.72	-19.19	-20.87	-25.73	-30.69	-18.39	-18.82	-18.82	-22.80	-24.76	-25.59	-23.12	-38.06
1750	-18.02	-19.10	-20.04	-17.94	-18.07	-19.27	-23.06	-27.09	-18.59	-18.74	-18.53	-21.92	-22.78	-23.15	-21.20	-27.90
1900	-18.03	-18.96	-19.75	-17.70	-17.77	-19.05	-23.03	-26.34	-18.33	-18.34	-18.09	-21.00	-21.52	-22.19	-20.81	-24.79
2200	-16.33	-16.85	-17.27	-16.23	-16.59	-18.37	-22.81	-23.02	-17.11	-16.99	-16.87	-18.66	-19.11	-21.03	-21.57	-20.69
2350	-15.74	-16.13	-16.45	-15.95	-16.61	-18.97	-24.23	-22.36	-16.08	-16.01	-16.02	-17.33	-17.92	-20.53	-22.69	-19.17
2650	-14.58	-14.86	-15.07	-15.20	-16.20	-19.23	-24.51	-20.38	-14.64	-14.69	-14.85	-15.74	-16.50	-19.69	-23.85	-17.56
2800	-14.41	-14.63	-14.78	-15.16	-16.30	-19.58	-24.24	-19.59	-14.20	-14.29	-14.49	-15.28	-16.08	-19.41	-24.03	-17.03
3100	-14.14	-14.30	-14.36	-15.11	-16.45	-19.79	-22.16	-18.09	-13.82	-13.96	-14.21	-14.75	-15.51	-18.80	-22.90	-15.96
3250	-14.11	-14.22	-14.22	-15.13	-16.46	-19.38	-20.38	-17.07	-13.91	-14.08	-14.34	-14.75	-15.46	-18.62	-21.91	-15.59
3550	-14.01	-13.95	-13.79	-14.86	-15.83	-17.18	-16.65	-14.76	-14.85	-15.02	-15.28	-15.26	-15.68	-18.10	-19.33	-14.83
3700	-13.95	-13.81	-13.59	-14.62	-15.33	-15.99	-15.19	-13.77	-15.81	-15.95	-16.20	-15.76	-15.94	-17.75	-18.06	-14.53
3900	-13.72	-13.53	-13.24	-14.13	-14.52	-14.60	-13.64	-12.57	-17.04	-17.14	-17.36	-16.18	-15.99	-16.83	-16.21	-14.05
4000	-13.77	-13.60	-13.30	-14.15	-14.51	-14.49	-13.43	-12.37	-17.39	-17.45	-17.64	-16.09	-15.76	-16.18	-15.31	-13.73



TYPICAL PERFORMANCE CURVES (AT 25°C)

Attenuation Accuracy relative to Insertion Loss vs. Frequency

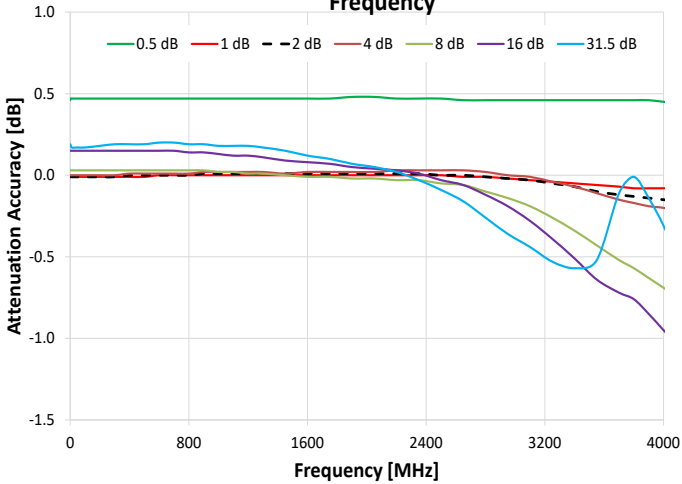

Attenuation relative to Insertion Loss vs. Frequency

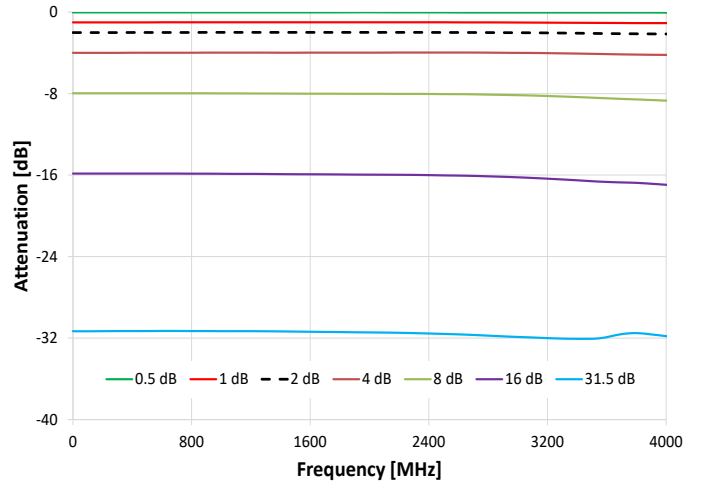

Insertion Loss vs. Frequency

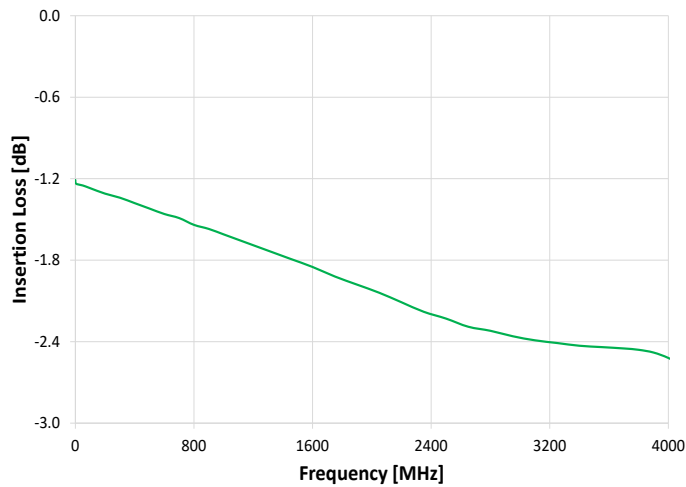

R. Loss In vs. Frequency over Attenuation settings

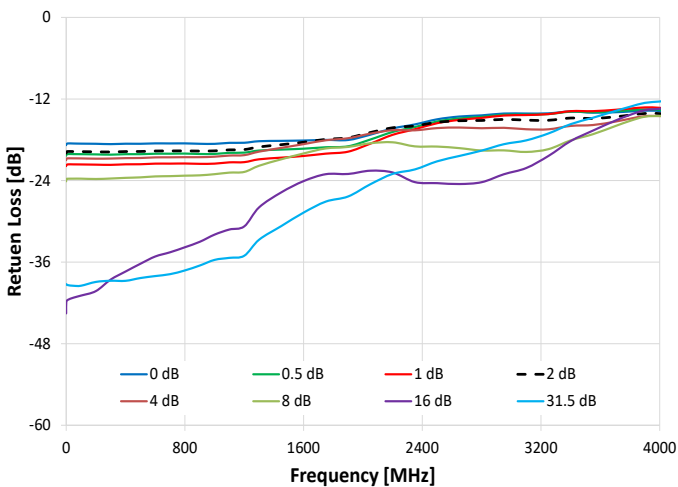

R. Loss Out vs. Frequency over Attenuation settings

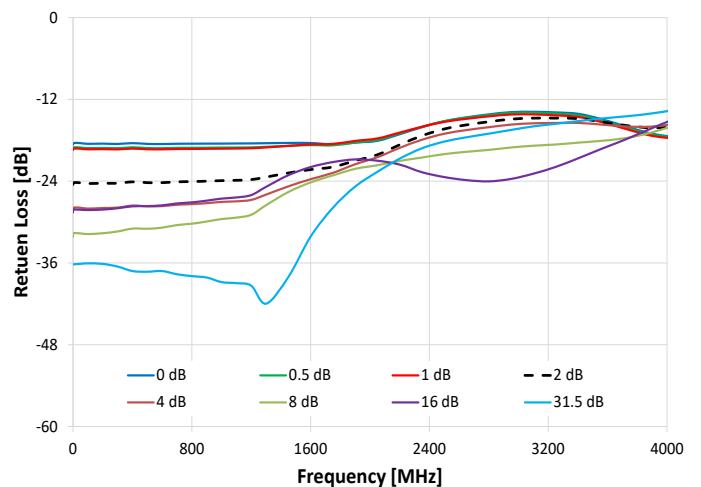



ORDERING INFORMATION

Model	Description
ZX76-31R5A-SPS+	Digital attenuator - Serial interface, Single Voltage (Positive)

Recommended Accessories	Part No.	Description
	ZX76-WS+	4.9 ft. (1.5M) Control Cable

ADDITIONAL DETAILED TECHNICAL INFORMATION

Performance Data	Data Table
	Swept Graphs
	S-Parameter (S2P Files) Data Set (.zip.file)
Case Style	HK1172
Environmental Rating	ENV28T14

Additional information is available on our dash board. To access this information [click here](#)

- NOTES**
- A. Performance and quality attributes and conditions not expressly stated in this specification document are intended to be excluded and do not form a part of this specification document.
 - B. Electrical specifications and performance data contained in this specification document are based on Mini-Circuit's applicable established test performance criteria and measurement instructions.
 - C. The parts covered by this specification document are subject to Mini-Circuits standard limited warranty and terms and conditions (collectively, "Standard Terms"); Purchasers of this part are entitled to the rights and benefits contained therein. For a full statement of the standard. Terms and the exclusive rights and remedies thereunder, please visit Mini-Circuits' website at www.minicircuits.com/MCLStore/terms.jsp

Digital Step Attenuator

ZX76-31R5A-SP+

Typical Performance Data

TEST CONDITIONS: INPUT POWER=0 dBm, Vdd=+3V, TEMPERATURE=-40°C

FREQUENCY (MHz)	STEP ATTENUATION* AT TTL CONTROL STATE (dB)							
	000000	000001	000010	000100	001000	010000	100000	111111
	THRU LOSS	0.5 dB	1.0 dB	2.0 dB	4.0 dB	8.0 dB	16 dB	31.5 dB
0.1	1.03	0.55	1.05	2.07	4.10	8.12	16.06	31.62
0.3	1.03	0.55	1.06	2.07	4.10	8.11	16.06	31.62
0.5	1.05	0.54	1.05	2.06	4.09	8.10	16.03	31.60
1	1.07	0.54	1.05	2.06	4.08	8.08	16.02	31.59
5	1.06	0.54	1.05	2.06	4.08	8.08	16.01	31.58
10	1.06	0.54	1.05	2.06	4.08	8.08	16.01	31.58
50	1.06	0.54	1.04	2.06	4.08	8.07	16.00	31.57
100	1.07	0.54	1.04	2.06	4.08	8.07	16.00	31.57
200	1.11	0.54	1.05	2.06	4.08	8.08	16.01	31.58
300	1.10	0.54	1.04	2.05	4.07	8.07	15.99	31.55
400	1.12	0.54	1.04	2.06	4.08	8.07	16.00	31.56
500	1.13	0.54	1.05	2.06	4.08	8.08	16.01	31.56
600	1.12	0.54	1.04	2.06	4.08	8.07	16.00	31.55
700	1.14	0.54	1.05	2.06	4.08	8.09	16.02	31.57
800	1.13	0.54	1.05	2.06	4.08	8.08	16.01	31.56
900	1.14	0.54	1.05	2.06	4.08	8.08	16.02	31.56
1000	1.16	0.54	1.05	2.06	4.08	8.09	16.02	31.57
1100	1.15	0.54	1.04	2.06	4.08	8.08	16.01	31.54
1200	1.19	0.54	1.05	2.06	4.08	8.09	16.03	31.56
1300	1.24	0.54	1.04	2.05	4.07	8.09	16.02	31.54
1400	1.31	0.53	1.04	2.04	4.06	8.08	16.01	31.51
1500	1.36	0.53	1.03	2.04	4.06	8.08	16.02	31.49
1600	1.43	0.53	1.03	2.04	4.05	8.09	16.02	31.45
1700	1.49	0.53	1.03	2.03	4.05	8.09	16.03	31.41
1800	1.56	0.53	1.02	2.03	4.04	8.10	16.04	31.36
1900	1.64	0.53	1.02	2.02	4.04	8.11	16.05	31.34
2000	1.70	0.53	1.02	2.02	4.04	8.13	16.08	31.36
2100	1.76	0.53	1.02	2.02	4.04	8.15	16.12	31.37
2200	1.82	0.53	1.02	2.03	4.05	8.17	16.16	31.38
2300	1.90	0.53	1.02	2.03	4.05	8.20	16.19	31.36
2400	1.97	0.53	1.02	2.03	4.06	8.23	16.23	31.35
2500	2.00	0.53	1.03	2.04	4.06	8.25	16.25	31.33
2600	2.03	0.53	1.03	2.04	4.07	8.27	16.27	31.31
2700	2.06	0.54	1.03	2.04	4.08	8.29	16.29	31.29
2800	2.09	0.54	1.04	2.05	4.08	8.31	16.32	31.28
2900	2.13	0.54	1.04	2.06	4.10	8.34	16.37	31.28
3000	2.16	0.54	1.04	2.06	4.11	8.38	16.41	31.25
3200	2.25	0.55	1.05	2.08	4.13	8.43	16.40	30.55
3400	2.31	0.56	1.06	2.09	4.15	8.48	16.43	30.57
3600	2.42	0.56	1.07	2.12	4.19	8.59	16.62	31.13
3800	2.62	0.56	1.07	2.14	4.25	8.74	16.93	32.26
4000	2.84	0.57	1.09	2.19	4.32	8.92	17.32	32.93
4200	2.76	0.59	1.12	2.24	4.39	9.08	17.46	31.31
4400	2.61	0.60	1.14	2.27	4.44	9.22	17.60	30.83
4600	2.61	0.60	1.14	2.27	4.46	9.34	17.79	31.16
4800	2.71	0.60	1.14	2.25	4.45	9.41	17.90	31.58
5000	2.93	0.59	1.12	2.24	4.44	9.48	18.01	31.89

* Step Attenuation above Thru Loss (TTL Logic 00000).

Notes

- A. Performance and quality attributes and conditions not expressly stated in this specification document are intended to be excluded and do not form a part of this specification document.
- B. Electrical specifications and performance data contained in this specification document are based on Mini-Circuits' applicable established test performance criteria and measurement instructions.
- C. The parts covered by this specification document are subject to Mini-Circuits' standard limited warranty and terms and conditions (collectively, "Standard Terms"). Purchasers of this part are entitled to the rights and benefits contained therein. For a full statement of the Standard Terms and the exclusive rights and remedies thereunder, please visit Mini-Circuits' website at www.minicircuits.com/MC_Store/terms.jsp



Digital Step Attenuator

ZX76-31R5A-SP+

Typical Performance Data

TEST CONDITIONS: INPUT POWER=0 dBm, Vdd=+3V, TEMPERATURE=-40°C

FREQUENCY (MHz)	INPUT RETURN LOSS AT TTL CONTROL STATE (dB)							
	000000 0 dB	000001 0.5 dB	000010 1.0 dB	000100 2.0 dB	001000 4.0 dB	010000 8.0 dB	100000 16 dB	111111 31.5 dB
0.1	19.72	22.01	24.49	22.83	25.72	36.93	26.19	23.61
0.3	19.72	22.00	24.47	22.83	25.72	36.79	26.26	23.62
0.5	19.71	21.99	24.46	22.74	25.53	35.85	26.45	23.63
1	19.57	21.86	24.30	22.57	25.30	35.29	26.53	23.63
5	19.45	21.72	24.13	22.44	25.17	35.00	26.60	23.69
10	19.44	21.70	24.11	22.42	25.14	34.90	26.63	23.71
50	19.47	21.71	24.09	22.39	25.07	34.57	26.74	23.80
100	19.49	21.71	24.08	22.32	24.95	34.04	26.95	23.95
200	19.51	21.68	23.98	22.14	24.63	32.91	27.45	24.35
300	19.37	21.49	23.72	21.90	24.30	32.08	28.07	24.78
400	19.12	21.20	23.36	21.71	24.11	31.84	28.30	24.93
500	18.97	21.02	23.16	21.66	24.07	31.83	28.36	24.95
600	18.85	20.91	23.04	21.70	24.17	32.25	28.09	24.75
700	18.95	21.08	23.30	21.98	24.57	33.40	27.41	24.29
800	19.11	21.30	23.60	22.21	24.88	34.22	27.03	24.04
900	19.41	21.67	24.07	22.57	25.33	35.37	26.54	23.73
1000	19.70	22.02	24.51	22.87	25.67	35.61	26.13	23.51
1100	19.66	21.97	24.43	22.77	25.51	34.55	26.12	23.59
1200	19.59	21.88	24.31	22.72	25.41	33.76	25.94	23.53
1300	19.23	21.34	23.51	21.63	23.86	29.50	26.63	24.63
1400	19.04	20.98	22.94	21.32	23.16	27.87	27.66	26.12
1500	18.83	20.72	22.58	20.90	22.65	27.36	28.76	27.41
1600	18.83	20.67	22.48	21.05	22.71	27.50	29.41	28.11
1700	19.13	21.00	22.83	21.17	22.75	27.26	28.63	28.25
1800	18.95	20.71	22.41	20.59	21.94	26.00	29.48	30.60
1900	19.09	20.77	22.35	20.17	21.36	25.41	31.68	33.44
2000	18.87	20.36	21.75	19.60	20.75	24.90	35.73	34.16
2100	18.68	19.99	21.18	19.55	20.68	25.06	40.58	31.55
2200	18.54	19.69	20.68	19.11	20.24	24.68	52.46	29.48
2300	18.21	19.10	19.83	18.46	19.59	23.98	39.88	26.61
2400	17.28	17.94	18.47	17.70	18.91	23.20	30.99	23.53
2500	16.79	17.37	17.84	17.45	18.73	23.01	28.61	22.38
2600	16.46	16.98	17.39	17.27	18.59	22.80	26.80	21.42
2700	16.18	16.63	16.98	17.03	18.38	22.39	25.02	20.41
2800	15.86	16.27	16.58	16.75	18.12	21.86	23.43	19.47
2900	15.59	15.97	16.22	16.56	17.93	21.35	22.07	18.63
3000	15.38	15.71	15.92	16.35	17.70	20.78	20.99	17.94
3200	14.95	15.16	15.28	15.84	17.07	19.29	18.82	16.47
3400	14.48	14.56	14.53	15.40	16.32	17.41	16.39	14.72
3600	14.48	14.38	14.19	14.77	15.25	15.41	14.25	13.09
3800	14.98	14.63	14.26	14.64	14.60	13.93	12.60	11.83
4000	15.01	14.63	14.20	14.50	14.28	13.36	11.93	11.26
4200	15.87	15.52	14.96	15.04	14.72	13.49	11.75	11.02
4400	18.22	17.60	16.59	16.65	15.78	13.68	11.50	10.78
4600	22.13	20.17	18.22	18.59	16.52	13.37	10.96	10.38
4800	26.23	21.32	18.72	19.33	16.30	12.64	10.26	9.89
5000	23.65	20.01	18.03	18.93	15.89	12.16	9.85	9.68

Notes

- A. Performance and quality attributes and conditions not expressly stated in this specification document are intended to be excluded and do not form a part of this specification document.
- B. Electrical specifications and performance data contained in this specification document are based on Mini-Circuit's applicable established test performance criteria and measurement instructions.
- C. The parts covered by this specification document are subject to Mini-Circuit's standard limited warranty and terms and conditions (collectively, "Standard Terms"); Purchasers of this part are entitled to the rights and benefits contained therein. For a full statement of the Standard Terms and the exclusive rights and remedies thereunder, please visit Mini-Circuit's website at www.minicircuits.com/MC_Store/terms.jsp



Digital Step Attenuator

ZX76-31R5A-SP+

Typical Performance Data

TEST CONDITIONS: INPUT POWER=0 dBm, Vdd=+3V, TEMPERATURE=-40°C

FREQUENCY (MHz)	OUTPUT RETURN LOSS AT TTL CONTROL STATE (dB)							
	000000 0 dB	000001 0.5 dB	000010 1.0 dB	000100 2.0 dB	001000 4.0 dB	010000 8.0 dB	100000 16 dB	111111 31.5 dB
0.1	19.55	20.70	21.33	30.07	57.68	32.48	34.36	23.26
0.3	19.56	20.70	21.34	30.04	56.79	32.56	34.44	23.26
0.5	19.45	20.58	21.22	29.77	51.90	33.09	35.32	23.28
1	19.39	20.54	21.15	29.70	50.99	33.25	35.69	23.28
5	19.23	20.37	20.98	29.38	48.27	33.46	35.81	23.32
10	19.21	20.34	20.95	29.33	47.86	33.51	35.87	23.34
50	19.17	20.29	20.89	29.26	46.51	33.66	36.07	23.41
100	19.17	20.27	20.85	29.28	45.33	33.93	36.49	23.55
200	19.00	20.06	20.61	28.90	43.00	35.02	38.10	23.93
300	19.13	20.16	20.69	29.10	43.62	35.50	39.05	24.10
400	19.25	20.29	20.83	29.24	44.08	35.12	38.53	23.99
500	19.55	20.62	21.17	29.69	45.00	34.45	37.64	23.82
600	19.74	20.85	21.44	29.90	46.18	33.83	36.50	23.61
700	19.84	20.99	21.60	29.93	49.44	33.52	35.65	23.50
800	19.69	20.85	21.47	29.46	47.29	33.86	35.60	23.61
900	19.52	20.66	21.28	29.10	45.01	34.06	35.39	23.69
1000	19.31	20.43	21.04	28.60	41.89	34.49	35.42	23.90
1100	19.13	20.24	20.84	28.19	40.42	35.12	35.87	24.09
1200	19.19	20.30	20.90	28.31	40.75	34.89	35.58	24.05
1300	19.08	20.13	20.67	28.12	36.64	33.59	32.89	24.52
1400	19.10	20.04	20.48	27.10	34.38	38.26	34.30	26.73
1500	19.70	20.59	20.96	28.37	36.69	40.82	35.15	26.61
1600	19.91	20.74	21.03	27.58	34.19	41.96	33.63	27.81
1700	19.94	20.71	20.95	27.15	32.78	42.66	33.34	28.53
1800	20.08	20.71	20.86	26.85	31.03	40.33	33.26	29.37
1900	19.82	20.32	20.40	26.00	28.97	36.34	32.89	29.40
2000	19.95	20.33	20.35	25.72	27.96	35.27	34.93	27.73
2100	19.67	19.92	19.93	24.31	26.00	31.91	34.03	26.81
2200	19.14	19.30	19.33	22.94	24.25	29.40	34.34	25.06
2300	18.07	18.17	18.22	21.17	22.21	26.52	32.45	22.96
2400	17.12	17.19	17.29	19.64	20.52	24.28	29.91	20.90
2500	16.65	16.72	16.86	19.05	19.91	23.51	28.72	20.18
2600	16.24	16.33	16.50	18.46	19.31	22.76	27.43	19.53
2700	15.89	15.98	16.16	17.78	18.59	21.79	25.80	18.75
2800	15.54	15.64	15.83	17.15	17.93	20.87	24.21	17.97
2900	15.31	15.43	15.63	16.79	17.50	20.23	22.98	17.35
3000	15.01	15.15	15.37	16.44	17.09	19.60	21.88	16.78
3200	14.54	14.71	14.95	15.82	16.31	18.24	19.55	15.55
3400	14.49	14.66	14.88	15.65	15.94	17.35	17.93	14.74
3600	15.48	15.62	15.79	15.86	15.75	16.37	16.23	13.86
3800	17.74	17.78	17.86	16.84	16.06	15.67	14.90	13.30
4000	19.53	19.27	19.18	16.92	15.67	14.67	13.65	12.75
4200	19.97	19.47	19.17	16.09	14.75	13.49	12.37	11.94
4400	21.81	20.97	20.37	16.27	14.62	12.95	11.66	11.44
4600	25.72	23.70	22.45	16.71	14.67	12.53	11.10	11.09
4800	29.10	25.77	24.07	16.88	14.69	12.20	10.67	10.90
5000	23.64	22.55	21.82	16.12	14.14	11.54	10.02	10.50

Notes

- A. Performance and quality attributes and conditions not expressly stated in this specification document are intended to be excluded and do not form a part of this specification document.
- B. Electrical specifications and performance data contained in this specification document are based on Mini-Circuits' applicable established test performance criteria and measurement instructions.
- C. The parts covered by this specification document are subject to Mini-Circuits' standard limited warranty and terms and conditions (collectively, "Standard Terms"). Purchasers of this part are entitled to the rights and benefits contained therein. For a full statement of the Standard Terms and the exclusive rights and remedies thereunder, please visit Mini-Circuits' website at www.minicircuits.com/MC_Store/terms.jsp



Digital Step Attenuator

ZX76-31R5A-SP+

Typical Performance Data

TEST CONDITIONS: INPUT POWER=0 dBm, Vdd=+3V, TEMPERATURE=+25°C

FREQUENCY (MHz)	STEP ATTENUATION* AT TTL CONTROL STATE							
	(dB)							
	000000 THRU LOSS	000001 0.5 dB	000010 1.0 dB	000100 2.0 dB	001000 4.0 dB	010000 8.0 dB	100000 16 dB	111111 31.5 dB
0.1	1.21	0.52	1.01	2.01	4.00	7.97	15.85	31.32
0.3	1.22	0.52	1.01	2.01	4.00	7.97	15.85	31.31
0.5	1.22	0.51	1.01	2.01	4.00	7.97	15.85	31.32
1	1.23	0.51	1.01	2.01	4.00	7.97	15.85	31.31
5	1.23	0.52	1.01	2.01	4.00	7.97	15.85	31.32
10	1.24	0.52	1.01	2.01	4.00	7.97	15.85	31.33
50	1.25	0.52	1.01	2.01	4.00	7.97	15.85	31.33
100	1.27	0.52	1.01	2.01	4.00	7.97	15.85	31.33
200	1.31	0.52	1.01	2.01	4.00	7.97	15.85	31.32
300	1.34	0.51	1.01	2.01	4.00	7.97	15.85	31.31
400	1.38	0.51	1.01	2.00	3.99	7.97	15.85	31.31
500	1.42	0.51	1.01	2.00	3.99	7.97	15.85	31.31
600	1.46	0.51	1.00	2.00	3.99	7.97	15.85	31.30
700	1.49	0.51	1.00	2.00	3.99	7.97	15.85	31.30
800	1.54	0.51	1.00	2.00	3.99	7.97	15.86	31.31
900	1.57	0.51	1.00	1.99	3.98	7.97	15.86	31.31
1000	1.61	0.51	1.00	1.99	3.98	7.98	15.87	31.32
1100	1.65	0.51	1.00	1.99	3.98	7.98	15.88	31.32
1200	1.69	0.51	1.00	1.99	3.98	7.99	15.88	31.32
1300	1.73	0.51	1.00	1.99	3.98	7.99	15.89	31.33
1400	1.77	0.51	1.00	1.99	3.98	8.00	15.90	31.34
1500	1.81	0.51	1.00	1.99	3.98	8.00	15.91	31.36
1600	1.85	0.51	1.00	1.99	3.98	8.01	15.92	31.38
1700	1.89	0.51	1.00	1.99	3.98	8.01	15.93	31.40
1800	1.93	0.51	1.00	1.99	3.98	8.02	15.94	31.42
1900	1.98	0.51	1.00	1.99	3.98	8.02	15.95	31.43
2000	2.02	0.51	1.00	1.99	3.98	8.02	15.95	31.45
2100	2.07	0.51	1.00	1.99	3.98	8.02	15.96	31.46
2200	2.11	0.51	1.00	1.99	3.97	8.03	15.97	31.48
2300	2.15	0.51	1.00	1.99	3.97	8.03	15.98	31.51
2400	2.19	0.51	1.00	2.00	3.97	8.04	16.00	31.55
2500	2.23	0.51	1.00	2.00	3.97	8.05	16.03	31.59
2600	2.26	0.52	1.01	2.00	3.98	8.06	16.05	31.64
2700	2.29	0.52	1.01	2.00	3.98	8.08	16.08	31.70
2800	2.32	0.52	1.01	2.01	3.98	8.10	16.12	31.76
2900	2.35	0.52	1.02	2.01	3.99	8.12	16.17	31.83
3000	2.37	0.53	1.02	2.02	4.00	8.15	16.22	31.89
3200	2.41	0.53	1.03	2.04	4.03	8.23	16.35	31.99
3400	2.43	0.54	1.05	2.07	4.07	8.34	16.51	32.07
3600	2.44	0.55	1.07	2.10	4.13	8.46	16.68	31.93
3800	2.46	0.56	1.08	2.13	4.17	8.57	16.76	31.51
4000	2.52	0.56	1.08	2.15	4.20	8.69	16.95	31.81
4200	2.67	0.56	1.08	2.16	4.23	8.81	17.17	32.37
4400	2.93	0.56	1.07	2.16	4.25	8.93	17.46	33.47
4600	3.14	0.56	1.08	2.18	4.28	9.07	17.78	33.66
4800	3.12	0.57	1.09	2.18	4.29	9.17	17.95	32.29
5000	3.11	0.56	1.07	2.14	4.24	9.22	18.09	31.86

* Step Attenuation above Thru Loss (TTL Logic 00000).

Notes

- A. Performance and quality attributes and conditions not expressly stated in this specification document are intended to be excluded and do not form a part of this specification document.
- B. Electrical specifications and performance data contained in this specification document are based on Mini-Circuits' applicable established test performance criteria and measurement instructions.
- C. The parts covered by this specification document are subject to Mini-Circuits' standard limited warranty and terms and conditions (collectively, "Standard Terms"); Purchasers of this part are entitled to the rights and benefits contained therein. For a full statement of the Standard Terms and the exclusive rights and remedies thereunder, please visit Mini-Circuits' website at www.minicircuits.com/MC_Store/terms.jsp



Digital Step Attenuator

ZX76-31R5A-SP+

Typical Performance Data

TEST CONDITIONS: INPUT POWER=0 dBm, Vdd=+3V, TEMPERATURE=+25°C

FREQUENCY (MHz)	INPUT RETURN LOSS AT TTL CONTROL STATE (dB)							
	000000 0 dB	000001 0.5 dB	000010 1.0 dB	000100 2.0 dB	001000 4.0 dB	010000 8.0 dB	100000 16 dB	111111 31.5 dB
0.1	18.79	20.34	21.87	19.97	21.00	24.11	43.54	39.26
0.3	18.77	20.32	21.84	19.96	20.99	24.08	43.26	39.23
0.5	18.76	20.31	21.83	19.90	20.88	23.85	42.07	39.31
1	18.66	20.23	21.75	19.81	20.79	23.77	41.88	39.24
5	18.56	20.12	21.64	19.74	20.75	23.75	41.62	39.31
10	18.54	20.10	21.62	19.72	20.73	23.73	41.56	39.38
50	18.55	20.11	21.62	19.73	20.73	23.72	41.22	39.48
100	18.57	20.12	21.63	19.74	20.74	23.72	40.92	39.47
200	18.59	20.15	21.66	19.77	20.78	23.77	40.26	38.91
300	18.64	20.19	21.69	19.79	20.76	23.70	38.56	38.74
400	18.58	20.12	21.61	19.73	20.70	23.60	37.38	38.75
500	18.59	20.12	21.60	19.72	20.68	23.53	36.24	38.34
600	18.53	20.05	21.51	19.65	20.59	23.39	35.17	38.05
700	18.54	20.05	21.51	19.64	20.58	23.35	34.55	37.77
800	18.53	20.03	21.49	19.63	20.56	23.28	33.81	37.22
900	18.59	20.09	21.54	19.66	20.56	23.23	33.01	36.50
1000	18.60	20.08	21.51	19.63	20.49	23.06	31.95	35.67
1100	18.45	19.92	21.32	19.48	20.32	22.83	31.20	35.37
1200	18.44	19.89	21.29	19.44	20.26	22.73	30.74	35.06
1300	18.21	19.58	20.87	19.05	19.74	21.82	27.94	32.70
1400	18.09	19.40	20.60	18.75	19.30	21.07	26.22	31.08
1500	18.15	19.41	20.56	18.61	19.03	20.58	25.07	29.87
1600	18.11	19.31	20.38	18.36	18.64	20.01	24.08	28.71
1700	18.16	19.28	20.28	18.17	18.34	19.58	23.42	27.78
1800	17.98	19.01	19.90	17.82	17.94	19.18	23.07	26.90
1900	18.03	18.96	19.75	17.70	17.77	19.05	23.03	26.34
2000	17.60	18.38	19.05	17.24	17.36	18.73	22.78	25.25
2100	16.90	17.54	18.08	16.65	16.86	18.38	22.51	23.93
2200	16.33	16.85	17.27	16.23	16.59	18.37	22.81	23.02
2300	15.93	16.36	16.71	16.03	16.57	18.71	23.65	22.58
2400	15.47	15.84	16.12	15.79	16.55	19.11	24.59	22.02
2500	14.99	15.31	15.56	15.43	16.28	19.00	24.38	21.17
2600	14.73	15.02	15.24	15.28	16.22	19.14	24.49	20.66
2700	14.46	14.72	14.91	15.11	16.15	19.22	24.32	20.06
2800	14.41	14.63	14.78	15.16	16.30	19.58	24.24	19.59
2900	14.20	14.40	14.52	15.04	16.25	19.57	23.44	18.92
3000	14.15	14.32	14.40	15.05	16.33	19.67	22.72	18.41
3200	14.14	14.26	14.27	15.15	16.50	19.59	20.95	17.40
3400	13.84	13.87	13.79	14.80	15.96	18.09	18.19	15.70
3600	13.76	13.70	13.54	14.57	15.47	16.70	16.21	14.43
3800	13.84	13.66	13.41	14.37	14.90	15.22	14.34	13.14
4000	13.77	13.60	13.30	14.15	14.51	14.49	13.43	12.37
4200	14.90	14.63	14.12	15.01	15.08	14.38	12.78	11.82
4400	17.09	16.42	15.50	16.56	16.02	14.28	12.22	11.40
4600	21.93	19.84	17.97	19.40	17.50	14.24	11.79	11.25
4800	24.89	20.88	18.59	19.88	17.09	13.37	11.02	10.74
5000	22.12	19.52	17.97	18.84	16.24	12.62	10.42	10.39

Notes

- A. Performance and quality attributes and conditions not expressly stated in this specification document are intended to be excluded and do not form a part of this specification document.
- B. Electrical specifications and performance data contained in this specification document are based on Mini-Circuits' applicable established test performance criteria and measurement instructions.
- C. The parts covered by this specification document are subject to Mini-Circuits' standard limited warranty and terms and conditions (collectively, "Standard Terms"); Purchasers of this part are entitled to the rights and benefits contained therein. For a full statement of the Standard Terms and the exclusive rights and remedies thereunder, please visit Mini-Circuits' website at www.minicircuits.com/MC_Store/terms.jsp



Digital Step Attenuator

ZX76-31R5A-SP+

Typical Performance Data

TEST CONDITIONS: INPUT POWER=0 dBm, Vdd=+3V, TEMPERATURE=+25°C

FREQUENCY (MHz)	OUTPUT RETURN LOSS AT TTL CONTROL STATE (dB)							
	000000 0 dB	000001 0.5 dB	000010 1.0 dB	000100 2.0 dB	001000 4.0 dB	010000 8.0 dB	100000 16 dB	111111 31.5 dB
0.1	18.63	19.24	19.43	24.48	28.24	32.18	28.59	36.22
0.3	18.62	19.23	19.42	24.47	28.22	32.16	28.58	36.17
0.5	18.52	19.13	19.32	24.32	27.99	31.69	28.19	36.20
1	18.51	19.13	19.30	24.34	27.99	31.68	28.14	36.21
5	18.41	19.03	19.22	24.21	27.88	31.63	28.17	36.18
10	18.39	19.02	19.21	24.20	27.86	31.61	28.16	36.19
50	18.42	19.06	19.24	24.24	27.90	31.66	28.19	36.13
100	18.52	19.15	19.33	24.35	28.02	31.76	28.24	36.06
200	18.49	19.12	19.30	24.30	27.94	31.64	28.17	36.14
300	18.54	19.16	19.34	24.31	27.88	31.38	27.97	36.53
400	18.42	19.03	19.22	24.10	27.58	30.96	27.69	37.19
500	18.53	19.14	19.32	24.22	27.69	30.98	27.66	37.29
600	18.55	19.16	19.33	24.22	27.66	30.82	27.55	37.19
700	18.51	19.11	19.28	24.10	27.46	30.44	27.27	37.66
800	18.50	19.10	19.27	24.06	27.37	30.24	27.11	37.93
900	18.49	19.09	19.25	24.00	27.23	29.92	26.86	38.14
1000	18.49	19.07	19.23	23.92	27.04	29.56	26.56	38.81
1100	18.47	19.06	19.21	23.87	26.96	29.35	26.39	38.97
1200	18.46	19.04	19.17	23.77	26.75	28.93	26.04	39.34
1300	18.43	18.96	19.05	23.40	25.97	27.52	24.83	41.98
1400	18.39	18.85	18.89	22.97	25.11	26.12	23.59	40.09
1500	18.34	18.74	18.72	22.59	24.36	25.04	22.65	35.86
1600	18.40	18.71	18.61	22.30	23.71	24.18	21.93	32.13
1700	18.46	18.67	18.51	22.00	23.04	23.42	21.38	29.15
1800	18.58	18.67	18.45	21.69	22.41	22.87	21.08	26.76
1900	18.33	18.34	18.09	21.00	21.52	22.19	20.81	24.79
2000	18.20	18.12	17.86	20.45	20.84	21.81	20.87	23.30
2100	17.83	17.70	17.49	19.67	20.05	21.47	21.17	21.95
2200	17.11	16.99	16.87	18.66	19.11	21.03	21.57	20.69
2300	16.41	16.32	16.28	17.75	18.29	20.67	22.22	19.64
2400	15.72	15.67	15.72	16.89	17.52	20.32	23.12	18.67
2500	15.20	15.20	15.30	16.34	17.04	20.03	23.40	18.19
2600	14.80	14.83	14.97	15.91	16.67	19.79	23.69	17.77
2700	14.49	14.54	14.72	15.57	16.35	19.60	23.93	17.40
2800	14.20	14.29	14.49	15.28	16.08	19.41	24.03	17.03
2900	14.01	14.12	14.34	15.05	15.85	19.21	23.89	16.66
3000	13.84	13.97	14.21	14.84	15.64	18.99	23.47	16.30
3200	13.83	13.99	14.25	14.70	15.43	18.63	22.22	15.67
3400	14.11	14.30	14.57	14.82	15.45	18.35	20.66	15.19
3600	15.04	15.21	15.47	15.34	15.71	17.97	18.91	14.72
3800	16.46	16.58	16.82	16.02	16.03	17.36	17.14	14.32
4000	17.39	17.45	17.64	16.09	15.76	16.18	15.31	13.73
4200	18.27	18.22	18.28	16.04	15.41	15.13	13.89	13.06
4400	20.26	20.04	19.89	16.55	15.52	14.51	12.95	12.59
4600	25.03	23.82	22.99	17.41	15.83	13.96	12.16	12.26
4800	27.89	25.53	24.21	17.70	15.80	13.28	11.37	11.94
5000	22.61	21.91	21.47	17.10	15.42	12.68	10.79	11.71

Notes

- A. Performance and quality attributes and conditions not expressly stated in this specification document are intended to be excluded and do not form a part of this specification document.
- B. Electrical specifications and performance data contained in this specification document are based on Mini-Circuits' applicable established test performance criteria and measurement instructions.
- C. The parts covered by this specification document are subject to Mini-Circuits' standard limited warranty and terms and conditions (collectively, "Standard Terms"); Purchasers of this part are entitled to the rights and benefits contained therein. For a full statement of the Standard Terms and the exclusive rights and remedies thereunder, please visit Mini-Circuits' website at www.minicircuits.com/MC_Store/terms.jsp



Digital Step Attenuator

ZX76-31R5A-SP+

Typical Performance Data

TEST CONDITIONS: INPUT POWER=0 dBm, Vdd=+3V, TEMPERATURE=+85°C

FREQUENCY (MHz)	STEP ATTENUATION* AT TTL CONTROL STATE							
	(dB)							
	000000 THRU LOSS	000001 0.5 dB	000010 1.0 dB	000100 2.0 dB	001000 4.0 dB	010000 8.0 dB	100000 16 dB	111111 31.5 dB
0.1	1.22	0.52	1.02	2.01	4.00	7.92	15.89	31.25
0.3	1.23	0.52	1.02	2.01	4.00	7.92	15.89	31.24
0.5	1.25	0.52	1.02	2.01	3.99	7.90	15.87	31.22
1	1.27	0.52	1.02	2.01	3.99	7.89	15.86	31.21
5	1.26	0.52	1.02	2.01	3.99	7.90	15.86	31.22
10	1.26	0.52	1.02	2.01	3.99	7.90	15.86	31.22
50	1.26	0.52	1.02	2.01	3.99	7.90	15.86	31.22
100	1.26	0.52	1.02	2.01	3.99	7.90	15.86	31.22
200	1.30	0.52	1.02	2.01	3.99	7.90	15.87	31.23
300	1.29	0.52	1.02	2.01	3.99	7.90	15.86	31.22
400	1.31	0.52	1.02	2.01	4.00	7.90	15.87	31.23
500	1.34	0.52	1.02	2.01	3.99	7.90	15.87	31.23
600	1.34	0.52	1.02	2.01	3.99	7.90	15.86	31.21
700	1.38	0.52	1.02	2.01	3.99	7.90	15.87	31.22
800	1.38	0.52	1.02	2.01	3.99	7.90	15.86	31.20
900	1.41	0.52	1.02	2.01	3.99	7.90	15.86	31.20
1000	1.43	0.52	1.02	2.01	3.99	7.90	15.87	31.21
1100	1.43	0.52	1.02	2.01	3.99	7.90	15.86	31.19
1200	1.47	0.52	1.02	2.01	3.99	7.90	15.87	31.21
1300	1.56	0.52	1.02	2.01	3.99	7.91	15.88	31.21
1400	1.65	0.51	1.02	2.01	3.99	7.92	15.90	31.22
1500	1.74	0.51	1.02	2.01	3.99	7.93	15.92	31.23
1600	1.83	0.51	1.02	2.01	4.00	7.95	15.94	31.24
1700	1.92	0.51	1.02	2.01	4.00	7.96	15.96	31.25
1800	2.01	0.51	1.02	2.02	4.01	7.98	15.99	31.26
1900	2.10	0.51	1.02	2.02	4.01	8.00	16.02	31.29
2000	2.20	0.52	1.02	2.02	4.01	8.02	16.05	31.35
2100	2.29	0.52	1.02	2.03	4.02	8.04	16.09	31.42
2200	2.38	0.52	1.03	2.03	4.02	8.06	16.13	31.51
2300	2.47	0.52	1.03	2.04	4.02	8.09	16.17	31.60
2400	2.55	0.52	1.03	2.04	4.02	8.11	16.22	31.67
2500	2.59	0.53	1.03	2.04	4.02	8.12	16.24	31.68
2600	2.64	0.53	1.03	2.04	4.03	8.14	16.27	31.69
2700	2.68	0.53	1.04	2.05	4.03	8.15	16.29	31.70
2800	2.72	0.53	1.04	2.05	4.03	8.17	16.32	31.69
2900	2.77	0.53	1.04	2.05	4.03	8.19	16.35	31.65
3000	2.82	0.53	1.04	2.06	4.03	8.21	16.36	31.46
3200	2.89	0.54	1.04	2.07	4.04	8.24	16.36	31.13
3400	3.00	0.54	1.04	2.09	4.05	8.30	16.45	31.49
3600	3.17	0.54	1.05	2.09	4.07	8.39	16.64	32.21
3800	3.38	0.54	1.06	2.12	4.13	8.53	16.96	33.25
4000	3.47	0.55	1.08	2.16	4.18	8.68	17.21	32.47
4200	3.36	0.56	1.11	2.20	4.24	8.83	17.40	31.51
4400	3.28	0.58	1.13	2.23	4.30	9.01	17.71	31.69
4600	3.32	0.58	1.13	2.25	4.34	9.18	18.01	32.29
4800	3.49	0.58	1.12	2.25	4.34	9.30	18.24	32.82
5000	3.74	0.57	1.10	2.23	4.33	9.40	18.41	32.97

* Step Attenuation above Thru Loss (TTL Logic 00000).

Notes

- A. Performance and quality attributes and conditions not expressly stated in this specification document are intended to be excluded and do not form a part of this specification document.
- B. Electrical specifications and performance data contained in this specification document are based on Mini-Circuit's applicable established test performance criteria and measurement instructions.
- C. The parts covered by this specification document are subject to Mini-Circuit's standard limited warranty and terms and conditions (collectively, "Standard Terms"). Purchasers of this part are entitled to the rights and benefits contained therein. For a full statement of the Standard Terms and the exclusive rights and remedies thereunder, please visit Mini-Circuit's website at www.minicircuits.com/MC_Store/terms.jsp



Digital Step Attenuator

ZX76-31R5A-SP+

Typical Performance Data

TEST CONDITIONS: INPUT POWER=0 dBm, Vdd=+3V, TEMPERATURE=+85°C

FREQUENCY (MHz)	INPUT RETURN LOSS AT TTL CONTROL STATE (dB)							
	000000 0 dB	000001 0.5 dB	000010 1.0 dB	000100 2.0 dB	001000 4.0 dB	010000 8.0 dB	100000 16 dB	111111 31.5 dB
0.1	18.17	19.34	20.32	18.20	18.45	19.87	25.76	29.49
0.3	18.16	19.34	20.31	18.19	18.44	19.85	25.71	29.47
0.5	18.15	19.32	20.30	18.14	18.37	19.75	25.61	29.50
1	18.06	19.26	20.24	18.09	18.32	19.73	25.60	29.53
5	17.96	19.15	20.14	18.04	18.30	19.74	25.64	29.60
10	17.94	19.14	20.12	18.03	18.29	19.73	25.64	29.60
50	17.94	19.14	20.12	18.04	18.32	19.77	25.72	29.72
100	17.94	19.14	20.13	18.06	18.35	19.84	25.86	29.97
200	17.92	19.14	20.15	18.12	18.45	19.98	26.21	30.55
300	17.92	19.15	20.18	18.17	18.54	20.14	26.51	31.06
400	17.91	19.15	20.21	18.23	18.62	20.26	26.69	31.39
500	17.96	19.19	20.25	18.27	18.63	20.20	26.35	30.77
600	17.96	19.18	20.21	18.22	18.54	20.05	25.86	29.96
700	17.97	19.16	20.18	18.18	18.46	19.90	25.36	29.13
800	17.87	19.03	20.01	18.02	18.27	19.61	24.69	28.16
900	17.85	18.98	19.93	17.93	18.15	19.42	24.28	27.61
1000	17.82	18.93	19.85	17.83	18.01	19.23	23.81	26.97
1100	17.67	18.74	19.62	17.63	17.81	18.98	23.38	26.41
1200	17.62	18.68	19.54	17.56	17.72	18.87	23.19	26.20
1300	17.58	18.60	19.35	17.32	17.37	18.31	22.00	24.76
1400	17.46	18.42	19.12	17.04	16.96	17.70	20.84	23.35
1500	17.47	18.37	19.02	16.84	16.64	17.23	20.04	22.37
1600	17.53	18.37	18.95	16.71	16.41	16.89	19.48	21.64
1700	17.65	18.43	18.93	16.65	16.27	16.68	19.13	21.12
1800	17.63	18.33	18.77	16.53	16.15	16.58	18.98	20.81
1900	17.47	18.07	18.43	16.34	15.96	16.45	18.82	20.40
2000	17.09	17.59	17.86	16.07	15.79	16.40	18.82	20.12
2100	16.65	17.05	17.26	15.81	15.66	16.44	18.99	19.95
2200	16.08	16.41	16.58	15.50	15.52	16.55	19.25	19.77
2300	15.42	15.68	15.81	15.12	15.33	16.66	19.56	19.48
2400	14.86	15.07	15.15	14.84	15.26	16.92	20.14	19.26
2500	14.65	14.84	14.90	14.77	15.31	17.19	20.62	19.24
2600	14.49	14.67	14.71	14.74	15.40	17.52	21.20	19.26
2700	14.37	14.53	14.55	14.74	15.52	17.91	21.85	19.27
2800	14.17	14.33	14.33	14.66	15.56	18.18	22.28	19.12
2900	13.95	14.09	14.07	14.56	15.57	18.42	22.55	18.84
3000	13.78	13.89	13.87	14.50	15.60	18.66	22.69	18.54
3200	13.65	13.69	13.62	14.56	15.81	19.05	22.09	17.73
3400	13.64	13.60	13.46	14.61	15.85	18.64	20.07	16.60
3600	13.68	13.56	13.32	14.53	15.62	17.54	17.84	15.40
3800	13.42	13.23	12.92	14.08	14.93	16.05	15.79	14.08
4000	13.27	13.08	12.72	13.81	14.45	15.07	14.39	12.99
4200	14.36	14.07	13.53	14.67	15.02	14.87	13.55	12.34
4400	16.94	16.24	15.27	16.71	16.38	14.84	12.85	11.97
4600	20.89	18.96	17.28	19.05	17.44	14.43	12.13	11.64
4800	23.44	20.20	18.32	19.65	17.21	13.62	11.37	11.29
5000	20.80	18.90	17.80	18.42	16.32	12.92	10.83	11.08

Notes

- A. Performance and quality attributes and conditions not expressly stated in this specification document are intended to be excluded and do not form a part of this specification document.
- B. Electrical specifications and performance data contained in this specification document are based on Mini-Circuits' applicable established test performance criteria and measurement instructions.
- C. The parts covered by this specification document are subject to Mini-Circuits' standard limited warranty and terms and conditions (collectively, "Standard Terms"). Purchasers of this part are entitled to the rights and benefits contained therein. For a full statement of the Standard Terms and the exclusive rights and remedies thereunder, please visit Mini-Circuits' website at www.minicircuits.com/MC_Store/terms.jsp



Digital Step Attenuator

ZX76-31R5A-SP+

Typical Performance Data

TEST CONDITIONS: INPUT POWER=0 dBm, Vdd=+3V, TEMPERATURE=+85°C

FREQUENCY (MHz)	OUTPUT RETURN LOSS AT TTL CONTROL STATE							
	(dB)							
	000000 0 dB	000001 0.5 dB	000010 1.0 dB	000100 2.0 dB	001000 4.0 dB	010000 8.0 dB	100000 16 dB	111111 31.5 dB
0.1	18.03	18.36	18.23	21.73	23.27	23.97	21.63	31.20
0.3	18.03	18.35	18.22	21.72	23.25	23.94	21.62	31.19
0.5	17.93	18.26	18.14	21.63	23.14	23.81	21.48	31.19
1	17.92	18.27	18.14	21.65	23.16	23.82	21.48	31.22
5	17.84	18.20	18.08	21.58	23.13	23.86	21.55	31.35
10	17.83	18.18	18.07	21.57	23.12	23.86	21.55	31.36
50	17.88	18.25	18.14	21.66	23.24	24.00	21.67	31.66
100	18.03	18.40	18.28	21.87	23.47	24.25	21.86	32.21
200	18.13	18.52	18.42	22.12	23.81	24.69	22.22	33.46
300	18.29	18.69	18.59	22.37	24.14	25.06	22.51	34.65
400	18.19	18.59	18.51	22.25	24.05	25.01	22.50	34.62
500	18.10	18.48	18.39	22.01	23.71	24.55	22.14	33.10
600	17.89	18.26	18.16	21.64	23.24	24.01	21.74	31.74
700	17.76	18.12	18.01	21.36	22.88	23.57	21.37	30.67
800	17.69	18.04	17.91	21.18	22.61	23.21	21.07	29.90
900	17.75	18.10	17.95	21.22	22.60	23.13	20.98	29.71
1000	17.80	18.14	17.99	21.23	22.56	23.02	20.86	29.43
1100	17.83	18.16	18.00	21.24	22.53	22.93	20.77	29.24
1200	17.94	18.26	18.09	21.34	22.60	22.92	20.72	29.18
1300	17.77	18.02	17.84	20.82	21.78	21.79	19.71	26.91
1400	17.76	17.95	17.69	20.50	21.18	20.93	18.93	25.23
1500	17.75	17.87	17.55	20.18	20.59	20.17	18.24	23.73
1600	17.86	17.88	17.49	19.96	20.13	19.63	17.80	22.53
1700	17.89	17.83	17.38	19.64	19.62	19.15	17.48	21.41
1800	17.82	17.67	17.19	19.23	19.10	18.78	17.32	20.47
1900	17.67	17.45	16.97	18.78	18.59	18.50	17.29	19.67
2000	17.42	17.17	16.72	18.27	18.12	18.35	17.46	19.03
2100	17.02	16.76	16.37	17.67	17.61	18.21	17.72	18.40
2200	16.54	16.29	15.98	17.05	17.11	18.16	18.19	17.85
2300	15.95	15.76	15.58	16.44	16.66	18.21	18.91	17.40
2400	15.33	15.21	15.15	15.85	16.23	18.32	19.88	17.02
2500	15.00	14.92	14.91	15.53	15.98	18.32	20.39	16.79
2600	14.67	14.63	14.66	15.21	15.73	18.32	20.95	16.56
2700	14.40	14.39	14.46	14.94	15.52	18.33	21.56	16.35
2800	14.12	14.14	14.25	14.68	15.31	18.34	22.20	16.14
2900	13.88	13.93	14.09	14.45	15.13	18.37	22.84	15.96
3000	13.67	13.76	13.95	14.25	14.98	18.40	23.41	15.77
3200	13.66	13.78	14.00	14.16	14.87	18.47	23.82	15.38
3400	13.96	14.11	14.34	14.25	14.93	18.58	23.13	15.11
3600	14.64	14.78	15.03	14.64	15.23	18.70	21.38	14.92
3800	15.86	16.01	16.28	15.29	15.64	18.30	18.93	14.63
4000	16.60	16.72	16.96	15.36	15.50	17.18	16.62	14.15
4200	17.42	17.51	17.69	15.53	15.42	16.20	14.93	13.61
4400	19.82	19.78	19.84	16.44	15.90	15.59	13.77	13.26
4600	25.13	24.29	23.81	17.81	16.62	15.00	12.82	13.08
4800	27.99	26.00	24.89	18.42	16.81	14.20	11.91	12.87
5000	22.45	21.95	21.71	18.06	16.62	13.56	11.28	12.75

Notes

- A. Performance and quality attributes and conditions not expressly stated in this specification document are intended to be excluded and do not form a part of this specification document.
- B. Electrical specifications and performance data contained in this specification document are based on Mini-Circuits' applicable established test performance criteria and measurement instructions.
- C. The parts covered by this specification document are subject to Mini-Circuits' standard limited warranty and terms and conditions (collectively, "Standard Terms"); Purchasers of this part are entitled to the rights and benefits contained therein. For a full statement of the Standard Terms and the exclusive rights and remedies thereunder, please visit Mini-Circuits' website at www.minicircuits.com/MC_Store/terms.jsp



Digital Step Attenuator

ZX76-31R5A-SP+

Typical Performance Curves

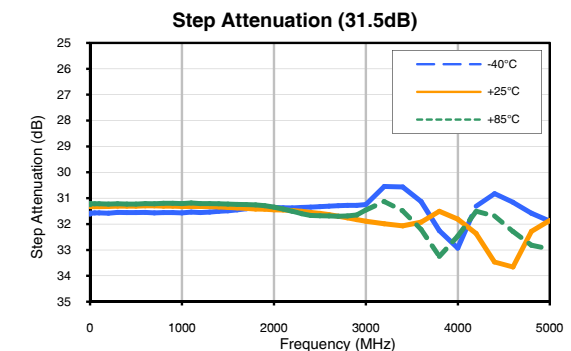
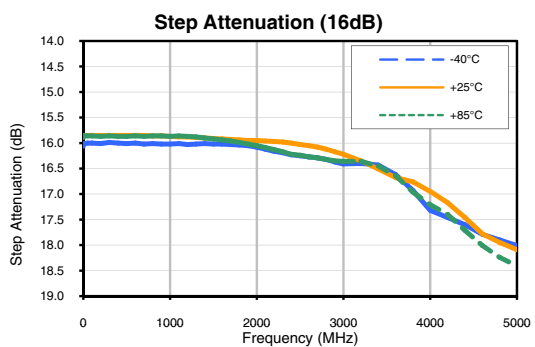
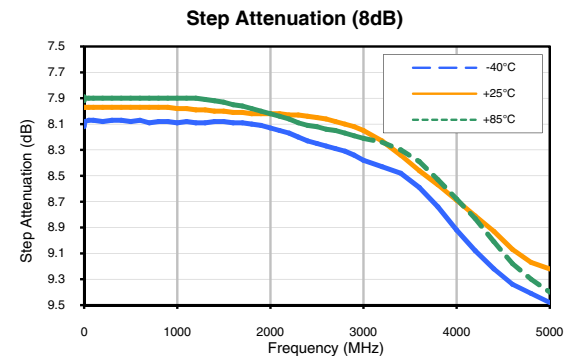
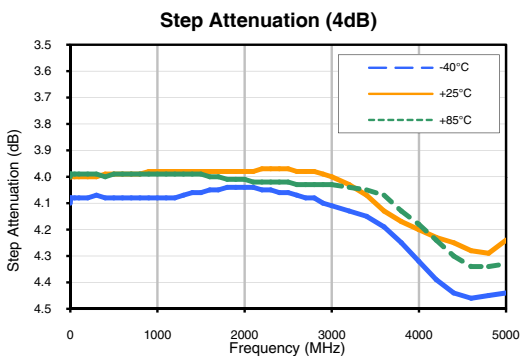
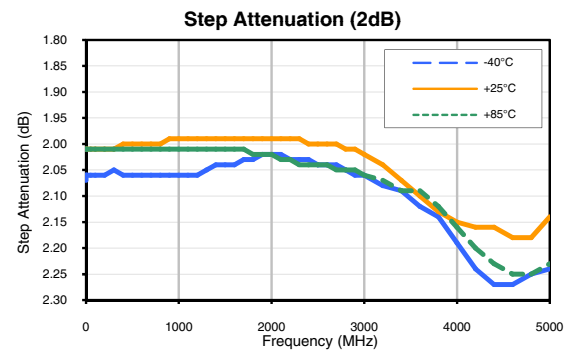
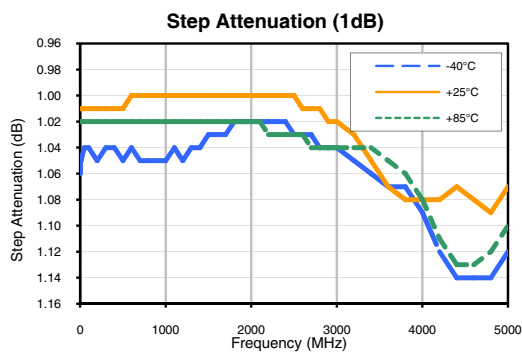
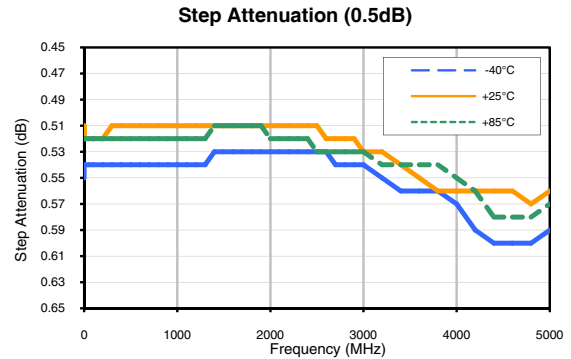
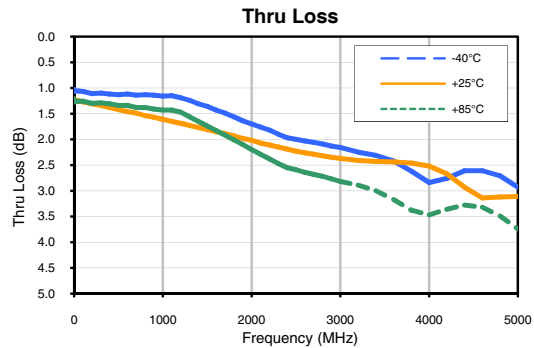

Notes

- A. Performance and quality attributes and conditions not expressly stated in this specification document are intended to be excluded and do not form a part of this specification document.
- B. Electrical specifications and performance data contained in this specification document are based on Mini-Circuits' applicable established test performance criteria and measurement instructions.
- C. The parts covered by this specification document are subject to Mini-Circuits' standard limited warranty and terms and conditions (collectively, "Standard Terms"). Purchasers of this part are entitled to the rights and benefits contained therein. For a full statement of the Standard Terms and the exclusive rights and remedies thereunder, please visit Mini-Circuits' website at www.minicircuits.com/MCLStore/terms.jsp



Digital Step Attenuator

ZX76-31R5A-SP+

Typical Performance Curves

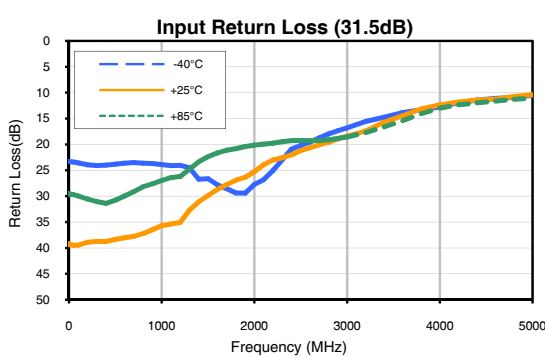
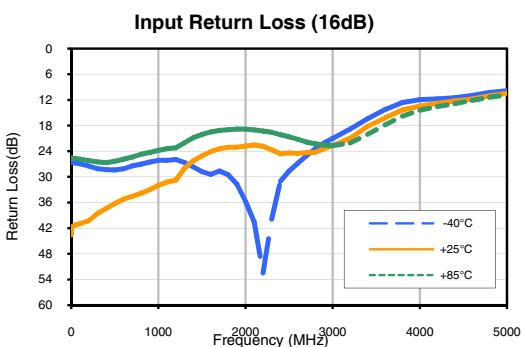
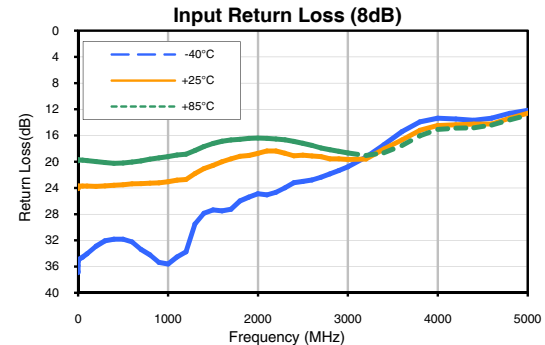
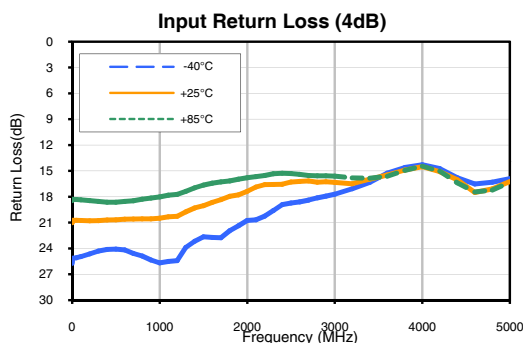
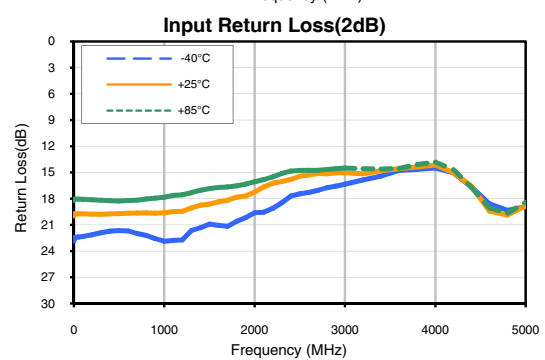
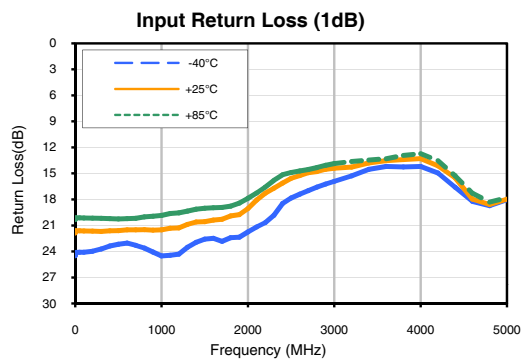
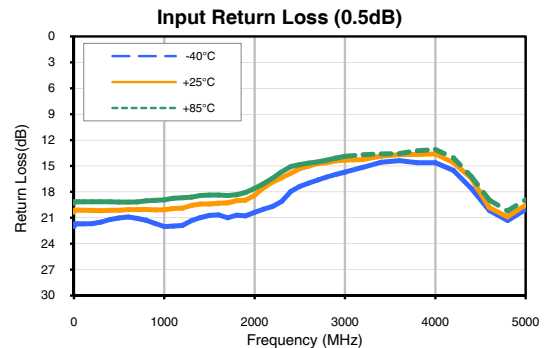
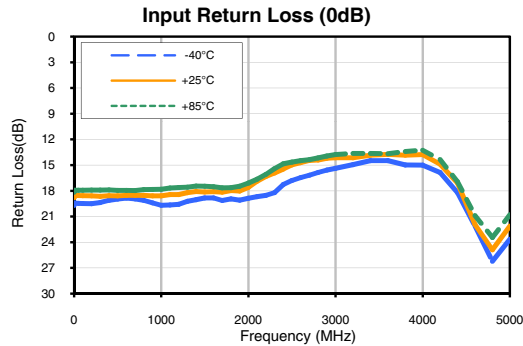

Notes

- A. Performance and quality attributes and conditions not expressly stated in this specification document are intended to be excluded and do not form a part of this specification document.
- B. Electrical specifications and performance data contained in this specification document are based on Mini-Circuits' applicable established test performance criteria and measurement instructions.
- C. The parts covered by this specification document are subject to Mini-Circuits' standard limited warranty and terms and conditions (collectively, "Standard Terms"). Purchasers of this part are entitled to the rights and benefits contained therein. For a full statement of the Standard Terms and the exclusive rights and remedies thereunder, please visit Mini-Circuits' website at www.minicircuits.com/MCLStore/terms.jsp



Digital Step Attenuator

ZX76-31R5A-SP+

Typical Performance Curves

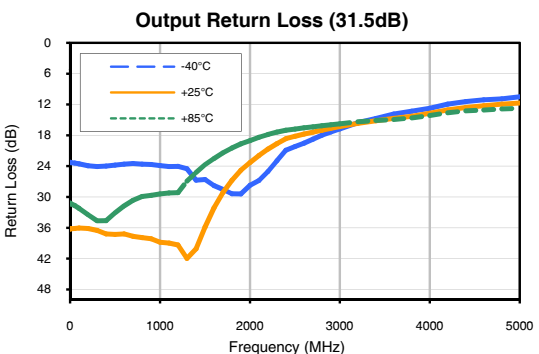
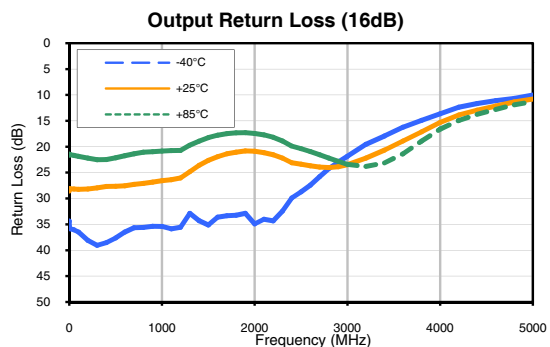
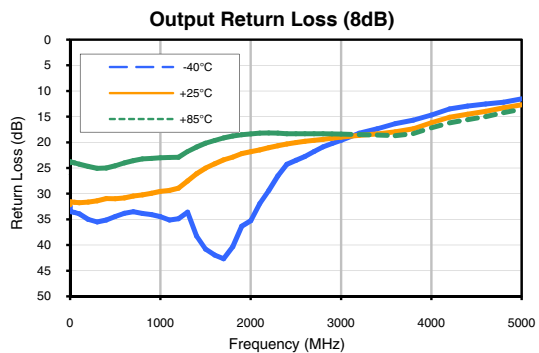
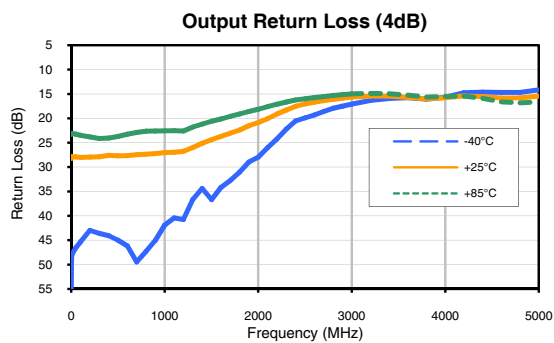
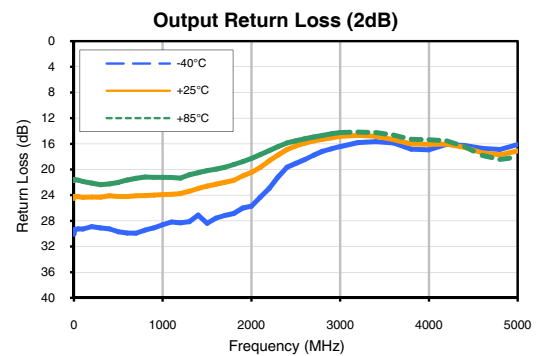
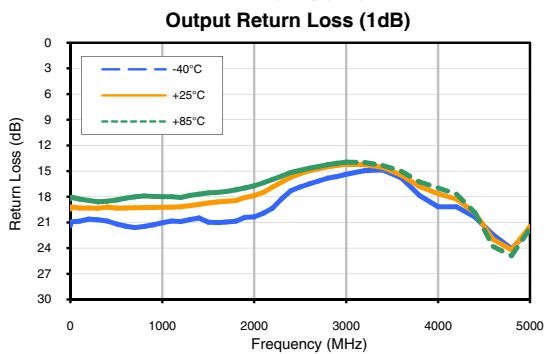
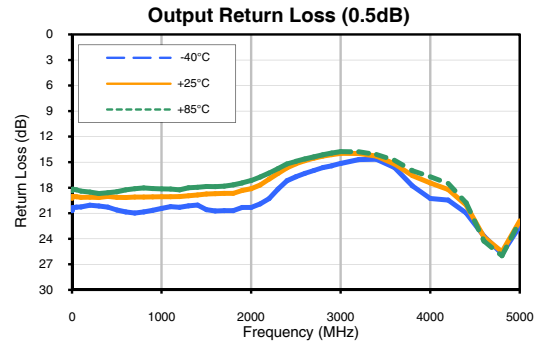
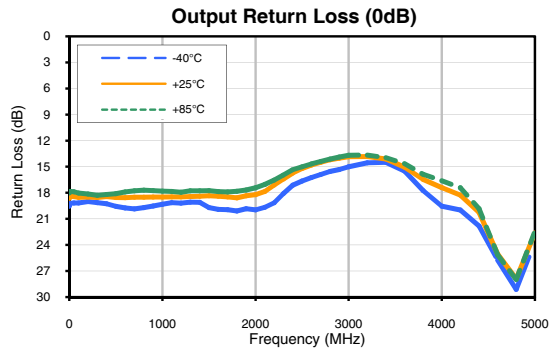

Notes

- A. Performance and quality attributes and conditions not expressly stated in this specification document are intended to be excluded and do not form a part of this specification document.
- B. Electrical specifications and performance data contained in this specification document are based on Mini-Circuits' applicable established test performance criteria and measurement instructions.
- C. The parts covered by this specification document are subject to Mini-Circuits' standard limited warranty and terms and conditions (collectively, "Standard Terms"). Purchasers of this part are entitled to the rights and benefits contained therein. For a full statement of the Standard Terms and the exclusive rights and remedies thereunder, please visit Mini-Circuits' website at www.minicircuits.com/MCLStore/terms.jsp



Case Style

HK

Outline Dimensions

HK1172

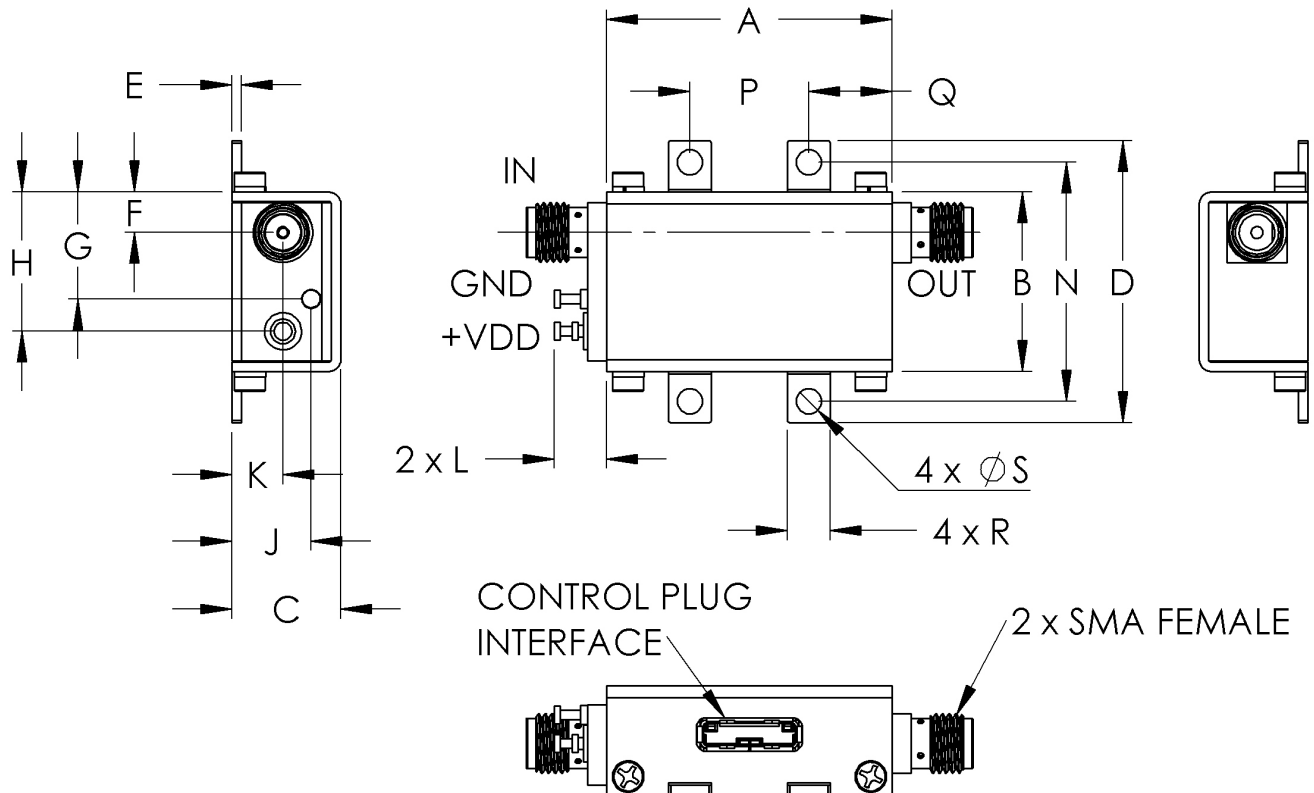

CASE #.	A	B	C	D	E	F	G	H	J	K	L	M	N
HK1172	1.20 (30.48)	.75 (19.15)	.46 (11.61)	1.18 (30.07)	.04 (1.02)	.17 (4.32)	.45 (11.40)	.59 (14.86)	.33 (8.31)	.21 (5.44)	.22 (5.59)	-	1.00 (25.4)

CASE #.	P	Q	R	S	WT GRAMS
HK1172	.50 (12.70)	.35 (8.89)	.18 (4.57)	.106 (2.69)	35

Dimensions are in inches (mm). Tolerances: 2Pl. $\pm .03$; 3Pl. $\pm .015$
Tolerance on hole size and interaxes dimensions to be $\pm .005$.

Note:

1. Case material: Brass
2. Case finish: Nickel plate

Mini-Circuits[®]

Distribution Centers NORTH AMERICA 800-654-7949 • 417-335-5935 • Fax 417-335-5945 • EUROPE 44-1252-832600 • Fax 44-1252-837010

Mini-Circuits ISO 9001 & ISO 14001 Certified

INTERNET <http://www.minicircuits.com>

P.O. Box 350166, Brooklyn, New York 11235-0003 (718) 934-4500 Fax (718) 332-4661

All Mini-Circuits products are manufactured under exacting quality assurance and control standards, and are capable of meeting published specifications after being subjected to any or all of the following physical and environmental test.

Specification	Test/Inspection Condition	Reference/Spec
Operating Temperature	-40° to 85° C Ambient Environment	Individual Model Data Sheet
Storage Temperature	-40° to 85° C Ambient Environment	Individual Model Data Sheet
Barometric Pressure	100,000 Feet	MIL-STD-202, Method 105, Condition D
Humidity	90% RH, 65°C Units may require bake-out after humidity to restore full performance.	MIL-STD-202, Method 103
Thermal Shock	-65° to 125°C, 5 cycles	MIL-STD-202, Method 107, Condition B
Vibration (High Frequency)	20g peak, 10-2000 Hz, 12 times in each of three perpendicular directions (total 36)	MIL-STD-202, Method 204, Condition D
Mechanical Shock	100g, 6ms sawtooth, 3 shocks each direction 3 axes (total 18)	MIL-STD-202, Method 213, Condition I