



COAXIAL WIDEBAND

Digital Step Attenuator

ZX76-31A-PNS+

50Ω 31 dB, 1 dB Step DC to 4 GHz

THE BIG DEAL

- 5-bit digital step attenuator
- High speed parallel control interface
- Low insertion loss
- Fast attenuation transitions
- No control software or PC required



Generic photo used for illustration purposes only

APPLICATIONS

- Test Setup
- Lab
- Instrumentation

| | |
|------------|---------------|
| Model No. | ZX76-31A-PNS+ |
| Case Style | HK1149 |
| Connectors | SMA |

RoHS Compliant

See our website for RoHS Compliance methodologies and qualifications

PRODUCT OVERVIEW

ZX76-31A-PNS+ is a 5-bit digital step attenuator with parallel control and dual (positive and negative) supply voltage inputs. Attenuation can be set from 0 to 31 dB in 1 dB steps, with 0.1 dB typical accuracy. The attenuator is housed in a compact unibody package, with SMA RF connections and a snap-fit control input.

The high speed parallel control interface supports manual control and integration with a wide range of microcontroller and custom I/O (input / output) control systems. Data is entered into the internal 5-bit register using 5V logic levels and then latched to set the attenuation.

For applications requiring Ethernet / USB control and software support, please review Mini-Circuits' R_DAT series of programmable attenuators at <https://www.minicircuits.com/WebStore/RF-Programmable-Step-Attenuators.html>

KEY FEATURES

| Feature | Advantages |
|--------------------------------------|--|
| Wideband operation, from DC to 4 GHz | Supports a range of applications in communications, satellite and defense. |
| Excellent RF performance | Low insertion loss and 18 dB typical return loss minimize the impact on overall system performance. |
| Dual voltage supply inputs | Separate positive & negative supply rails reduce the noise & spurious effects associated with internal negative voltage generators and allow faster attenuation switching (up to 1 MHz). |
| Parallel control | High speed parallel control, no PC, software control or clock needed. Allows manual control of attenuation setting. Designed for integration with generic control systems at 5V logic levels. |



RF ELECTRICAL SPECIFICATIONS, DC - 4 GHz, $T_{AMB}=25^{\circ}\text{C}$, $V_{DD}=+3\text{V}$, $V_{SS}=-3.3\text{V}$

| Parameter | Frequency (MHz) | Min. | Typ. | Max. | Units |
|---|-----------------|------|------------|--------------|-------|
| Insertion Loss @ 0dB Attenuation Setting | DC - 1000 | — | 1.4 | 2.0 | dB |
| | 1000 - 2400 | — | 1.9 | 2.7 | |
| | 2400 - 4000 | — | 2.5 | 3.3 | |
| Accuracy @ 1 dB Attenuation Setting | DC - 1000 | — | ± 0.02 | ± 0.10 | dB |
| | 1000 - 2400 | — | ± 0.05 | ± 0.15 | |
| | 2400 - 4000 | — | ± 0.10 | ± 0.25 | |
| Accuracy @ 2 dB Attenuation Setting | DC - 1000 | — | ± 0.05 | ± 0.15 | dB |
| | 1000 - 2400 | — | ± 0.15 | ± 0.25 | |
| | 2400 - 4000 | — | ± 0.15 | ± 0.35 | |
| Accuracy @ 4 dB Attenuation Setting | DC - 1000 | — | ± 0.07 | ± 0.20 | dB |
| | 1000 - 2400 | — | ± 0.15 | ± 0.25 | |
| | 2400 - 4000 | — | ± 0.23 | ± 0.50 | |
| Accuracy @ 8 dB Attenuation Setting | DC - 1000 | — | ± 0.03 | ± 0.25 | dB |
| | 1000 - 2400 | — | ± 0.15 | ± 0.50 | |
| | 2400 - 4000 | — | ± 0.60 | ± 0.80 | |
| Accuracy @ 16 dB Attenuation Setting | DC - 1000 | — | ± 0.10 | ± 0.30 | dB |
| | 1000 - 2400 | — | ± 0.15 | ± 0.70 | |
| | 2400 - 4000 | — | ± 1.10 | ± 1.45 | |
| Input IP3 (at Min. and Max. Attenuation) ¹ | DC - 4000 | — | +52 | — | dBm |
| Input Power @ 0.2dB Compression (at Min. and Max. Attenuation) ¹ | DC - 4000 | — | +24 | — | |
| Input Operating Power | 0.010 - 50 | — | — | See figure 1 | dBm |
| | 50 - 4000 | — | — | +24 | |
| Return Loss | DC - 1000 | 12.5 | 21 | — | dB |
| | 1000 - 2400 | 11.5 | 18 | — | |
| | 2400 - 4000 | 10.0 | 14 | — | |

1. Input IP3 and 1dB compression degrade below 1 MHz. Input power not to exceed max operating specification for continuous operation.

DC ELECTRICAL SPECIFICATIONS

| Parameter | Min. | Typ. | Max. | Units |
|-----------------------------------|----------------|------|----------------|---------------|
| Positive Supply Voltage, V_{DD} | +2.7 | +3 | +3.6 | V |
| Positive Supply Current, I_{DD} | — | — | 3 | mA |
| Negative Supply Voltage, V_{SS} | -3.6 | -3.3 | -3.2 | V |
| Negative Supply Current, I_{SS} | — | 16 | 40 | μA |
| Control Input Low | -0.3 | — | +0.3x V_{DD} | V |
| Control Input High | +0.7x V_{DD} | — | +5 | V |
| Control Current | — | — | 400 | μA |

SWITCHING SPECIFICATIONS

| Parameter | Min. | Typ. | Max. | Units |
|--|------|------|------|-----------------|
| Switching Speed, 50% Control to 0.5dB of Attenuation Value | — | 1 | — | μsec |
| Switching Control Frequency | — | 1 | — | MHz |

FIGURE 1: Max Input Operating Power vs Frequency

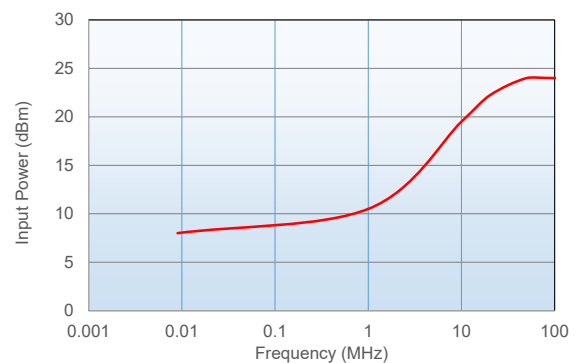



ABSOLUTE MAXIMUM RATINGS

| Parameter | Ratings |
|------------------------------|------------------------|
| Operating Temperature | -40°C to 85°C |
| Storage Temperature | -40°C to 85°C |
| V _{DD} | -0.3V Min., +5.5V Max. |
| V _{SS} | -3.6V Min., +0.3V Max. |
| Voltage on any control input | -0.3V Min., +6V Max. |
| ESD, HBM | 500V |
| ESD, MM | 100V |
| Input Power | +30dBm |

Permanent damage may occur if any of these limits are exceeded. Operating in the range between operating power limits and absolute maximum ratings for extended periods of time may result in reduced life and reliability.

PIN CONFIGURATION

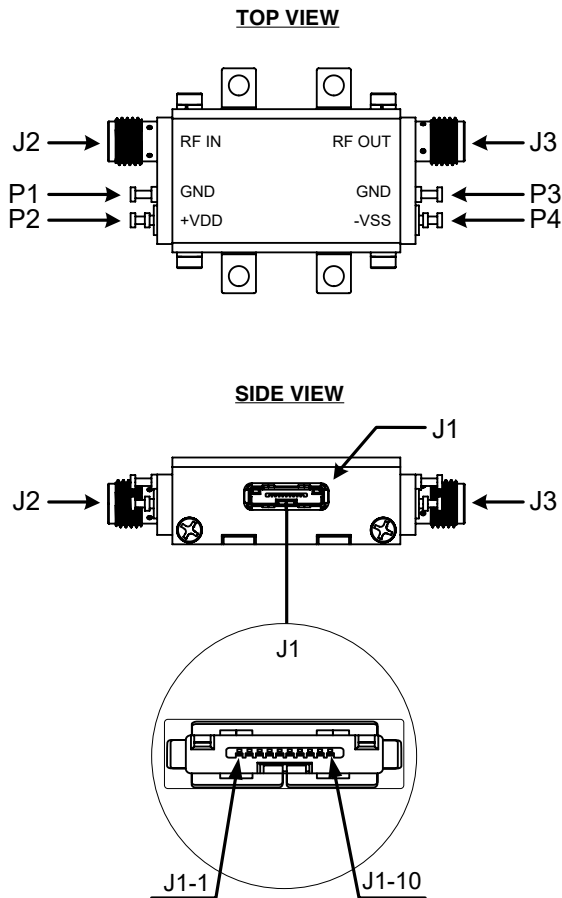

PIN DESCRIPTION

| Function | Pin Number | Description |
|-----------------|------------|-------------------------------------|
| LE | J1-1 | Latch Enable Input |
| C1 | J1-2 | Control for attenuation bit, 1.0 dB |
| N/C | J1-3 | Not Connected |
| N/C | J1-4 | Not Connected |
| C16 | J1-5 | Control for attenuation bit, 16 dB |
| GND | J1-6 | Ground Connection |
| GND | J1-7 | Ground Connection |
| C4 | J1-8 | Control for attenuation bit, 4 dB |
| C8 | J1-9 | Control for attenuation bit, 8 dB |
| C2 | J1-10 | Control for attenuation bit, 2 dB |
| RF in | J2 | RF in port ² |
| RF out | J3 | RF out port ² |
| GND | P1 | Ground Connection |
| V _{DD} | P2 | Positive Supply Voltage |
| GND | P3 | Ground Connection |
| V _{SS} | P4 | Negative Supply Voltage |

² Both RF ports must be held at 0VDC or DC blocked with an external series capacitor.



SIMPLIFIED SCHEMATIC

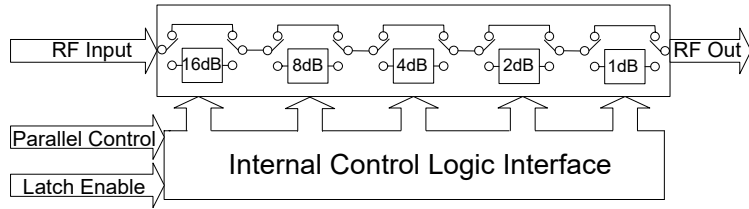

The ZX76-31A-PNS+ parallel interface consists of 6 control bits that select the desired attenuation state, as shown in Table 1: Truth Table.

TABLE 1. TRUTH TABLE

| Attenuation State | C16 | C8 | C4 | C2 | C1 |
|-------------------|-----|----|----|----|----|
| Reference | 0 | 0 | 0 | 0 | 0 |
| 1 (dB) | 0 | 0 | 0 | 0 | 1 |
| 2 (dB) | 0 | 0 | 0 | 1 | 0 |
| 4 (dB) | 0 | 0 | 1 | 0 | 0 |
| 8 (dB) | 0 | 1 | 0 | 0 | 0 |
| 16 (dB) | 1 | 0 | 0 | 0 | 0 |
| 31 (dB) | 1 | 1 | 1 | 1 | 1 |

Note: Not all 62 possible combinations of C1 - C31 are shown in table

The parallel interface timing requirements are defined by Figure 1 (Parallel Interface Timing Diagram) and Table 2 (Parallel Interface AC Characteristics), and the switching speed.

For latched parallel programming the Latch Enable (LE) should be held LOW while changing attenuation state control values, then pulse LE HIGH to LOW (per Figure 1) to latch new attenuation state into the device.

For direct parallel programming, the Latch Enable (LE) line should be pulled HIGH. Changing the attenuation state control values will immediately change the device's state to a new attenuation value. Direct mode is ideal for manual control of the device (using hardware, switches, or jumpers).

Control cables for programming can be ordered separately. For details see page 5.

TABLE 2. PARALLEL INTERFACE AC CHARACTERISTICS

| Symbol | Parameter | Min. | Units |
|-------------|---|------|-------|
| t_{LEPW} | LE minimum pulse width | 10 | ns |
| t_{PDSUP} | Data set-up time before clock rising edge of LE | 10 | ns |
| t_{PDHLD} | Data hold time after clock falling edge of LE | 10 | ns |

FIGURE 1: PARALLEL INTERFACE TIMING DIAGRAM

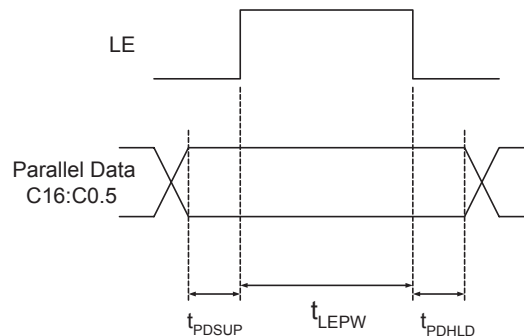

POWER-UP STATE

When the attenuator powers up and LE is logic low, the nominal attenuation is set on 0 dB. When LE is logic high, the nominal attenuation selected upon control logics (see Table 1).



ZX76-WP+ CONTROL CABLE

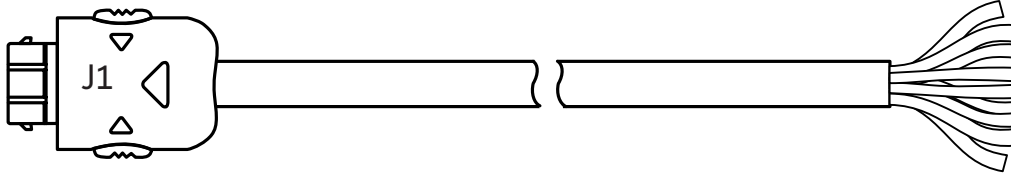

RECOMMENDED ACCESSORIES

An optional ZX76-WP+ is a shielded cable on one end and a connector on the other end designed to mate to the ZX76-31A-PNS+. These bare wires enable the customer to assemble their own cable as required to interface with the ZX76-31A-PNS+ (cable length is 4.9ft/ 1.5meters).

ZX76-WP+ WIRING INFORMATION

| J1 Pin Number | Function | Description | Wire Color |
|---------------|----------|--------------------------------------|------------|
| J1-1 | LE | Latch Enable Input | White |
| J1-2 | C1 | Control for attenuation bit, 1.0 dB | Yellow |
| J1-5 | C16 | Control for attenuation bit, 16.0 dB | Blue |
| J1-6 | GND | Ground Connection | Black |
| J1-8 | C4 | Control for attenuation bit, 4.0 dB | Orange |
| J1-9 | C8 | Control for attenuation bit, 8.0 dB | Brown |
| J1-10 | C2 | Control for attenuation bit, 2.0 dB | Red |

Note: Other pins not connected. Cable shield connected to case ground.



TYPICAL PERFORMANCE DATA (AT 25°C)

| Freq. [MHz] | I.Loss [dB] | Attenuation relative to Insertion Loss [dB] | | | | | | |
|----------------|----------------|--|-------|-------|-------|-------|-------|-------|
| | | @ Attenuation setting [dB] | | | | | | |
| | | 0.5 | 1 | 2 | 4 | 8 | 16 | 31 |
| 0.1 | -1.21 | 0.46 | -0.01 | -0.01 | 0.00 | 0.03 | 0.15 | 0.23 |
| 1 | -1.23 | 0.47 | -0.01 | -0.01 | 0.00 | 0.03 | 0.15 | 0.22 |
| 10 | -1.24 | 0.47 | -0.01 | -0.01 | 0.00 | 0.03 | 0.15 | 0.21 |
| 100 | -1.27 | 0.47 | -0.01 | -0.01 | 0.00 | 0.03 | 0.15 | 0.22 |
| 200 | -1.31 | 0.47 | -0.01 | -0.01 | 0.00 | 0.03 | 0.15 | 0.23 |
| 400 | -1.38 | 0.47 | -0.01 | 0.00 | 0.01 | 0.03 | 0.15 | 0.23 |
| 500 | -1.42 | 0.47 | -0.01 | 0.00 | 0.01 | 0.03 | 0.15 | 0.25 |
| 700 | -1.49 | 0.47 | 0.00 | 0.00 | 0.01 | 0.03 | 0.15 | 0.25 |
| 800 | -1.54 | 0.47 | 0.00 | 0.00 | 0.01 | 0.03 | 0.14 | 0.24 |
| 1000 | -1.61 | 0.47 | 0.00 | 0.01 | 0.02 | 0.02 | 0.13 | 0.23 |
| 1100 | -1.65 | 0.47 | 0.00 | 0.01 | 0.02 | 0.02 | 0.12 | 0.24 |
| 1300 | -1.73 | 0.47 | 0.00 | 0.01 | 0.02 | 0.01 | 0.11 | 0.25 |
| 1450 | -1.79 | 0.47 | 0.00 | 0.01 | 0.01 | 0.00 | 0.09 | 0.18 |
| 1750 | -1.92 | 0.47 | 0.00 | 0.01 | 0.02 | -0.01 | 0.07 | 0.04 |
| 1900 | -1.98 | 0.48 | 0.00 | 0.01 | 0.02 | -0.02 | 0.05 | -0.01 |
| 2200 | -2.11 | 0.47 | 0.00 | 0.01 | 0.03 | -0.03 | 0.03 | 0.58 |
| 2350 | -2.18 | 0.47 | 0.00 | 0.01 | 0.03 | -0.03 | 0.01 | 0.27 |
| 2650 | -2.29 | 0.46 | -0.01 | 0.00 | 0.03 | -0.06 | -0.06 | -1.40 |
| 2800 | -2.32 | 0.46 | -0.01 | -0.01 | 0.02 | -0.10 | -0.12 | -1.50 |
| 3100 | -2.39 | 0.46 | -0.03 | -0.03 | -0.01 | -0.19 | -0.28 | 0.17 |
| 3250 | -2.41 | 0.46 | -0.04 | -0.05 | -0.04 | -0.26 | -0.39 | 0.16 |
| 3550 | -2.44 | 0.46 | -0.06 | -0.10 | -0.11 | -0.43 | -0.64 | -0.45 |
| 3700 | -2.45 | 0.46 | -0.07 | -0.12 | -0.15 | -0.52 | -0.72 | -0.72 |
| 3900 | -2.48 | 0.46 | -0.08 | -0.14 | -0.19 | -0.63 | -0.85 | -0.85 |
| 4000 | -2.52 | 0.45 | -0.08 | -0.15 | -0.20 | -0.69 | -0.95 | -0.74 |

| Freq. [MHz] | Return Loss In [dB] | | | | | | | | Return Loss Out [dB] | | | | | | | |
|----------------|----------------------------|--------|--------|--------|--------|--------|--------|--------|----------------------------|--------|--------|--------|--------|--------|--------|--------|
| | @ Attenuation setting [dB] | | | | | | | | @ Attenuation setting [dB] | | | | | | | |
| | 0 | 0.5 | 1 | 2 | 4 | 8 | 16 | 31 | 0 | 0.5 | 1 | 2 | 4 | 8 | 16 | 31 |
| 0.1 | -18.79 | -20.34 | -21.87 | -19.97 | -21.00 | -24.11 | -43.54 | -42.52 | -18.63 | -19.24 | -19.43 | -24.48 | -28.24 | -32.18 | -28.59 | -47.11 |
| 1 | -18.66 | -20.23 | -21.75 | -19.81 | -20.79 | -23.77 | -41.88 | -42.64 | -18.51 | -19.13 | -19.30 | -24.34 | -27.99 | -31.68 | -28.14 | -47.23 |
| 10 | -18.54 | -20.10 | -21.62 | -19.72 | -20.73 | -23.73 | -41.56 | -42.89 | -18.39 | -19.02 | -19.21 | -24.20 | -27.86 | -31.61 | -28.16 | -47.70 |
| 100 | -18.57 | -20.12 | -21.63 | -19.74 | -20.74 | -23.72 | -40.92 | -43.49 | -18.52 | -19.15 | -19.33 | -24.35 | -28.02 | -31.76 | -28.24 | -47.09 |
| 200 | -18.59 | -20.15 | -21.66 | -19.77 | -20.78 | -23.77 | -40.26 | -43.48 | -18.49 | -19.12 | -19.30 | -24.30 | -27.94 | -31.64 | -28.17 | -47.13 |
| 400 | -18.58 | -20.12 | -21.61 | -19.73 | -20.70 | -23.60 | -37.38 | -42.97 | -18.42 | -19.03 | -19.22 | -24.10 | -27.58 | -30.96 | -27.69 | -45.60 |
| 500 | -18.59 | -20.12 | -21.60 | -19.72 | -20.68 | -23.53 | -36.24 | -40.56 | -18.53 | -19.14 | -19.32 | -24.22 | -27.69 | -30.98 | -27.66 | -56.03 |
| 700 | -18.54 | -20.05 | -21.51 | -19.64 | -20.58 | -23.35 | -34.55 | -35.20 | -18.51 | -19.11 | -19.28 | -24.10 | -27.46 | -30.44 | -27.27 | -60.30 |
| 800 | -18.53 | -20.03 | -21.49 | -19.63 | -20.56 | -23.28 | -33.81 | -33.08 | -18.50 | -19.10 | -19.27 | -24.06 | -27.37 | -30.24 | -27.11 | -47.75 |
| 1000 | -18.60 | -20.08 | -21.51 | -19.63 | -20.49 | -23.06 | -31.95 | -29.43 | -18.49 | -19.07 | -19.23 | -23.92 | -27.04 | -29.56 | -26.56 | -36.47 |
| 1100 | -18.45 | -19.92 | -21.32 | -19.48 | -20.32 | -22.83 | -31.20 | -28.47 | -18.47 | -19.06 | -19.21 | -23.87 | -26.96 | -29.35 | -26.39 | -32.95 |
| 1300 | -18.21 | -19.58 | -20.87 | -19.05 | -19.74 | -21.82 | -27.94 | -26.73 | -18.43 | -18.96 | -19.05 | -23.40 | -25.97 | -27.52 | -24.83 | -27.66 |
| 1450 | -18.16 | -19.44 | -20.63 | -18.72 | -19.19 | -20.87 | -25.73 | -25.69 | -18.39 | -18.82 | -18.82 | -22.80 | -24.76 | -25.59 | -23.12 | -24.81 |
| 1750 | -18.02 | -19.10 | -20.04 | -17.94 | -18.07 | -19.27 | -23.06 | -24.07 | -18.59 | -18.74 | -18.53 | -21.92 | -22.78 | -23.15 | -21.20 | -20.44 |
| 1900 | -18.03 | -18.96 | -19.75 | -17.70 | -17.77 | -19.05 | -23.03 | -22.99 | -18.33 | -18.34 | -18.09 | -21.00 | -21.52 | -22.19 | -20.81 | -18.71 |
| 2200 | -16.33 | -16.85 | -17.27 | -16.23 | -16.59 | -18.37 | -22.81 | -18.70 | -17.11 | -16.99 | -16.87 | -18.66 | -19.11 | -21.03 | -21.57 | -16.09 |
| 2350 | -15.74 | -16.13 | -16.45 | -15.95 | -16.61 | -18.97 | -24.23 | -15.92 | -16.08 | -16.01 | -16.02 | -17.33 | -17.92 | -20.53 | -22.69 | -15.21 |
| 2650 | -14.58 | -14.86 | -15.07 | -15.20 | -16.20 | -19.23 | -24.51 | -13.28 | -14.64 | -14.69 | -14.85 | -15.74 | -16.50 | -19.69 | -23.85 | -14.42 |
| 2800 | -14.41 | -14.63 | -14.78 | -15.16 | -16.30 | -19.58 | -24.24 | -12.57 | -14.20 | -14.29 | -14.49 | -15.28 | -16.08 | -19.41 | -24.03 | -14.05 |
| 3100 | -14.14 | -14.30 | -14.36 | -15.11 | -16.45 | -19.79 | -22.16 | -11.86 | -13.82 | -13.96 | -14.21 | -14.75 | -15.51 | -18.80 | -22.90 | -13.11 |
| 3250 | -14.11 | -14.22 | -14.22 | -15.13 | -16.46 | -19.38 | -20.38 | -11.72 | -13.91 | -14.08 | -14.34 | -14.75 | -15.46 | -18.62 | -21.91 | -12.74 |
| 3550 | -14.01 | -13.95 | -13.79 | -14.86 | -15.83 | -17.18 | -16.65 | -11.20 | -14.85 | -15.02 | -15.28 | -15.26 | -15.68 | -18.10 | -19.33 | -12.36 |
| 3700 | -13.95 | -13.81 | -13.59 | -14.62 | -15.33 | -15.99 | -15.19 | -11.02 | -15.81 | -15.95 | -16.20 | -15.76 | -15.94 | -17.75 | -18.06 | -12.20 |
| 3900 | -13.72 | -13.53 | -13.24 | -14.13 | -14.52 | -14.60 | -13.64 | -10.74 | -17.04 | -17.14 | -17.36 | -16.18 | -15.99 | -16.83 | -16.21 | -12.10 |
| 4000 | -13.77 | -13.60 | -13.30 | -14.15 | -14.51 | -14.49 | -13.43 | -10.74 | -17.39 | -17.45 | -17.64 | -16.09 | -15.76 | -16.18 | -15.31 | -12.10 |



TYPICAL PERFORMANCE CURVES (AT 25°C)

Attenuation Accuracy relative to Insertion Loss vs. Frequency

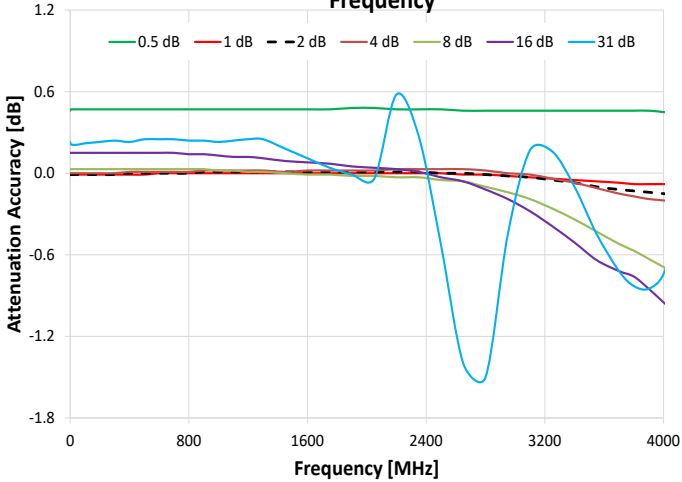

Attenuation relative to Insertion Loss vs. Frequency

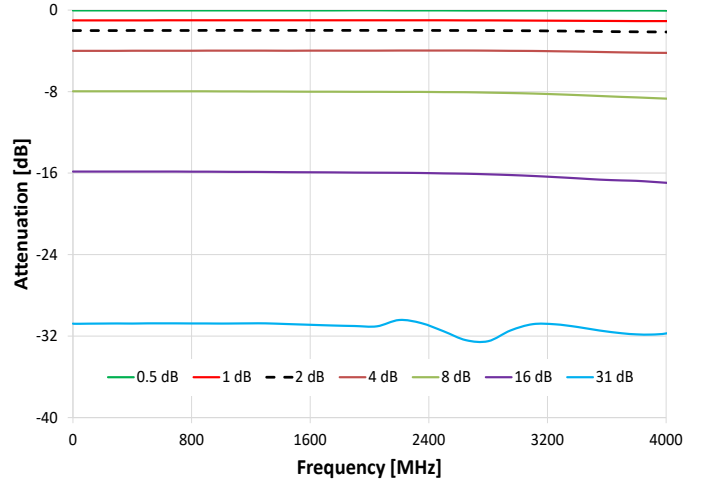

Insertion Loss vs. Frequency

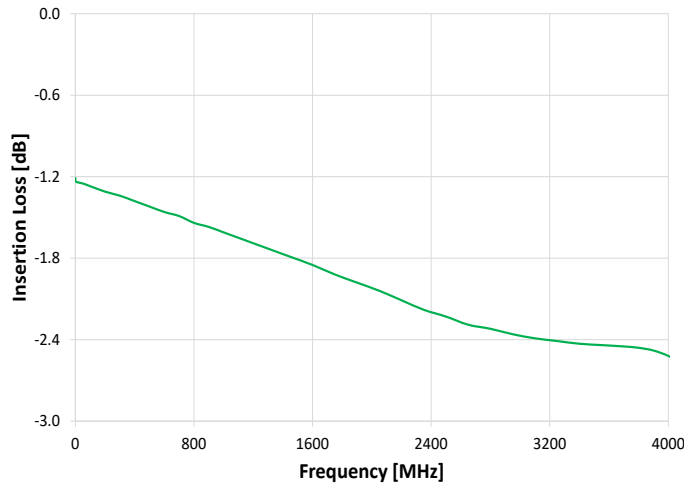

R. Loss In vs. Frequency over Attenuation settings

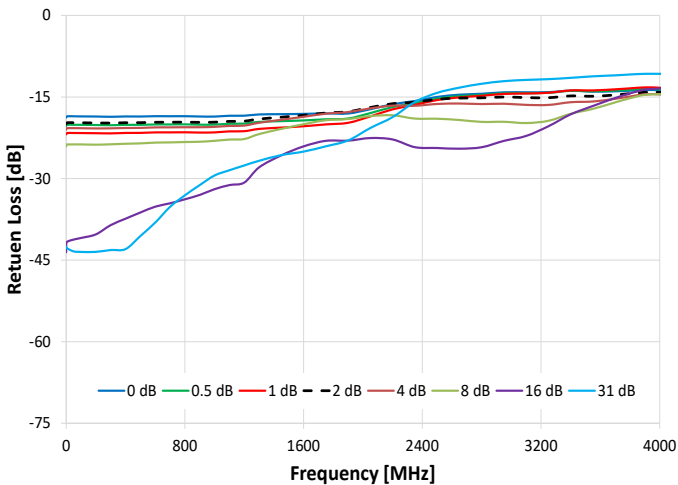

R. Loss Out vs. Frequency over Attenuation settings

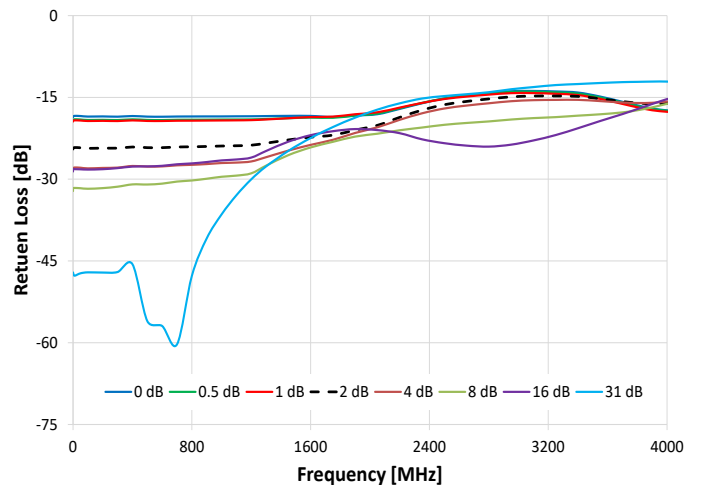



Digital Step Attenuator **ZX76-31A-PNS+**

ORDERING INFORMATION

| Model | Description |
|---------------|---|
| ZX76-31A-PNS+ | Digital attenuator - Parallel interface, Dual Voltage (Positive & Negative) |

| Recommended Accessories | Part No. | Description |
|---|----------|------------------------------|
|  | ZX76-WP+ | 4.9 ft. (1.5M) Control Cable |

ADDITIONAL DETAILED TECHNICAL INFORMATION

| | |
|----------------------|--|
| Performance Data | Data Table |
| | Swept Graphs |
| | S-Parameter (S2P Files) Data Set (.zip.file) |
| Case Style | HK1149 |
| Environmental Rating | ENV28T14 |

Additional information is available on our dash board. To access this information [click here](#)

- NOTES**
- A. Performance and quality attributes and conditions not expressly stated in this specification document are intended to be excluded and do not form a part of this specification document.
 - B. Electrical specifications and performance data contained in this specification document are based on Mini-Circuit's applicable established test performance criteria and measurement instructions.
 - C. The parts covered by this specification document are subject to Mini-Circuits standard limited warranty and terms and conditions (collectively, "Standard Terms"); Purchasers of this part are entitled to the rights and benefits contained therein. For a full statement of the standard. Terms and the exclusive rights and remedies thereunder, please visit Mini-Circuits' website at www.minicircuits.com/MCLStore/terms.jsp

Digital Step Attenuator

ZX76-31A-PN+

Typical Performance Data

TEST CONDITIONS: INPUT POWER=0 dBm, Vdd=+3V, TEMPERATURE=-40°C

| FREQUENCY (MHz) | STEP ATTENUATION* AT TTL CONTROL STATE | | | | | | |
|--------------------|--|------------------|------------------|------------------|------------------|-----------------|-----------------|
| | (dB) | | | | | | |
| | 000000 THRU LOSS | 000010 1.0 dB | 000100 2.0 dB | 001000 4.0 dB | 010000 8.0 dB | 100000 16 dB | 111110 31 dB |
| 0.1 | 1.07 | 1.04 | 2.04 | 4.05 | 8.06 | 15.99 | 30.94 |
| 0.3 | 1.07 | 1.04 | 2.04 | 4.05 | 8.05 | 15.98 | 30.95 |
| 0.5 | 1.09 | 1.04 | 2.04 | 4.04 | 8.04 | 15.96 | 30.95 |
| 1 | 1.10 | 1.03 | 2.03 | 4.04 | 8.03 | 15.95 | 30.96 |
| 5 | 1.09 | 1.03 | 2.04 | 4.04 | 8.03 | 15.95 | 30.96 |
| 10 | 1.09 | 1.03 | 2.04 | 4.04 | 8.03 | 15.95 | 30.97 |
| 50 | 1.09 | 1.03 | 2.03 | 4.04 | 8.02 | 15.94 | 30.97 |
| 100 | 1.10 | 1.03 | 2.03 | 4.04 | 8.02 | 15.94 | 30.95 |
| 200 | 1.14 | 1.03 | 2.03 | 4.04 | 8.02 | 15.95 | 30.94 |
| 300 | 1.13 | 1.03 | 2.03 | 4.03 | 8.01 | 15.93 | 30.92 |
| 400 | 1.15 | 1.03 | 2.03 | 4.03 | 8.02 | 15.94 | 30.92 |
| 500 | 1.16 | 1.03 | 2.03 | 4.04 | 8.03 | 15.94 | 30.92 |
| 600 | 1.15 | 1.03 | 2.03 | 4.04 | 8.03 | 15.94 | 30.92 |
| 700 | 1.17 | 1.04 | 2.04 | 4.05 | 8.04 | 15.96 | 30.92 |
| 800 | 1.16 | 1.03 | 2.04 | 4.04 | 8.04 | 15.95 | 30.91 |
| 900 | 1.17 | 1.03 | 2.04 | 4.04 | 8.04 | 15.96 | 30.91 |
| 1000 | 1.19 | 1.04 | 2.04 | 4.04 | 8.04 | 15.97 | 30.90 |
| 1100 | 1.18 | 1.03 | 2.03 | 4.04 | 8.03 | 15.95 | 30.87 |
| 1200 | 1.21 | 1.04 | 2.04 | 4.04 | 8.04 | 15.97 | 30.84 |
| 1300 | 1.26 | 1.03 | 2.03 | 4.04 | 8.04 | 15.97 | 30.79 |
| 1400 | 1.33 | 1.03 | 2.03 | 4.03 | 8.04 | 15.97 | 30.82 |
| 1500 | 1.38 | 1.02 | 2.02 | 4.03 | 8.05 | 15.98 | 30.84 |
| 1600 | 1.43 | 1.02 | 2.02 | 4.02 | 8.05 | 15.99 | 30.85 |
| 1700 | 1.49 | 1.02 | 2.02 | 4.02 | 8.07 | 16.01 | 30.84 |
| 1800 | 1.56 | 1.02 | 2.01 | 4.02 | 8.08 | 16.03 | 30.83 |
| 1900 | 1.63 | 1.02 | 2.01 | 4.01 | 8.09 | 16.05 | 30.81 |
| 2000 | 1.69 | 1.02 | 2.01 | 4.01 | 8.11 | 16.09 | 30.80 |
| 2100 | 1.76 | 1.02 | 2.01 | 4.02 | 8.13 | 16.14 | 30.81 |
| 2200 | 1.81 | 1.02 | 2.01 | 4.02 | 8.16 | 16.19 | 30.36 |
| 2300 | 1.89 | 1.02 | 2.01 | 4.02 | 8.19 | 16.22 | 30.06 |
| 2400 | 1.95 | 1.02 | 2.01 | 4.03 | 8.22 | 16.27 | 30.44 |
| 2500 | 1.97 | 1.03 | 2.02 | 4.03 | 8.24 | 16.30 | 30.79 |
| 2600 | 2.00 | 1.03 | 2.02 | 4.04 | 8.26 | 16.33 | 31.34 |
| 2700 | 2.03 | 1.03 | 2.02 | 4.04 | 8.28 | 16.36 | 32.08 |
| 2800 | 2.07 | 1.03 | 2.03 | 4.05 | 8.31 | 16.39 | 32.48 |
| 2900 | 2.10 | 1.03 | 2.04 | 4.06 | 8.34 | 16.43 | 32.08 |
| 3000 | 2.13 | 1.03 | 2.04 | 4.07 | 8.37 | 16.47 | 31.19 |
| 3200 | 2.20 | 1.04 | 2.05 | 4.09 | 8.42 | 16.47 | 30.37 |
| 3400 | 2.26 | 1.04 | 2.07 | 4.11 | 8.47 | 16.51 | 30.55 |
| 3600 | 2.37 | 1.04 | 2.08 | 4.14 | 8.57 | 16.67 | 30.93 |
| 3800 | 2.58 | 1.04 | 2.10 | 4.18 | 8.69 | 16.94 | 31.20 |
| 4000 | 2.79 | 1.06 | 2.14 | 4.24 | 8.87 | 17.34 | 31.35 |
| 4200 | 2.73 | 1.09 | 2.19 | 4.30 | 9.02 | 17.49 | 30.39 |
| 4400 | 2.62 | 1.10 | 2.21 | 4.33 | 9.12 | 17.60 | 29.54 |
| 4600 | 2.62 | 1.11 | 2.21 | 4.36 | 9.25 | 17.81 | 28.84 |
| 4800 | 2.72 | 1.10 | 2.20 | 4.35 | 9.33 | 17.94 | 27.76 |
| 5000 | 2.93 | 1.09 | 2.18 | 4.34 | 9.40 | 18.04 | 27.11 |

* Step Attenuation above Thru Loss (TTL Logic 00000).

Notes

- A. Performance and quality attributes and conditions not expressly stated in this specification document are intended to be excluded and do not form a part of this specification document.
- B. Electrical specifications and performance data contained in this specification document are based on Mini-Circuits' applicable established test performance criteria and measurement instructions.
- C. The parts covered by this specification document are subject to Mini-Circuits' standard limited warranty and terms and conditions (collectively, "Standard Terms"). Purchasers of this part are entitled to the rights and benefits contained therein. For a full statement of the Standard Terms and the exclusive rights and remedies thereunder, please visit Mini-Circuits' website at www.minicircuits.com/MC_Store/terms.jsp



Digital Step Attenuator

ZX76-31A-PN+

Typical Performance Data

TEST CONDITIONS: INPUT POWER=0 dBm, Vdd=+3V, TEMPERATURE=-40°C

| FREQUENCY (MHz) | INPUT RETURN LOSS AT TTL CONTROL STATE (dB) | | | | | | |
|--------------------|--|------------------|------------------|------------------|------------------|-----------------|-----------------|
| | 000000 0 dB | 000010 1.0 dB | 000100 2.0 dB | 001000 4.0 dB | 010000 8.0 dB | 100000 16 dB | 111110 31 dB |
| 0.1 | 19.34 | 23.32 | 21.57 | 23.41 | 29.28 | 31.60 | 27.11 |
| 0.3 | 19.32 | 23.30 | 21.55 | 23.38 | 29.22 | 31.70 | 27.13 |
| 0.5 | 19.32 | 23.30 | 21.49 | 23.28 | 28.96 | 31.84 | 27.14 |
| 1 | 19.24 | 23.22 | 21.40 | 23.18 | 28.81 | 31.95 | 27.12 |
| 5 | 19.13 | 23.07 | 21.31 | 23.09 | 28.67 | 32.09 | 27.08 |
| 10 | 19.12 | 23.05 | 21.29 | 23.07 | 28.63 | 32.14 | 27.08 |
| 50 | 19.14 | 23.05 | 21.28 | 23.02 | 28.47 | 32.37 | 27.06 |
| 100 | 19.16 | 23.02 | 21.24 | 22.93 | 28.19 | 32.77 | 27.08 |
| 200 | 19.14 | 22.91 | 21.10 | 22.67 | 27.57 | 33.99 | 27.11 |
| 300 | 18.99 | 22.64 | 20.86 | 22.37 | 27.02 | 35.68 | 27.54 |
| 400 | 18.74 | 22.31 | 20.64 | 22.16 | 26.81 | 36.50 | 28.23 |
| 500 | 18.60 | 22.13 | 20.54 | 22.11 | 26.83 | 36.28 | 27.83 |
| 600 | 18.50 | 22.03 | 20.52 | 22.17 | 27.09 | 35.06 | 26.64 |
| 700 | 18.63 | 22.28 | 20.76 | 22.51 | 27.82 | 33.28 | 26.82 |
| 800 | 18.82 | 22.60 | 21.03 | 22.85 | 28.51 | 32.30 | 27.65 |
| 900 | 19.14 | 23.08 | 21.39 | 23.28 | 29.27 | 31.38 | 27.67 |
| 1000 | 19.47 | 23.56 | 21.75 | 23.65 | 29.87 | 30.72 | 27.58 |
| 1100 | 19.47 | 23.56 | 21.74 | 23.62 | 29.70 | 30.63 | 27.99 |
| 1200 | 19.42 | 23.50 | 21.68 | 23.56 | 29.53 | 30.42 | 28.45 |
| 1300 | 19.10 | 22.93 | 21.17 | 22.85 | 27.81 | 30.76 | 29.90 |
| 1400 | 19.04 | 22.64 | 20.80 | 22.22 | 26.41 | 31.56 | 32.21 |
| 1500 | 18.96 | 22.41 | 20.58 | 21.96 | 26.24 | 33.20 | 34.21 |
| 1600 | 19.10 | 22.52 | 20.63 | 21.99 | 26.44 | 33.96 | 34.55 |
| 1700 | 19.63 | 23.19 | 21.10 | 22.51 | 27.30 | 32.52 | 32.15 |
| 1800 | 19.77 | 23.22 | 21.05 | 22.36 | 26.99 | 32.32 | 27.65 |
| 1900 | 20.27 | 23.59 | 21.25 | 22.45 | 27.27 | 33.44 | 24.00 |
| 2000 | 20.38 | 23.44 | 21.20 | 22.40 | 27.56 | 33.79 | 21.37 |
| 2100 | 20.58 | 23.35 | 21.28 | 22.54 | 28.24 | 33.37 | 19.50 |
| 2200 | 20.80 | 23.31 | 21.39 | 22.68 | 28.81 | 32.78 | 17.87 |
| 2300 | 20.54 | 22.35 | 21.01 | 22.32 | 28.65 | 33.37 | 15.93 |
| 2400 | 19.79 | 21.03 | 20.44 | 21.97 | 28.90 | 30.71 | 14.19 |
| 2500 | 19.53 | 20.64 | 20.32 | 22.03 | 29.41 | 28.94 | 13.45 |
| 2600 | 19.34 | 20.38 | 20.24 | 22.07 | 29.69 | 27.68 | 12.77 |
| 2700 | 19.04 | 19.95 | 20.05 | 21.99 | 29.39 | 26.50 | 12.14 |
| 2800 | 18.58 | 19.37 | 19.68 | 21.70 | 28.53 | 25.41 | 11.61 |
| 2900 | 18.19 | 18.88 | 19.37 | 21.43 | 27.46 | 24.16 | 11.28 |
| 3000 | 17.91 | 18.50 | 19.12 | 21.17 | 26.40 | 23.10 | 11.12 |
| 3200 | 17.35 | 17.76 | 18.59 | 20.53 | 24.02 | 20.97 | 10.83 |
| 3400 | 16.87 | 16.97 | 17.98 | 19.45 | 20.80 | 18.23 | 10.58 |
| 3600 | 16.85 | 16.58 | 17.64 | 18.48 | 18.28 | 15.97 | 10.18 |
| 3800 | 17.28 | 16.50 | 17.45 | 17.55 | 16.33 | 14.18 | 9.89 |
| 4000 | 17.21 | 16.26 | 16.98 | 16.76 | 15.28 | 13.20 | 9.53 |
| 4200 | 17.95 | 17.18 | 17.80 | 17.52 | 15.63 | 13.13 | 9.30 |
| 4400 | 19.66 | 18.89 | 19.56 | 19.00 | 16.12 | 13.10 | 9.51 |
| 4600 | 23.39 | 20.66 | 21.61 | 19.57 | 15.45 | 12.40 | 10.06 |
| 4800 | 32.54 | 21.28 | 22.66 | 18.82 | 14.19 | 11.37 | 10.74 |
| 5000 | 26.50 | 19.91 | 21.11 | 17.51 | 13.17 | 10.61 | 11.23 |

Notes

- A. Performance and quality attributes and conditions not expressly stated in this specification document are intended to be excluded and do not form a part of this specification document.
- B. Electrical specifications and performance data contained in this specification document are based on Mini-Circuit's applicable established test performance criteria and measurement instructions.
- C. The parts covered by this specification document are subject to Mini-Circuit's standard limited warranty and terms and conditions (collectively, "Standard Terms"). Purchasers of this part are entitled to the rights and benefits contained therein. For a full statement of the Standard Terms and the exclusive rights and remedies thereunder, please visit Mini-Circuit's website at www.minicircuits.com/MC_Store/terms.jsp



Digital Step Attenuator

ZX76-31A-PN+

Typical Performance Data

TEST CONDITIONS: INPUT POWER=0 dBm, Vdd=+3V, TEMPERATURE=-40°C

| FREQUENCY (MHz) | OUTPUT RETURN LOSS AT TTL CONTROL STATE (dB) | | | | | | |
|--------------------|---|------------------|------------------|------------------|------------------|-----------------|-----------------|
| | 000000 0 dB | 000010 1.0 dB | 000100 2.0 dB | 001000 4.0 dB | 010000 8.0 dB | 100000 16 dB | 111110 31 dB |
| 0.1 | 19.19 | 20.53 | 27.37 | 35.22 | 48.10 | 48.33 | 25.46 |
| 0.3 | 19.17 | 20.52 | 27.34 | 35.16 | 48.87 | 48.02 | 25.47 |
| 0.5 | 19.08 | 20.41 | 27.18 | 34.80 | 50.78 | 46.21 | 25.46 |
| 1 | 19.08 | 20.41 | 27.20 | 34.74 | 51.32 | 45.35 | 25.48 |
| 5 | 18.93 | 20.27 | 26.92 | 34.21 | 51.57 | 44.21 | 25.48 |
| 10 | 18.91 | 20.24 | 26.87 | 34.12 | 51.56 | 43.85 | 25.48 |
| 50 | 18.89 | 20.20 | 26.75 | 33.73 | 49.89 | 42.30 | 25.47 |
| 100 | 18.91 | 20.19 | 26.64 | 33.28 | 48.25 | 40.34 | 25.46 |
| 200 | 18.78 | 20.01 | 26.19 | 32.18 | 45.91 | 37.67 | 25.51 |
| 300 | 18.91 | 20.09 | 26.24 | 31.97 | 44.71 | 37.02 | 26.01 |
| 400 | 19.00 | 20.19 | 26.40 | 32.12 | 43.08 | 37.82 | 26.77 |
| 500 | 19.26 | 20.49 | 26.88 | 32.72 | 41.69 | 39.68 | 25.54 |
| 600 | 19.40 | 20.69 | 27.32 | 33.61 | 41.22 | 43.58 | 25.35 |
| 700 | 19.47 | 20.81 | 27.75 | 34.96 | 42.40 | 52.65 | 25.60 |
| 800 | 19.33 | 20.69 | 27.63 | 35.34 | 44.99 | 48.38 | 26.30 |
| 900 | 19.17 | 20.53 | 27.37 | 35.07 | 47.10 | 43.23 | 26.70 |
| 1000 | 18.98 | 20.32 | 26.94 | 34.20 | 48.26 | 40.13 | 26.05 |
| 1100 | 18.80 | 20.13 | 26.54 | 33.36 | 49.96 | 39.28 | 27.19 |
| 1200 | 18.87 | 20.19 | 26.65 | 33.52 | 50.40 | 39.30 | 27.90 |
| 1300 | 19.05 | 20.29 | 26.66 | 33.01 | 40.61 | 34.47 | 29.74 |
| 1400 | 19.07 | 20.14 | 26.12 | 31.20 | 38.69 | 32.53 | 29.75 |
| 1500 | 19.52 | 20.49 | 26.56 | 31.22 | 41.55 | 33.73 | 28.88 |
| 1600 | 19.56 | 20.45 | 26.38 | 30.67 | 40.21 | 32.60 | 28.36 |
| 1700 | 19.35 | 20.18 | 25.91 | 29.88 | 38.43 | 31.64 | 25.67 |
| 1800 | 19.32 | 20.03 | 25.42 | 28.66 | 35.92 | 30.93 | 22.57 |
| 1900 | 18.86 | 19.44 | 24.26 | 26.89 | 32.87 | 29.77 | 20.23 |
| 2000 | 18.69 | 19.19 | 23.66 | 25.90 | 32.13 | 30.55 | 18.77 |
| 2100 | 18.41 | 18.85 | 22.94 | 24.82 | 30.83 | 31.01 | 17.47 |
| 2200 | 18.00 | 18.40 | 22.12 | 23.78 | 29.46 | 30.89 | 16.33 |
| 2300 | 17.22 | 17.53 | 20.54 | 21.84 | 26.69 | 30.61 | 15.09 |
| 2400 | 16.71 | 17.00 | 19.40 | 20.41 | 24.87 | 31.25 | 14.34 |
| 2500 | 16.58 | 16.87 | 19.05 | 19.98 | 24.31 | 31.09 | 13.99 |
| 2600 | 16.44 | 16.74 | 18.73 | 19.61 | 23.78 | 30.27 | 13.70 |
| 2700 | 16.26 | 16.54 | 18.32 | 19.11 | 23.02 | 28.69 | 13.48 |
| 2800 | 16.04 | 16.32 | 17.85 | 18.55 | 22.15 | 26.83 | 13.19 |
| 2900 | 15.93 | 16.21 | 17.54 | 18.16 | 21.48 | 25.29 | 12.80 |
| 3000 | 15.75 | 16.04 | 17.22 | 17.79 | 20.89 | 23.98 | 12.45 |
| 3200 | 15.54 | 15.86 | 16.69 | 17.08 | 19.53 | 21.27 | 11.75 |
| 3400 | 15.77 | 16.06 | 16.47 | 16.60 | 18.32 | 19.02 | 11.40 |
| 3600 | 17.01 | 17.13 | 16.84 | 16.51 | 17.23 | 16.98 | 11.26 |
| 3800 | 19.28 | 19.17 | 17.74 | 16.82 | 16.49 | 15.54 | 11.14 |
| 4000 | 21.40 | 20.71 | 17.75 | 16.42 | 15.34 | 14.11 | 10.83 |
| 4200 | 21.67 | 20.41 | 16.83 | 15.47 | 14.11 | 12.79 | 11.23 |
| 4400 | 22.56 | 20.86 | 16.59 | 15.13 | 13.45 | 12.01 | 11.46 |
| 4600 | 25.28 | 22.35 | 16.80 | 15.07 | 12.90 | 11.32 | 11.75 |
| 4800 | 25.62 | 22.89 | 17.02 | 15.15 | 12.55 | 10.86 | 12.16 |
| 5000 | 21.48 | 20.46 | 16.23 | 14.59 | 11.90 | 10.23 | 12.51 |

Notes

- A. Performance and quality attributes and conditions not expressly stated in this specification document are intended to be excluded and do not form a part of this specification document.
- B. Electrical specifications and performance data contained in this specification document are based on Mini-Circuits' applicable established test performance criteria and measurement instructions.
- C. The parts covered by this specification document are subject to Mini-Circuits' standard limited warranty and terms and conditions (collectively, "Standard Terms"). Purchasers of this part are entitled to the rights and benefits contained therein. For a full statement of the Standard Terms and the exclusive rights and remedies thereunder, please visit Mini-Circuits' website at www.minicircuits.com/MC_Store/terms.jsp



Digital Step Attenuator

ZX76-31A-PN+

Typical Performance Data

TEST CONDITIONS: INPUT POWER=0 dBm, Vdd=+3V, TEMPERATURE=+25°C

| FREQUENCY (MHz) | STEP ATTENUATION* AT TTL CONTROL STATE | | | | | | |
|--------------------|--|------------------|------------------|------------------|------------------|-----------------|-----------------|
| | (dB) | | | | | | |
| | 000000 THRU LOSS | 000010 1.0 dB | 000100 2.0 dB | 001000 4.0 dB | 010000 8.0 dB | 100000 16 dB | 111110 31 dB |
| 0.1 | 1.21 | 1.01 | 2.01 | 4.00 | 7.97 | 15.85 | 30.77 |
| 0.3 | 1.22 | 1.01 | 2.01 | 4.00 | 7.97 | 15.85 | 30.78 |
| 0.5 | 1.22 | 1.01 | 2.01 | 4.00 | 7.97 | 15.85 | 30.77 |
| 1 | 1.23 | 1.01 | 2.01 | 4.00 | 7.97 | 15.85 | 30.78 |
| 5 | 1.23 | 1.01 | 2.01 | 4.00 | 7.97 | 15.85 | 30.79 |
| 10 | 1.24 | 1.01 | 2.01 | 4.00 | 7.97 | 15.85 | 30.79 |
| 50 | 1.25 | 1.01 | 2.01 | 4.00 | 7.97 | 15.85 | 30.79 |
| 100 | 1.27 | 1.01 | 2.01 | 4.00 | 7.97 | 15.85 | 30.78 |
| 200 | 1.31 | 1.01 | 2.01 | 4.00 | 7.97 | 15.85 | 30.77 |
| 300 | 1.34 | 1.01 | 2.01 | 4.00 | 7.97 | 15.85 | 30.76 |
| 400 | 1.38 | 1.01 | 2.00 | 3.99 | 7.97 | 15.85 | 30.77 |
| 500 | 1.42 | 1.01 | 2.00 | 3.99 | 7.97 | 15.85 | 30.75 |
| 600 | 1.46 | 1.00 | 2.00 | 3.99 | 7.97 | 15.85 | 30.75 |
| 700 | 1.49 | 1.00 | 2.00 | 3.99 | 7.97 | 15.85 | 30.75 |
| 800 | 1.54 | 1.00 | 2.00 | 3.99 | 7.97 | 15.86 | 30.76 |
| 900 | 1.57 | 1.00 | 1.99 | 3.98 | 7.97 | 15.86 | 30.76 |
| 1000 | 1.61 | 1.00 | 1.99 | 3.98 | 7.98 | 15.87 | 30.77 |
| 1100 | 1.65 | 1.00 | 1.99 | 3.98 | 7.98 | 15.88 | 30.76 |
| 1200 | 1.69 | 1.00 | 1.99 | 3.98 | 7.99 | 15.88 | 30.75 |
| 1300 | 1.73 | 1.00 | 1.99 | 3.98 | 7.99 | 15.89 | 30.75 |
| 1400 | 1.77 | 1.00 | 1.99 | 3.98 | 8.00 | 15.90 | 30.79 |
| 1500 | 1.81 | 1.00 | 1.99 | 3.98 | 8.00 | 15.91 | 30.84 |
| 1600 | 1.85 | 1.00 | 1.99 | 3.98 | 8.01 | 15.92 | 30.89 |
| 1700 | 1.89 | 1.00 | 1.99 | 3.98 | 8.01 | 15.93 | 30.94 |
| 1800 | 1.93 | 1.00 | 1.99 | 3.98 | 8.02 | 15.94 | 30.98 |
| 1900 | 1.98 | 1.00 | 1.99 | 3.98 | 8.02 | 15.95 | 31.01 |
| 2000 | 2.02 | 1.00 | 1.99 | 3.98 | 8.02 | 15.95 | 31.02 |
| 2100 | 2.07 | 1.00 | 1.99 | 3.98 | 8.02 | 15.96 | 31.00 |
| 2200 | 2.11 | 1.00 | 1.99 | 3.97 | 8.03 | 15.97 | 30.42 |
| 2300 | 2.15 | 1.00 | 1.99 | 3.97 | 8.03 | 15.98 | 30.55 |
| 2400 | 2.19 | 1.00 | 2.00 | 3.97 | 8.04 | 16.00 | 31.04 |
| 2500 | 2.23 | 1.00 | 2.00 | 3.97 | 8.05 | 16.03 | 31.53 |
| 2600 | 2.26 | 1.01 | 2.00 | 3.98 | 8.06 | 16.05 | 32.10 |
| 2700 | 2.29 | 1.01 | 2.00 | 3.98 | 8.08 | 16.08 | 32.58 |
| 2800 | 2.32 | 1.01 | 2.01 | 3.98 | 8.10 | 16.12 | 32.50 |
| 2900 | 2.35 | 1.02 | 2.01 | 3.99 | 8.12 | 16.17 | 31.83 |
| 3000 | 2.37 | 1.02 | 2.02 | 4.00 | 8.15 | 16.22 | 31.16 |
| 3200 | 2.41 | 1.03 | 2.04 | 4.03 | 8.23 | 16.35 | 30.79 |
| 3400 | 2.43 | 1.05 | 2.07 | 4.07 | 8.34 | 16.51 | 31.10 |
| 3600 | 2.44 | 1.07 | 2.10 | 4.13 | 8.46 | 16.68 | 31.56 |
| 3800 | 2.46 | 1.08 | 2.13 | 4.17 | 8.57 | 16.76 | 31.83 |
| 4000 | 2.52 | 1.08 | 2.15 | 4.20 | 8.69 | 16.95 | 31.74 |
| 4200 | 2.67 | 1.08 | 2.16 | 4.23 | 8.81 | 17.17 | 30.48 |
| 4400 | 2.93 | 1.07 | 2.16 | 4.25 | 8.93 | 17.46 | 30.31 |
| 4600 | 3.14 | 1.08 | 2.18 | 4.28 | 9.07 | 17.78 | 29.57 |
| 4800 | 3.12 | 1.09 | 2.18 | 4.29 | 9.17 | 17.95 | 28.61 |
| 5000 | 3.11 | 1.07 | 2.14 | 4.24 | 9.22 | 18.09 | 27.63 |

* Step Attenuation above Thru Loss (TTL Logic 00000).

Notes

- A. Performance and quality attributes and conditions not expressly stated in this specification document are intended to be excluded and do not form a part of this specification document.
- B. Electrical specifications and performance data contained in this specification document are based on Mini-Circuits' applicable established test performance criteria and measurement instructions.
- C. The parts covered by this specification document are subject to Mini-Circuits' standard limited warranty and terms and conditions (collectively, "Standard Terms"); Purchasers of this part are entitled to the rights and benefits contained therein. For a full statement of the Standard Terms and the exclusive rights and remedies thereunder, please visit Mini-Circuits' website at www.minicircuits.com/MC_Store/terms.jsp



Digital Step Attenuator

ZX76-31A-PN+

Typical Performance Data

TEST CONDITIONS: INPUT POWER=0 dBm, Vdd=+3V, TEMPERATURE=+25°C

| FREQUENCY (MHz) | INPUT RETURN LOSS AT TTL CONTROL STATE (dB) | | | | | | |
|--------------------|--|------------------|------------------|------------------|------------------|-----------------|-----------------|
| | 000000 0 dB | 000010 1.0 dB | 000100 2.0 dB | 001000 4.0 dB | 010000 8.0 dB | 100000 16 dB | 111110 31 dB |
| 0.1 | 18.79 | 21.87 | 19.97 | 21.00 | 24.11 | 43.54 | 42.52 |
| 0.3 | 18.77 | 21.84 | 19.96 | 20.99 | 24.08 | 43.26 | 42.60 |
| 0.5 | 18.76 | 21.83 | 19.90 | 20.88 | 23.85 | 42.07 | 42.57 |
| 1 | 18.66 | 21.75 | 19.81 | 20.79 | 23.77 | 41.88 | 42.64 |
| 5 | 18.56 | 21.64 | 19.74 | 20.75 | 23.75 | 41.62 | 42.98 |
| 10 | 18.54 | 21.62 | 19.72 | 20.73 | 23.73 | 41.56 | 42.89 |
| 50 | 18.55 | 21.62 | 19.73 | 20.73 | 23.72 | 41.22 | 43.39 |
| 100 | 18.57 | 21.63 | 19.74 | 20.74 | 23.72 | 40.92 | 43.49 |
| 200 | 18.59 | 21.66 | 19.77 | 20.78 | 23.77 | 40.26 | 43.48 |
| 300 | 18.64 | 21.69 | 19.79 | 20.76 | 23.70 | 38.56 | 43.14 |
| 400 | 18.58 | 21.61 | 19.73 | 20.70 | 23.60 | 37.38 | 42.97 |
| 500 | 18.59 | 21.60 | 19.72 | 20.68 | 23.53 | 36.24 | 40.56 |
| 600 | 18.53 | 21.51 | 19.65 | 20.59 | 23.39 | 35.17 | 38.09 |
| 700 | 18.54 | 21.51 | 19.64 | 20.58 | 23.35 | 34.55 | 35.20 |
| 800 | 18.53 | 21.49 | 19.63 | 20.56 | 23.28 | 33.81 | 33.08 |
| 900 | 18.59 | 21.54 | 19.66 | 20.56 | 23.23 | 33.01 | 31.20 |
| 1000 | 18.60 | 21.51 | 19.63 | 20.49 | 23.06 | 31.95 | 29.43 |
| 1100 | 18.45 | 21.32 | 19.48 | 20.32 | 22.83 | 31.20 | 28.47 |
| 1200 | 18.44 | 21.29 | 19.44 | 20.26 | 22.73 | 30.74 | 27.59 |
| 1300 | 18.21 | 20.87 | 19.05 | 19.74 | 21.82 | 27.94 | 26.73 |
| 1400 | 18.09 | 20.60 | 18.75 | 19.30 | 21.07 | 26.22 | 25.91 |
| 1500 | 18.15 | 20.56 | 18.61 | 19.03 | 20.58 | 25.07 | 25.50 |
| 1600 | 18.11 | 20.38 | 18.36 | 18.64 | 20.01 | 24.08 | 25.04 |
| 1700 | 18.16 | 20.28 | 18.17 | 18.34 | 19.58 | 23.42 | 24.39 |
| 1800 | 17.98 | 19.90 | 17.82 | 17.94 | 19.18 | 23.07 | 23.80 |
| 1900 | 18.03 | 19.75 | 17.70 | 17.77 | 19.05 | 23.03 | 22.99 |
| 2000 | 17.60 | 19.05 | 17.24 | 17.36 | 18.73 | 22.78 | 21.51 |
| 2100 | 16.90 | 18.08 | 16.65 | 16.86 | 18.38 | 22.51 | 19.93 |
| 2200 | 16.33 | 17.27 | 16.23 | 16.59 | 18.37 | 22.81 | 18.70 |
| 2300 | 15.93 | 16.71 | 16.03 | 16.57 | 18.71 | 23.65 | 16.83 |
| 2400 | 15.47 | 16.12 | 15.79 | 16.55 | 19.11 | 24.59 | 15.03 |
| 2500 | 14.99 | 15.56 | 15.43 | 16.28 | 19.00 | 24.38 | 14.24 |
| 2600 | 14.73 | 15.24 | 15.28 | 16.22 | 19.14 | 24.49 | 13.58 |
| 2700 | 14.46 | 14.91 | 15.11 | 16.15 | 19.22 | 24.32 | 13.03 |
| 2800 | 14.41 | 14.78 | 15.16 | 16.30 | 19.58 | 24.24 | 12.57 |
| 2900 | 14.20 | 14.52 | 15.04 | 16.25 | 19.57 | 23.44 | 12.25 |
| 3000 | 14.15 | 14.40 | 15.05 | 16.33 | 19.67 | 22.72 | 12.04 |
| 3200 | 14.14 | 14.27 | 15.15 | 16.50 | 19.59 | 20.95 | 11.69 |
| 3400 | 13.84 | 13.79 | 14.80 | 15.96 | 18.09 | 18.19 | 11.48 |
| 3600 | 13.76 | 13.54 | 14.57 | 15.47 | 16.70 | 16.21 | 11.22 |
| 3800 | 13.84 | 13.41 | 14.37 | 14.90 | 15.22 | 14.34 | 10.86 |
| 4000 | 13.77 | 13.30 | 14.15 | 14.51 | 14.49 | 13.43 | 10.74 |
| 4200 | 14.90 | 14.12 | 15.01 | 15.08 | 14.38 | 12.78 | 10.79 |
| 4400 | 17.09 | 15.50 | 16.56 | 16.02 | 14.28 | 12.22 | 11.51 |
| 4600 | 21.93 | 17.97 | 19.40 | 17.50 | 14.24 | 11.79 | 12.48 |
| 4800 | 24.89 | 18.59 | 19.88 | 17.09 | 13.37 | 11.02 | 13.27 |
| 5000 | 22.12 | 17.97 | 18.84 | 16.24 | 12.62 | 10.42 | 12.84 |

Notes

- A. Performance and quality attributes and conditions not expressly stated in this specification document are intended to be excluded and do not form a part of this specification document.
- B. Electrical specifications and performance data contained in this specification document are based on Mini-Circuit's applicable established test performance criteria and measurement instructions.
- C. The parts covered by this specification document are subject to Mini-Circuit's standard limited warranty and terms and conditions (collectively, "Standard Terms"). Purchasers of this part are entitled to the rights and benefits contained therein. For a full statement of the Standard Terms and the exclusive rights and remedies thereunder, please visit Mini-Circuit's website at www.minicircuits.com/MC_Store/terms.jsp



Digital Step Attenuator

ZX76-31A-PN+

Typical Performance Data

TEST CONDITIONS: INPUT POWER=0 dBm, Vdd=+3V, TEMPERATURE=+25°C

| FREQUENCY (MHz) | OUTPUT RETURN LOSS AT TTL CONTROL STATE (dB) | | | | | | |
|--------------------|---|------------------|------------------|------------------|------------------|-----------------|-----------------|
| | 000000 0 dB | 000010 1.0 dB | 000100 2.0 dB | 001000 4.0 dB | 010000 8.0 dB | 100000 16 dB | 111110 31 dB |
| 0.1 | 18.63 | 19.43 | 24.48 | 28.24 | 32.18 | 28.59 | 47.11 |
| 0.3 | 18.62 | 19.42 | 24.47 | 28.22 | 32.16 | 28.58 | 47.32 |
| 0.5 | 18.52 | 19.32 | 24.32 | 27.99 | 31.69 | 28.19 | 47.29 |
| 1 | 18.51 | 19.30 | 24.34 | 27.99 | 31.68 | 28.14 | 47.23 |
| 5 | 18.41 | 19.22 | 24.21 | 27.88 | 31.63 | 28.17 | 47.18 |
| 10 | 18.39 | 19.21 | 24.20 | 27.86 | 31.61 | 28.16 | 47.70 |
| 50 | 18.42 | 19.24 | 24.24 | 27.90 | 31.66 | 28.19 | 47.27 |
| 100 | 18.52 | 19.33 | 24.35 | 28.02 | 31.76 | 28.24 | 47.09 |
| 200 | 18.49 | 19.30 | 24.30 | 27.94 | 31.64 | 28.17 | 47.13 |
| 300 | 18.54 | 19.34 | 24.31 | 27.88 | 31.38 | 27.97 | 47.03 |
| 400 | 18.42 | 19.22 | 24.10 | 27.58 | 30.96 | 27.69 | 45.60 |
| 500 | 18.53 | 19.32 | 24.22 | 27.69 | 30.98 | 27.66 | 56.03 |
| 600 | 18.55 | 19.33 | 24.22 | 27.66 | 30.82 | 27.55 | 56.93 |
| 700 | 18.51 | 19.28 | 24.10 | 27.46 | 30.44 | 27.27 | 60.30 |
| 800 | 18.50 | 19.27 | 24.06 | 27.37 | 30.24 | 27.11 | 47.75 |
| 900 | 18.49 | 19.25 | 24.00 | 27.23 | 29.92 | 26.86 | 40.87 |
| 1000 | 18.49 | 19.23 | 23.92 | 27.04 | 29.56 | 26.56 | 36.47 |
| 1100 | 18.47 | 19.21 | 23.87 | 26.96 | 29.35 | 26.39 | 32.95 |
| 1200 | 18.46 | 19.17 | 23.77 | 26.75 | 28.93 | 26.04 | 30.03 |
| 1300 | 18.43 | 19.05 | 23.40 | 25.97 | 27.52 | 24.83 | 27.66 |
| 1400 | 18.39 | 18.89 | 22.97 | 25.11 | 26.12 | 23.59 | 25.71 |
| 1500 | 18.34 | 18.72 | 22.59 | 24.36 | 25.04 | 22.65 | 23.94 |
| 1600 | 18.40 | 18.61 | 22.30 | 23.71 | 24.18 | 21.93 | 22.45 |
| 1700 | 18.46 | 18.51 | 22.00 | 23.04 | 23.42 | 21.38 | 21.09 |
| 1800 | 18.58 | 18.45 | 21.69 | 22.41 | 22.87 | 21.08 | 19.86 |
| 1900 | 18.33 | 18.09 | 21.00 | 21.52 | 22.19 | 20.81 | 18.71 |
| 2000 | 18.20 | 17.86 | 20.45 | 20.84 | 21.81 | 20.87 | 17.69 |
| 2100 | 17.83 | 17.49 | 19.67 | 20.05 | 21.47 | 21.17 | 16.81 |
| 2200 | 17.11 | 16.87 | 18.66 | 19.11 | 21.03 | 21.57 | 16.09 |
| 2300 | 16.41 | 16.28 | 17.75 | 18.29 | 20.67 | 22.22 | 15.47 |
| 2400 | 15.72 | 15.72 | 16.89 | 17.52 | 20.32 | 23.12 | 14.98 |
| 2500 | 15.20 | 15.30 | 16.34 | 17.04 | 20.03 | 23.40 | 14.76 |
| 2600 | 14.80 | 14.97 | 15.91 | 16.67 | 19.79 | 23.69 | 14.54 |
| 2700 | 14.49 | 14.72 | 15.57 | 16.35 | 19.60 | 23.93 | 14.30 |
| 2800 | 14.20 | 14.49 | 15.28 | 16.08 | 19.41 | 24.03 | 14.05 |
| 2900 | 14.01 | 14.34 | 15.05 | 15.85 | 19.21 | 23.89 | 13.71 |
| 3000 | 13.84 | 14.21 | 14.84 | 15.64 | 18.99 | 23.47 | 13.40 |
| 3200 | 13.83 | 14.25 | 14.70 | 15.43 | 18.63 | 22.22 | 12.86 |
| 3400 | 14.11 | 14.57 | 14.82 | 15.45 | 18.35 | 20.66 | 12.55 |
| 3600 | 15.04 | 15.47 | 15.34 | 15.71 | 17.97 | 18.91 | 12.31 |
| 3800 | 16.46 | 16.82 | 16.02 | 16.03 | 17.36 | 17.14 | 12.15 |
| 4000 | 17.39 | 17.64 | 16.09 | 15.76 | 16.18 | 15.31 | 12.10 |
| 4200 | 18.27 | 18.28 | 16.04 | 15.41 | 15.13 | 13.89 | 12.55 |
| 4400 | 20.26 | 19.89 | 16.55 | 15.52 | 14.51 | 12.95 | 13.29 |
| 4600 | 25.03 | 22.99 | 17.41 | 15.83 | 13.96 | 12.16 | 14.31 |
| 4800 | 27.89 | 24.21 | 17.70 | 15.80 | 13.28 | 11.37 | 15.02 |
| 5000 | 22.61 | 21.47 | 17.10 | 15.42 | 12.68 | 10.79 | 15.11 |

Notes

- A. Performance and quality attributes and conditions not expressly stated in this specification document are intended to be excluded and do not form a part of this specification document.
- B. Electrical specifications and performance data contained in this specification document are based on Mini-Circuits' applicable established test performance criteria and measurement instructions.
- C. The parts covered by this specification document are subject to Mini-Circuits' standard limited warranty and terms and conditions (collectively, "Standard Terms"); Purchasers of this part are entitled to the rights and benefits contained therein. For a full statement of the Standard Terms and the exclusive rights and remedies thereunder, please visit Mini-Circuits' website at www.minicircuits.com/MC_Store/terms.jsp



Digital Step Attenuator

ZX76-31A-PN+

Typical Performance Data

TEST CONDITIONS: INPUT POWER=0 dBm, Vdd=+3V, TEMPERATURE=+85°C

| FREQUENCY (MHz) | STEP ATTENUATION* AT TTL CONTROL STATE (dB) | | | | | | |
|--------------------|--|------------------|------------------|------------------|------------------|-----------------|-----------------|
| | 000000 THRU LOSS | 000010 1.0 dB | 000100 2.0 dB | 001000 4.0 dB | 010000 8.0 dB | 100000 16 dB | 111110 31 dB |
| 0.1 | 1.22 | 1.02 | 2.01 | 4.00 | 7.92 | 15.89 | 30.61 |
| 0.3 | 1.23 | 1.02 | 2.01 | 4.00 | 7.92 | 15.89 | 30.61 |
| 0.5 | 1.25 | 1.02 | 2.01 | 3.99 | 7.90 | 15.87 | 30.61 |
| 1 | 1.27 | 1.02 | 2.01 | 3.99 | 7.89 | 15.86 | 30.62 |
| 5 | 1.26 | 1.02 | 2.01 | 3.99 | 7.90 | 15.86 | 30.63 |
| 10 | 1.26 | 1.02 | 2.01 | 3.99 | 7.90 | 15.86 | 30.63 |
| 50 | 1.26 | 1.02 | 2.01 | 3.99 | 7.90 | 15.86 | 30.62 |
| 100 | 1.26 | 1.02 | 2.01 | 3.99 | 7.90 | 15.86 | 30.62 |
| 200 | 1.30 | 1.02 | 2.01 | 3.99 | 7.90 | 15.87 | 30.61 |
| 300 | 1.29 | 1.02 | 2.01 | 3.99 | 7.90 | 15.86 | 30.61 |
| 400 | 1.31 | 1.02 | 2.01 | 4.00 | 7.90 | 15.87 | 30.62 |
| 500 | 1.34 | 1.02 | 2.01 | 3.99 | 7.90 | 15.87 | 30.61 |
| 600 | 1.34 | 1.02 | 2.01 | 3.99 | 7.90 | 15.86 | 30.60 |
| 700 | 1.38 | 1.02 | 2.01 | 3.99 | 7.90 | 15.87 | 30.61 |
| 800 | 1.38 | 1.02 | 2.01 | 3.99 | 7.90 | 15.86 | 30.62 |
| 900 | 1.41 | 1.02 | 2.01 | 3.99 | 7.90 | 15.86 | 30.64 |
| 1000 | 1.43 | 1.02 | 2.01 | 3.99 | 7.90 | 15.87 | 30.66 |
| 1100 | 1.43 | 1.02 | 2.01 | 3.99 | 7.90 | 15.86 | 30.68 |
| 1200 | 1.47 | 1.02 | 2.01 | 3.99 | 7.90 | 15.87 | 30.69 |
| 1300 | 1.56 | 1.02 | 2.01 | 3.99 | 7.91 | 15.88 | 30.72 |
| 1400 | 1.65 | 1.02 | 2.01 | 3.99 | 7.92 | 15.90 | 30.77 |
| 1500 | 1.74 | 1.02 | 2.01 | 3.99 | 7.93 | 15.92 | 30.85 |
| 1600 | 1.83 | 1.02 | 2.01 | 4.00 | 7.95 | 15.94 | 30.92 |
| 1700 | 1.92 | 1.02 | 2.01 | 4.00 | 7.96 | 15.96 | 31.00 |
| 1800 | 2.01 | 1.02 | 2.02 | 4.01 | 7.98 | 15.99 | 31.08 |
| 1900 | 2.10 | 1.02 | 2.02 | 4.01 | 8.00 | 16.02 | 31.13 |
| 2000 | 2.20 | 1.02 | 2.02 | 4.01 | 8.02 | 16.05 | 31.15 |
| 2100 | 2.29 | 1.02 | 2.03 | 4.02 | 8.04 | 16.09 | 31.05 |
| 2200 | 2.38 | 1.03 | 2.03 | 4.02 | 8.06 | 16.13 | 30.61 |
| 2300 | 2.47 | 1.03 | 2.04 | 4.02 | 8.09 | 16.17 | 30.98 |
| 2400 | 2.55 | 1.03 | 2.04 | 4.02 | 8.11 | 16.22 | 31.60 |
| 2500 | 2.59 | 1.03 | 2.04 | 4.02 | 8.12 | 16.24 | 32.13 |
| 2600 | 2.64 | 1.03 | 2.04 | 4.03 | 8.14 | 16.27 | 32.63 |
| 2700 | 2.68 | 1.04 | 2.05 | 4.03 | 8.15 | 16.29 | 32.79 |
| 2800 | 2.72 | 1.04 | 2.05 | 4.03 | 8.17 | 16.32 | 32.35 |
| 2900 | 2.77 | 1.04 | 2.05 | 4.03 | 8.19 | 16.35 | 31.72 |
| 3000 | 2.82 | 1.04 | 2.06 | 4.03 | 8.21 | 16.36 | 31.24 |
| 3200 | 2.89 | 1.04 | 2.07 | 4.04 | 8.24 | 16.36 | 31.08 |
| 3400 | 3.00 | 1.04 | 2.09 | 4.05 | 8.30 | 16.45 | 31.40 |
| 3600 | 3.17 | 1.05 | 2.09 | 4.07 | 8.39 | 16.64 | 31.68 |
| 3800 | 3.38 | 1.06 | 2.12 | 4.13 | 8.53 | 16.96 | 31.83 |
| 4000 | 3.47 | 1.08 | 2.16 | 4.18 | 8.68 | 17.21 | 31.82 |
| 4200 | 3.36 | 1.11 | 2.20 | 4.24 | 8.83 | 17.40 | 31.01 |
| 4400 | 3.28 | 1.13 | 2.23 | 4.30 | 9.01 | 17.71 | 31.22 |
| 4600 | 3.32 | 1.13 | 2.25 | 4.34 | 9.18 | 18.01 | 30.41 |
| 4800 | 3.49 | 1.12 | 2.25 | 4.34 | 9.30 | 18.24 | 29.24 |
| 5000 | 3.74 | 1.10 | 2.23 | 4.33 | 9.40 | 18.41 | 28.11 |

* Step Attenuation above Thru Loss (TTL Logic 00000).

Notes

- A. Performance and quality attributes and conditions not expressly stated in this specification document are intended to be excluded and do not form a part of this specification document.
- B. Electrical specifications and performance data contained in this specification document are based on Mini-Circuits' applicable established test performance criteria and measurement instructions.
- C. The parts covered by this specification document are subject to Mini-Circuits' standard limited warranty and terms and conditions (collectively, "Standard Terms"); Purchasers of this part are entitled to the rights and benefits contained therein. For a full statement of the Standard Terms and the exclusive rights and remedies thereunder, please visit Mini-Circuits' website at www.minicircuits.com/MC_Store/terms.jsp



Digital Step Attenuator

ZX76-31A-PN+

Typical Performance Data

TEST CONDITIONS: INPUT POWER=0 dBm, Vdd=+3V, TEMPERATURE=+85°C

| FREQUENCY (MHz) | INPUT RETURN LOSS AT TTL CONTROL STATE (dB) | | | | | | |
|--------------------|--|------------------|------------------|------------------|------------------|-----------------|-----------------|
| | 000000 0 dB | 000010 1.0 dB | 000100 2.0 dB | 001000 4.0 dB | 010000 8.0 dB | 100000 16 dB | 111110 31 dB |
| 0.1 | 18.17 | 20.32 | 18.20 | 18.45 | 19.87 | 25.76 | 25.15 |
| 0.3 | 18.16 | 20.31 | 18.19 | 18.44 | 19.85 | 25.71 | 25.15 |
| 0.5 | 18.15 | 20.30 | 18.14 | 18.37 | 19.75 | 25.61 | 25.14 |
| 1 | 18.06 | 20.24 | 18.09 | 18.32 | 19.73 | 25.60 | 25.15 |
| 5 | 17.96 | 20.14 | 18.04 | 18.30 | 19.74 | 25.64 | 25.18 |
| 10 | 17.94 | 20.12 | 18.03 | 18.29 | 19.73 | 25.64 | 25.19 |
| 50 | 17.94 | 20.12 | 18.04 | 18.32 | 19.77 | 25.72 | 25.24 |
| 100 | 17.94 | 20.13 | 18.06 | 18.35 | 19.84 | 25.86 | 25.27 |
| 200 | 17.92 | 20.15 | 18.12 | 18.45 | 19.98 | 26.21 | 25.30 |
| 300 | 17.92 | 20.18 | 18.17 | 18.54 | 20.14 | 26.51 | 25.55 |
| 400 | 17.91 | 20.21 | 18.23 | 18.62 | 20.26 | 26.69 | 26.02 |
| 500 | 17.96 | 20.25 | 18.27 | 18.63 | 20.20 | 26.35 | 26.15 |
| 600 | 17.96 | 20.21 | 18.22 | 18.54 | 20.05 | 25.86 | 25.03 |
| 700 | 17.97 | 20.18 | 18.18 | 18.46 | 19.90 | 25.36 | 24.55 |
| 800 | 17.87 | 20.01 | 18.02 | 18.27 | 19.61 | 24.69 | 23.77 |
| 900 | 17.85 | 19.93 | 17.93 | 18.15 | 19.42 | 24.28 | 22.98 |
| 1000 | 17.82 | 19.85 | 17.83 | 18.01 | 19.23 | 23.81 | 22.13 |
| 1100 | 17.67 | 19.62 | 17.63 | 17.81 | 18.98 | 23.38 | 21.47 |
| 1200 | 17.62 | 19.54 | 17.56 | 17.72 | 18.87 | 23.19 | 20.76 |
| 1300 | 17.58 | 19.35 | 17.32 | 17.37 | 18.31 | 22.00 | 20.03 |
| 1400 | 17.46 | 19.12 | 17.04 | 16.96 | 17.70 | 20.84 | 19.30 |
| 1500 | 17.47 | 19.02 | 16.84 | 16.64 | 17.23 | 20.04 | 18.80 |
| 1600 | 17.53 | 18.95 | 16.71 | 16.41 | 16.89 | 19.48 | 18.38 |
| 1700 | 17.65 | 18.93 | 16.65 | 16.27 | 16.68 | 19.13 | 18.04 |
| 1800 | 17.63 | 18.77 | 16.53 | 16.15 | 16.58 | 18.98 | 17.92 |
| 1900 | 17.47 | 18.43 | 16.34 | 15.96 | 16.45 | 18.82 | 17.91 |
| 2000 | 17.09 | 17.86 | 16.07 | 15.79 | 16.40 | 18.82 | 17.62 |
| 2100 | 16.65 | 17.26 | 15.81 | 15.66 | 16.44 | 18.99 | 17.13 |
| 2200 | 16.08 | 16.58 | 15.50 | 15.52 | 16.55 | 19.25 | 16.61 |
| 2300 | 15.42 | 15.81 | 15.12 | 15.33 | 16.66 | 19.56 | 15.33 |
| 2400 | 14.86 | 15.15 | 14.84 | 15.26 | 16.92 | 20.14 | 13.77 |
| 2500 | 14.65 | 14.90 | 14.77 | 15.31 | 17.19 | 20.62 | 13.05 |
| 2600 | 14.49 | 14.71 | 14.74 | 15.40 | 17.52 | 21.20 | 12.45 |
| 2700 | 14.37 | 14.55 | 14.74 | 15.52 | 17.91 | 21.85 | 11.93 |
| 2800 | 14.17 | 14.33 | 14.66 | 15.56 | 18.18 | 22.28 | 11.52 |
| 2900 | 13.95 | 14.07 | 14.56 | 15.57 | 18.42 | 22.55 | 11.19 |
| 3000 | 13.78 | 13.87 | 14.50 | 15.60 | 18.66 | 22.69 | 10.93 |
| 3200 | 13.65 | 13.62 | 14.56 | 15.81 | 19.05 | 22.09 | 10.38 |
| 3400 | 13.64 | 13.46 | 14.61 | 15.85 | 18.64 | 20.07 | 9.72 |
| 3600 | 13.68 | 13.32 | 14.53 | 15.62 | 17.54 | 17.84 | 8.79 |
| 3800 | 13.42 | 12.92 | 14.08 | 14.93 | 16.05 | 15.79 | 7.82 |
| 4000 | 13.27 | 12.72 | 13.81 | 14.45 | 15.07 | 14.39 | 7.80 |
| 4200 | 14.36 | 13.53 | 14.67 | 15.02 | 14.87 | 13.55 | 8.41 |
| 4400 | 16.94 | 15.27 | 16.71 | 16.38 | 14.84 | 12.85 | 9.54 |
| 4600 | 20.89 | 17.28 | 19.05 | 17.44 | 14.43 | 12.13 | 11.42 |
| 4800 | 23.44 | 18.32 | 19.65 | 17.21 | 13.62 | 11.37 | 14.06 |
| 5000 | 20.80 | 17.80 | 18.42 | 16.32 | 12.92 | 10.83 | 16.38 |

Notes

- A. Performance and quality attributes and conditions not expressly stated in this specification document are intended to be excluded and do not form a part of this specification document.
- B. Electrical specifications and performance data contained in this specification document are based on Mini-Circuits' applicable established test performance criteria and measurement instructions.
- C. The parts covered by this specification document are subject to Mini-Circuits' standard limited warranty and terms and conditions (collectively, "Standard Terms"). Purchasers of this part are entitled to the rights and benefits contained therein. For a full statement of the Standard Terms and the exclusive rights and remedies thereunder, please visit Mini-Circuits' website at www.minicircuits.com/MC_Store/terms.jsp



Digital Step Attenuator

ZX76-31A-PN+

Typical Performance Data

TEST CONDITIONS: INPUT POWER=0 dBm, Vdd=+3V, TEMPERATURE=+85°C

| FREQUENCY (MHz) | OUTPUT RETURN LOSS AT TTL CONTROL STATE (dB) | | | | | | |
|--------------------|---|------------------|------------------|------------------|------------------|-----------------|-----------------|
| | 000000 0 dB | 000010 1.0 dB | 000100 2.0 dB | 001000 4.0 dB | 010000 8.0 dB | 100000 16 dB | 111110 31 dB |
| 0.1 | 19.19 | 18.23 | 21.73 | 23.27 | 23.97 | 21.63 | 27.42 |
| 0.3 | 19.17 | 18.22 | 21.72 | 23.25 | 23.94 | 21.62 | 27.43 |
| 0.5 | 19.08 | 18.14 | 21.63 | 23.14 | 23.81 | 21.48 | 27.43 |
| 1 | 19.08 | 18.14 | 21.65 | 23.16 | 23.82 | 21.48 | 27.42 |
| 5 | 18.93 | 18.08 | 21.58 | 23.13 | 23.86 | 21.55 | 27.47 |
| 10 | 18.91 | 18.07 | 21.57 | 23.12 | 23.86 | 21.55 | 27.43 |
| 50 | 18.89 | 18.14 | 21.66 | 23.24 | 24.00 | 21.67 | 27.52 |
| 100 | 18.91 | 18.28 | 21.87 | 23.47 | 24.25 | 21.86 | 27.55 |
| 200 | 18.78 | 18.42 | 22.12 | 23.81 | 24.69 | 22.22 | 27.58 |
| 300 | 18.91 | 18.59 | 22.37 | 24.14 | 25.06 | 22.51 | 27.81 |
| 400 | 19.00 | 18.51 | 22.25 | 24.05 | 25.01 | 22.50 | 28.51 |
| 500 | 19.26 | 18.39 | 22.01 | 23.71 | 24.55 | 22.14 | 28.56 |
| 600 | 19.40 | 18.16 | 21.64 | 23.24 | 24.01 | 21.74 | 27.12 |
| 700 | 19.47 | 18.01 | 21.36 | 22.88 | 23.57 | 21.37 | 26.74 |
| 800 | 19.33 | 17.91 | 21.18 | 22.61 | 23.21 | 21.07 | 25.74 |
| 900 | 19.17 | 17.95 | 21.22 | 22.60 | 23.13 | 20.98 | 25.09 |
| 1000 | 18.98 | 17.99 | 21.23 | 22.56 | 23.02 | 20.86 | 24.33 |
| 1100 | 18.80 | 18.00 | 21.24 | 22.53 | 22.93 | 20.77 | 23.47 |
| 1200 | 18.87 | 18.09 | 21.34 | 22.60 | 22.92 | 20.72 | 22.45 |
| 1300 | 19.05 | 17.84 | 20.82 | 21.78 | 21.79 | 19.71 | 21.44 |
| 1400 | 19.07 | 17.69 | 20.50 | 21.18 | 20.93 | 18.93 | 20.37 |
| 1500 | 19.52 | 17.55 | 20.18 | 20.59 | 20.17 | 18.24 | 19.35 |
| 1600 | 19.56 | 17.49 | 19.96 | 20.13 | 19.63 | 17.80 | 18.44 |
| 1700 | 19.35 | 17.38 | 19.64 | 19.62 | 19.15 | 17.48 | 17.65 |
| 1800 | 19.32 | 17.19 | 19.23 | 19.10 | 18.78 | 17.32 | 16.95 |
| 1900 | 18.86 | 16.97 | 18.78 | 18.59 | 18.50 | 17.29 | 16.29 |
| 2000 | 18.69 | 16.72 | 18.27 | 18.12 | 18.35 | 17.46 | 15.72 |
| 2100 | 18.41 | 16.37 | 17.67 | 17.61 | 18.21 | 17.72 | 15.28 |
| 2200 | 18.00 | 15.98 | 17.05 | 17.11 | 18.16 | 18.19 | 14.95 |
| 2300 | 17.22 | 15.58 | 16.44 | 16.66 | 18.21 | 18.91 | 14.72 |
| 2400 | 16.71 | 15.15 | 15.85 | 16.23 | 18.32 | 19.88 | 14.56 |
| 2500 | 16.58 | 14.91 | 15.53 | 15.98 | 18.32 | 20.39 | 14.49 |
| 2600 | 16.44 | 14.66 | 15.21 | 15.73 | 18.32 | 20.95 | 14.40 |
| 2700 | 16.26 | 14.46 | 14.94 | 15.52 | 18.33 | 21.56 | 14.27 |
| 2800 | 16.04 | 14.25 | 14.68 | 15.31 | 18.34 | 22.20 | 14.12 |
| 2900 | 15.93 | 14.09 | 14.45 | 15.13 | 18.37 | 22.84 | 13.88 |
| 3000 | 15.75 | 13.95 | 14.25 | 14.98 | 18.40 | 23.41 | 13.68 |
| 3200 | 15.54 | 14.00 | 14.16 | 14.87 | 18.47 | 23.82 | 13.32 |
| 3400 | 15.77 | 14.34 | 14.25 | 14.93 | 18.58 | 23.13 | 13.13 |
| 3600 | 17.01 | 15.03 | 14.64 | 15.23 | 18.70 | 21.38 | 12.98 |
| 3800 | 19.28 | 16.28 | 15.29 | 15.64 | 18.30 | 18.93 | 13.00 |
| 4000 | 21.40 | 16.96 | 15.36 | 15.50 | 17.18 | 16.62 | 13.26 |
| 4200 | 21.67 | 17.69 | 15.53 | 15.42 | 16.20 | 14.93 | 14.18 |
| 4400 | 22.56 | 19.84 | 16.44 | 15.90 | 15.59 | 13.77 | 15.98 |
| 4600 | 25.28 | 23.81 | 17.81 | 16.62 | 15.00 | 12.82 | 18.41 |
| 4800 | 25.62 | 24.89 | 18.42 | 16.81 | 14.20 | 11.91 | 19.82 |
| 5000 | 21.48 | 21.71 | 18.06 | 16.62 | 13.56 | 11.28 | 18.47 |

Notes

- A. Performance and quality attributes and conditions not expressly stated in this specification document are intended to be excluded and do not form a part of this specification document.
- B. Electrical specifications and performance data contained in this specification document are based on Mini-Circuit's applicable established test performance criteria and measurement instructions.
- C. The parts covered by this specification document are subject to Mini-Circuit's standard limited warranty and terms and conditions (collectively, "Standard Terms"). Purchasers of this part are entitled to the rights and benefits contained therein. For a full statement of the Standard Terms and the exclusive rights and remedies thereunder, please visit Mini-Circuit's website at www.minicircuits.com/MC_Store/terms.jsp



Digital Step Attenuator

Typical Performance Curves

ZX76-31A-PN+

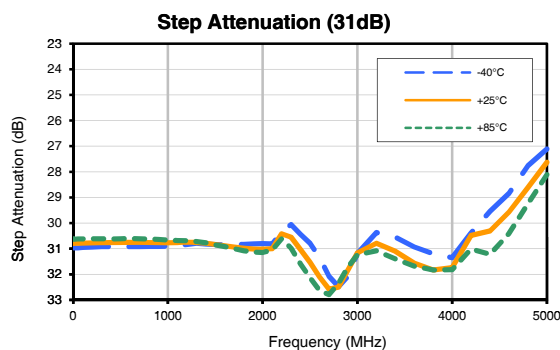
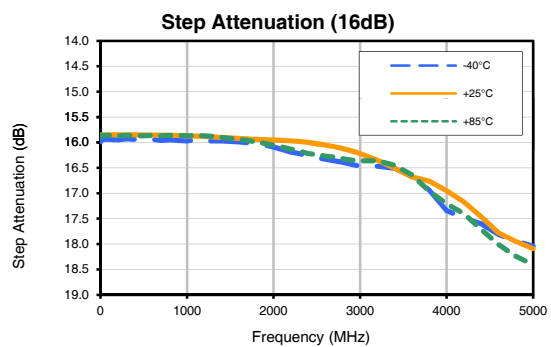
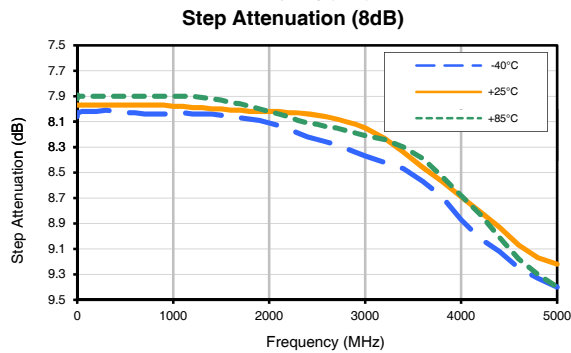
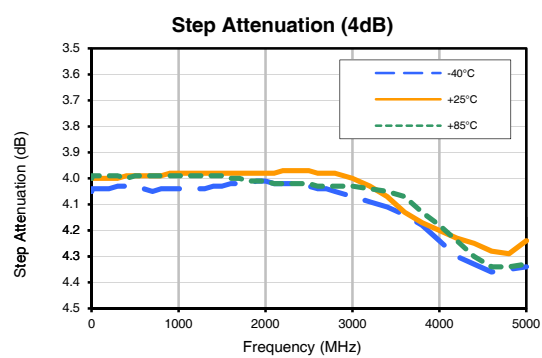
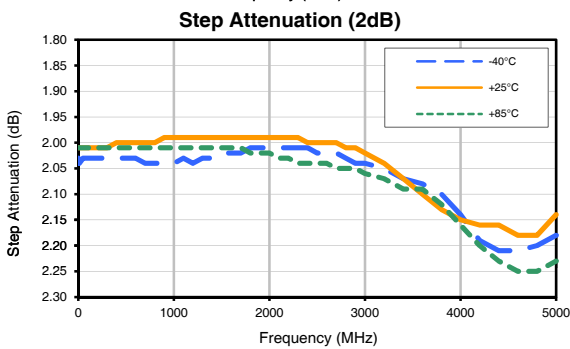
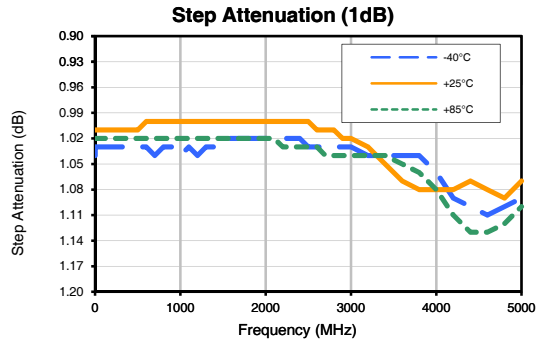
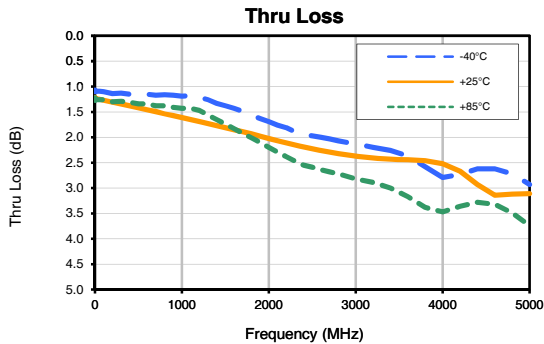

Notes

- A. Performance and quality attributes and conditions not expressly stated in this specification document are intended to be excluded and do not form a part of this specification document.
- B. Electrical specifications and performance data contained in this specification document are based on Mini-Circuits' applicable established test performance criteria and measurement instructions.
- C. The parts covered by this specification document are subject to Mini-Circuits' standard limited warranty and terms and conditions (collectively, "Standard Terms"); Purchasers of this part are entitled to the rights and benefits contained therein. For a full statement of the Standard Terms and the exclusive rights and remedies thereunder, please visit Mini-Circuits' website at www.minicircuits.com/MCLStore/terms.jsp



Digital Step Attenuator

Typical Performance Curves

ZX76-31A-PN+

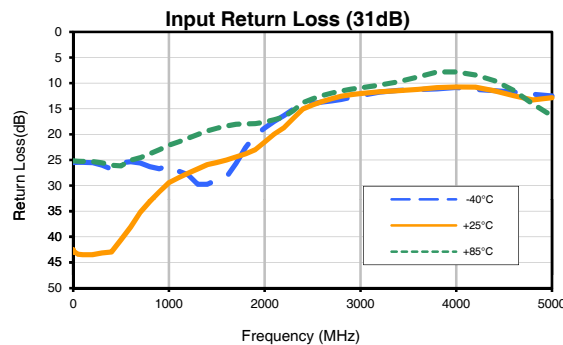
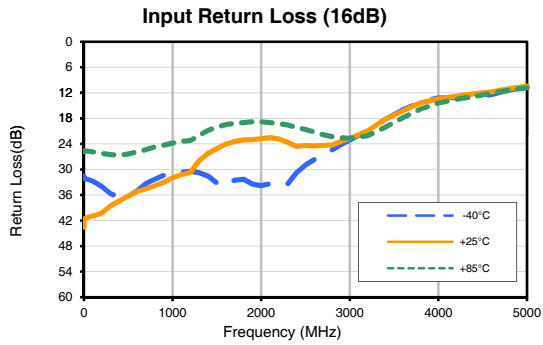
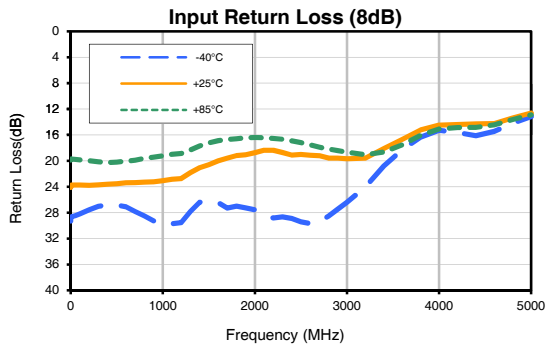
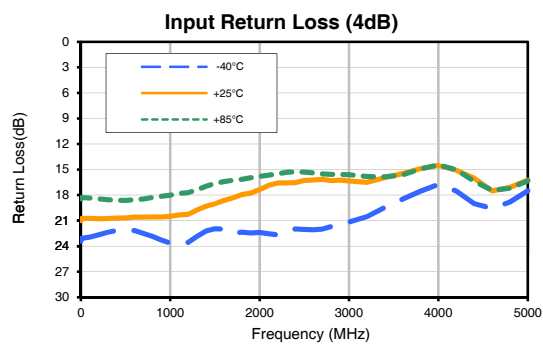
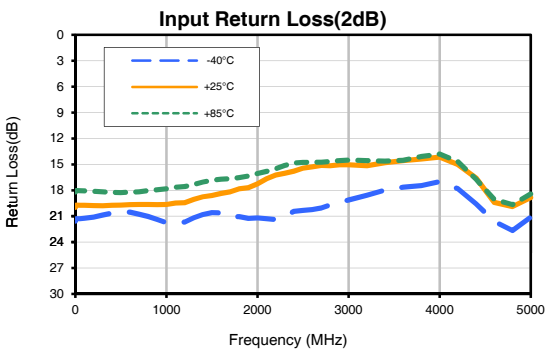
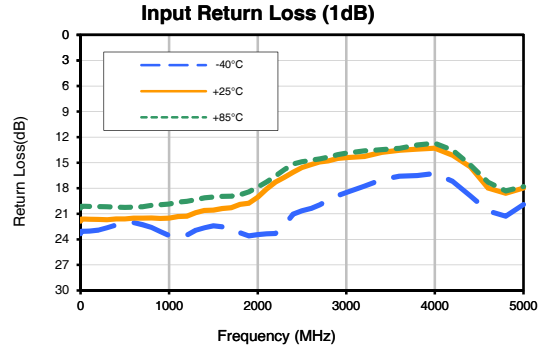
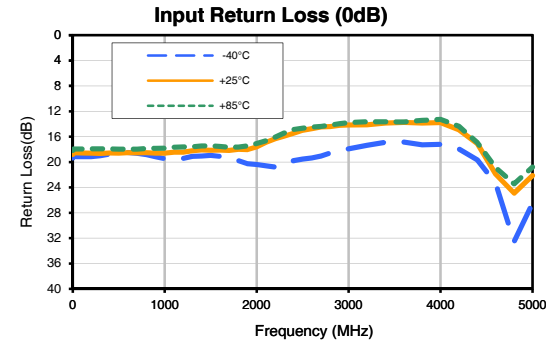

Notes

- A. Performance and quality attributes and conditions not expressly stated in this specification document are intended to be excluded and do not form a part of this specification document.
- B. Electrical specifications and performance data contained in this specification document are based on Mini-Circuits' applicable established test performance criteria and measurement instructions.
- C. The parts covered by this specification document are subject to Mini-Circuits' standard limited warranty and terms and conditions (collectively, "Standard Terms"). Purchasers of this part are entitled to the rights and benefits contained therein. For a full statement of the Standard Terms and the exclusive rights and remedies thereunder, please visit Mini-Circuits' website at www.minicircuits.com/MCLStore/terms.jsp



Typical Performance Curves

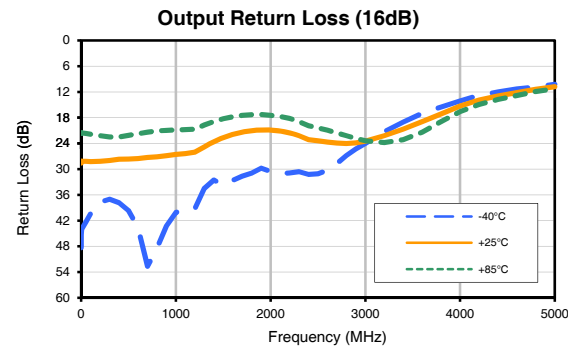
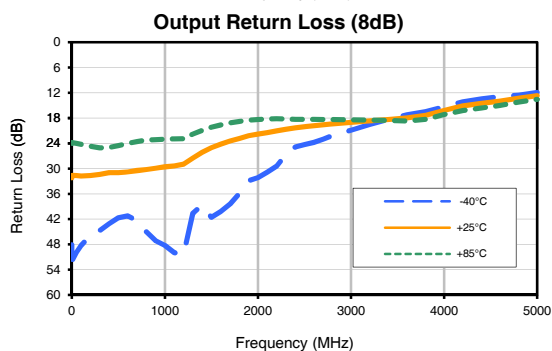
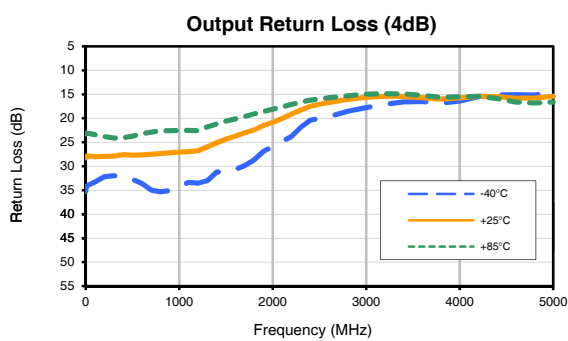
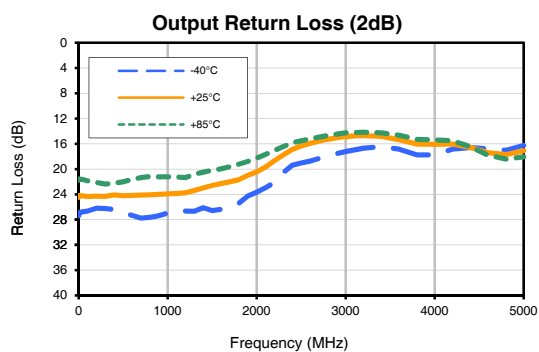
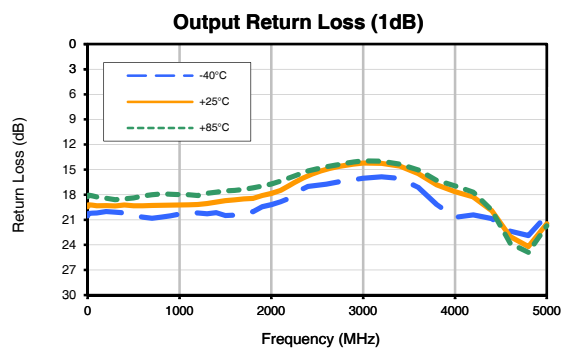
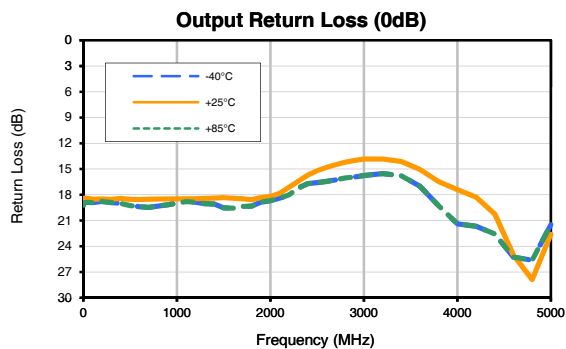

Notes

- A. Performance and quality attributes and conditions not expressly stated in this specification document are intended to be excluded and do not form a part of this specification document.
- B. Electrical specifications and performance data contained in this specification document are based on Mini-Circuits' applicable established test performance criteria and measurement instructions.
- C. The parts covered by this specification document are subject to Mini-Circuits' standard limited warranty and terms and conditions (collectively, "Standard Terms"). Purchasers of this part are entitled to the rights and benefits contained therein. For a full statement of the Standard Terms and the exclusive rights and remedies thereunder, please visit Mini-Circuits' website at www.minicircuits.com/MCLStore/terms.jsp



Case Style

HK

Outline Dimensions

HK1149

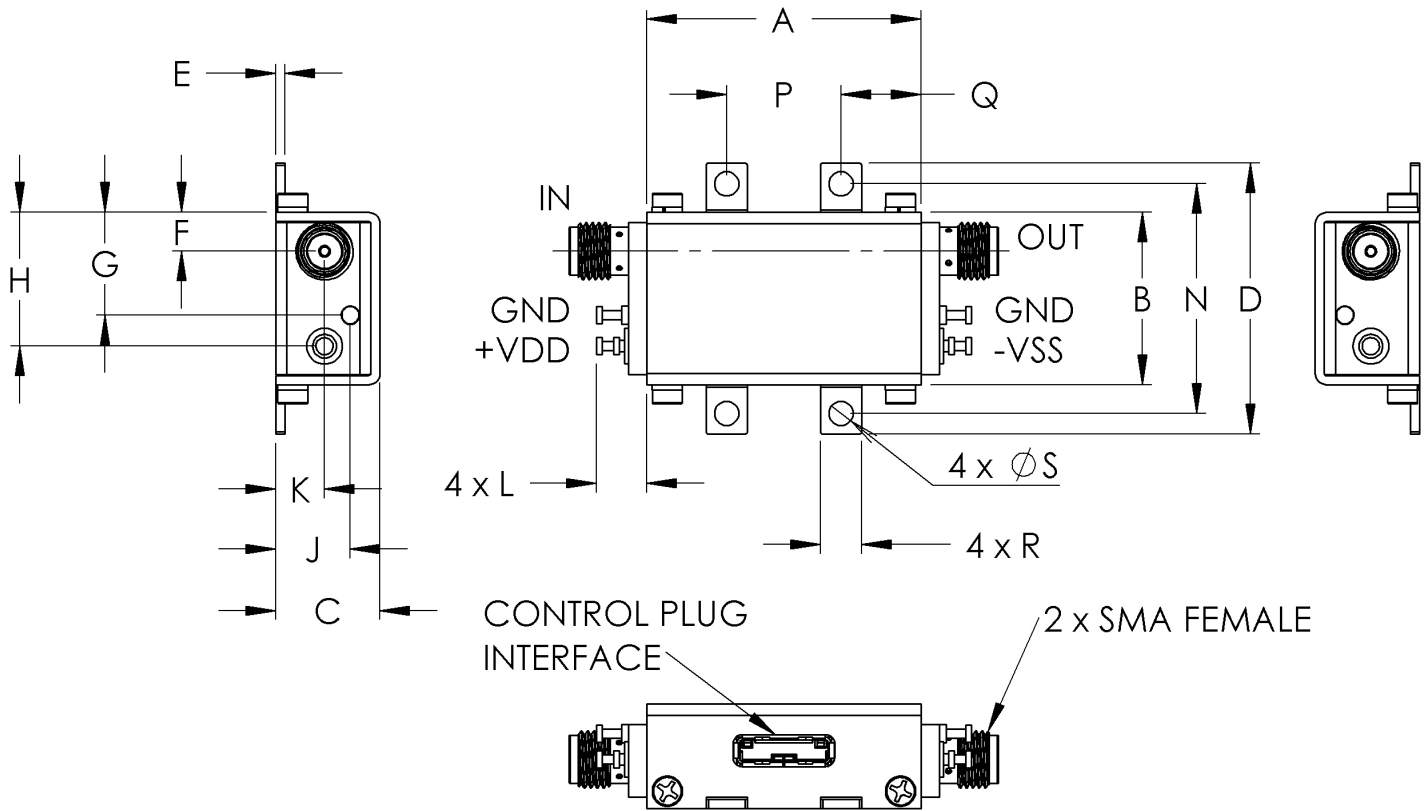

| CASE #. | A | B | C | D | E | F | G | H | J | K | L | M | N |
|---------|-----------------|----------------|----------------|-----------------|---------------|---------------|----------------|----------------|---------------|---------------|---------------|---|----------------|
| HK1149 | 1.20 (30.48) | .75 (19.15) | .46 (11.61) | 1.18 (30.07) | .04 (1.02) | .17 (4.32) | .45 (11.40) | .59 (14.86) | .33 (8.31) | .21 (5.44) | .22 (5.59) | - | 1.00 (25.4) |

| CASE #. | P | Q | R | S | WT GRAMS |
|---------|----------------|---------------|---------------|----------------|----------|
| HK1149 | .50 (12.70) | .35 (8.89) | .18 (4.57) | .106 (2.69) | 35 |

Dimensions are in inches (mm). Tolerances: 2Pl. $\pm .03$; 3Pl. $\pm .015$
Tolerance on hole size and interaxes dimensions to be $\pm .005$.

Note:

1. Case material: Brass
2. Case finish: Nickel plate

Mini-Circuits®

INTERNET <http://www.minicircuits.com>

P.O. Box 350166, Brooklyn, New York 11235-0003 (718) 934-4500 Fax (718) 332-4661

Distribution Centers NORTH AMERICA 800-654-7949 • 417-335-5935 • Fax 417-335-5945 • EUROPE 44-1252-832600 • Fax 44-1252-837010

Mini-Circuits ISO 9001 & ISO 14001 Certified

All Mini-Circuits products are manufactured under exacting quality assurance and control standards, and are capable of meeting published specifications after being subjected to any or all of the following physical and environmental test.

| Specification | Test/Inspection Condition | Reference/Spec |
|----------------------------|--|--------------------------------------|
| Operating Temperature | -40° to 85° C Ambient Environment | Individual Model Data Sheet |
| Storage Temperature | -40° to 85° C Ambient Environment | Individual Model Data Sheet |
| Barometric Pressure | 100,000 Feet | MIL-STD-202, Method 105, Condition D |
| Humidity | 90% RH, 65°C Units may require bake-out after humidity to restore full performance. | MIL-STD-202, Method 103 |
| Thermal Shock | -65° to 125°C, 5 cycles | MIL-STD-202, Method 107, Condition B |
| Vibration (High Frequency) | 20g peak, 10-2000 Hz, 12 times in each of three perpendicular directions (total 36) | MIL-STD-202, Method 204, Condition D |
| Mechanical Shock | 100g, 6ms sawtooth, 3 shocks each direction 3 axes (total 18) | MIL-STD-202, Method 213, Condition I |