



## COAXIAL WIDEBAND

# Digital Step Attenuator **ZX76-15R5A-PNS+**

50Ω 15.5 dB, 0.5 dB Step DC to 4 GHz

### THE BIG DEAL

- 5-bit digital step attenuator
- High speed parallel control interface
- Low insertion loss
- Fast attenuation transitions
- No control software or PC required



Generic photo used for illustration purposes only

Model No.	ZX76-15R5A-PNS+
Case Style	HK1149
Connectors	SMA

### APPLICATIONS

- Test Setup
- Lab
- Instrumentation

### RoHS Compliant

See our website for RoHS Compliance methodologies and qualifications

### PRODUCT OVERVIEW

ZX76-15R5A-PNS+ is a 5-bit digital step attenuator with parallel control and dual (positive and negative) supply voltage inputs. Attenuation can be set from 0 to 15.5 dB in 0.5 dB steps, with 0.1 dB typical accuracy. The attenuator is housed in a compact unibody package, with SMA RF connections and a snap-fit control input.

The high speed parallel control interface supports manual control and integration with a wide range of microcontroller and custom I/O (input / output) control systems. Data is entered into the internal 5-bit register using 5V logic levels and then latched to set the attenuation.

For applications requiring Ethernet / USB control and software support, please review Mini-Circuits' R\_DAT series of programmable attenuators at <https://www.minicircuits.com/WebStore/RF-Programmable-Step-Attenuators.html>

### KEY FEATURES

Feature	Advantages
Wideband operation, from DC to 4 GHz	Supports a range of applications in communications, satellite and defense.
Excellent RF performance	Low insertion loss and 18 dB typical return loss minimize the impact on overall system performance.
Dual voltage supply inputs	Separate positive & negative supply rails reduce the noise & spurious effects associated with internal negative voltage generators and allow faster attenuation switching (up to 1 MHz).
Parallel control	High speed parallel control, no PC, software control or clock needed. Allows manual control of attenuation setting. Designed for integration with generic control systems at 5V logic levels.

**RF ELECTRICAL SPECIFICATIONS, DC - 4 GHz,  $T_{AMB}=25^{\circ}C$ ,  $V_{DD}=+3V$ ,  $V_{SS}=-3.3V$** 

Parameter	Frequency (MHz)	Min.	Typ.	Max.	Units
Insertion Loss @ 0dB Attenuation Setting	DC - 1000	—	1.4	2.0	dB
	1000 - 2400	—	1.9	2.7	
	2400 - 4000	—	2.5	3.3	
Accuracy @ 0.5 dB Attenuation Setting	DC - 1000	—	$\pm 0.03$	$\pm 0.10$	dB
	1000 - 2400	—	$\pm 0.05$	$\pm 0.15$	
	2400 - 4000	—	$\pm 0.07$	$\pm 0.20$	
Accuracy @ 1 dB Attenuation Setting	DC - 1000	—	$\pm 0.02$	$\pm 0.10$	dB
	1000 - 2400	—	$\pm 0.05$	$\pm 0.15$	
	2400 - 4000	—	$\pm 0.10$	$\pm 0.25$	
Accuracy @ 2 dB Attenuation Setting	DC - 1000	—	$\pm 0.05$	$\pm 0.15$	dB
	1000 - 2400	—	$\pm 0.15$	$\pm 0.25$	
	2400 - 4000	—	$\pm 0.15$	$\pm 0.35$	
Accuracy @ 4 dB Attenuation Setting	DC - 1000	—	$\pm 0.07$	$\pm 0.20$	dB
	1000 - 2400	—	$\pm 0.15$	$\pm 0.25$	
	2400 - 4000	—	$\pm 0.23$	$\pm 0.50$	
Accuracy @ 8 dB Attenuation Setting	DC - 1000	—	$\pm 0.03$	$\pm 0.25$	dB
	1000 - 2400	—	$\pm 0.15$	$\pm 0.50$	
	2400 - 4000	—	$\pm 0.60$	$\pm 0.80$	
Input IP3 (at Min. and Max. Attenuation) <sup>1</sup>	DC - 4000	—	+52	—	dBm
Input Power @ 0.2dB Compression (at Min. and Max. Attenuation) <sup>1</sup>	DC - 4000	—	+24	—	
Input Operating Power	0.010 - 50	—	—	See figure 1	dBm
	50 - 4000	—	—	+24	
Return Loss	DC - 1000	12.5	21	—	dB
	1000 - 2400	11.5	18	—	
	2400 - 4000	10.0	15	—	

1. Input IP3 and 1dB compression degrade below 1 MHz. Input power not to exceed max operating specification for continuous operation.

**DC ELECTRICAL SPECIFICATIONS**

Parameter	Min.	Typ.	Max.	Units
Positive Supply Voltage, $V_{DD}$	+2.7	+3	+3.6	V
Positive Supply Current, $I_{DD}$	—	—	3	mA
Negative Supply Voltage, $V_{SS}$	-3.6	-3.3	-3.2	V
Negative Supply Current, $I_{SS}$	—	16	40	$\mu A$
Control Input Low	-0.3	—	+0.3x $V_{DD}$	V
Control Input High	+0.7x $V_{DD}$	—	+5	V
Control Current	—	—	400	$\mu A$

**SWITCHING SPECIFICATIONS**

Parameter	Min.	Typ.	Max.	Units
Switching Speed, 50% Control to 0.5dB of Attenuation Value	—	1	—	$\mu sec$
Switching Control Frequency	—	1	—	MHz

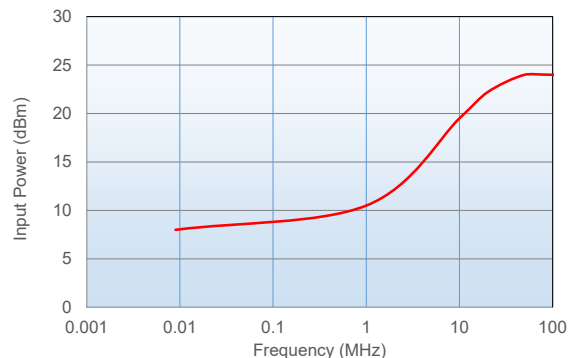
**FIGURE 1: Max Input Operating Power vs Frequency**



### ABSOLUTE MAXIMUM RATINGS

Parameter	Ratings
Operating Temperature	-40°C to 85°C
Storage Temperature	-40°C to 85°C
V <sub>DD</sub>	-0.3V Min., +5.5V Max.
V <sub>SS</sub>	-3.6V Min., +0.3V Max.
Voltage on any control input	-0.3V Min., +6V Max.
ESD, HBM	500V
ESD, MM	100V
Input Power	+30dBm

Permanent damage may occur if any of these limits are exceeded. Operating in the range between operating power limits and absolute maximum ratings for extended periods of time may result in reduced life and reliability.

### PIN CONFIGURATION

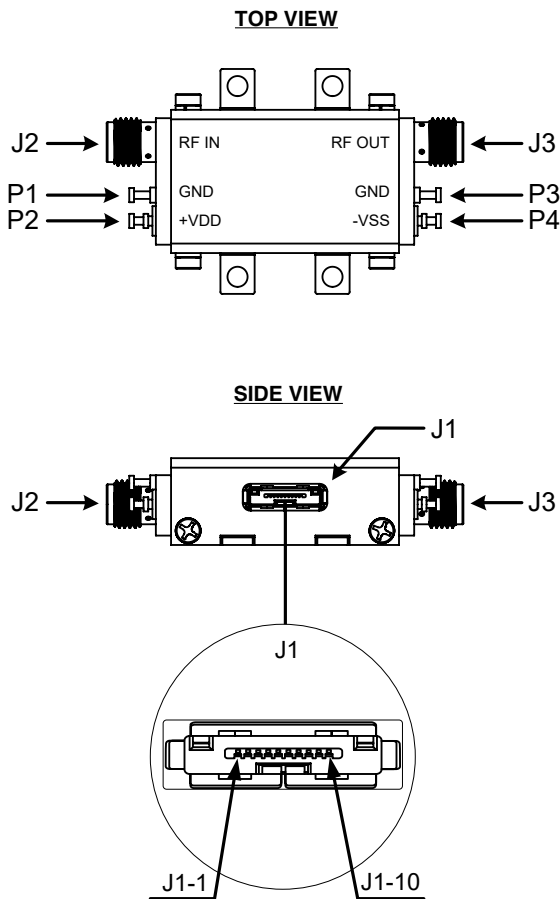

### PIN DESCRIPTION

Function	Pin Number	Description
LE	J1-1	Latch Enable Input
C1	J1-2	Control for attenuation bit, 1.0 dB
C0.5	J1-3	Control for attenuation bit, 0.5 dB
N/C	J1-4	Not Connected
N/C	J1-5	Not Connected
GND	J1-6	Ground Connection
GND	J1-7	Ground Connection
C4	J1-8	Control for attenuation bit, 4 dB
C8	J1-9	Control for attenuation bit, 8 dB
C2	J1-10	Control for attenuation bit, 2 dB
RF in	J2	RF in port <sup>2</sup>
RF out	J3	RF out port <sup>2</sup>
GND	P1	Ground Connection
V <sub>DD</sub>	P2	Positive Supply Voltage
GND	P3	Ground Connection
V <sub>SS</sub>	P4	Negative Supply Voltage

<sup>2</sup> Both RF ports must be held at 0VDC or DC blocked with an external series capacitor.



### SIMPLIFIED SCHEMATIC

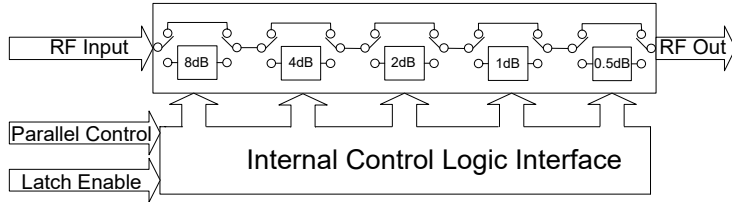

The ZX76-15R5A-PNS+ parallel interface consists of 6 control bits that select the desired attenuation state, as shown in Table 1: Truth Table.

TABLE 1. TRUTH TABLE

Attenuation State	C8	C4	C2	C1	C0.5
Reference	0	0	0	0	0
0.5 (dB)	0	0	0	0	1
1 (dB)	0	0	0	1	0
2 (dB)	0	0	1	0	0
4 (dB)	0	1	0	0	0
8 (dB)	1	0	0	0	0
15.5 (dB)	1	1	1	1	1

Note: Not all 32 possible combinations of C0.5 - C8 are shown in table

The parallel interface timing requirements are defined by Figure 2 (Parallel Interface Timing Diagram) and Table 2 (Parallel Interface AC Characteristics), and the switching speed.

For latched parallel programming the Latch Enable (LE) should be held LOW while changing attenuation state control values, then pulse LE HIGH to LOW (per Figure 1) to latch new attenuation state into the device.

For direct parallel programming, the Latch Enable (LE) line should be pulled HIGH. Changing the attenuation state control values will immediately change the device's state to a new attenuation value. Direct mode is ideal for manual control of the device (using hardwire, switches, or jumpers).

Control cables for programming can be ordered separately. For details see page 5.

TABLE 2. PARALLEL INTERFACE AC CHARACTERISTICS

Symbol	Parameter	Min.	Units
$t_{LEPW}$	LE minimum pulse width	10	ns
$t_{PDSUP}$	Data set-up time before clock rising edge of LE	10	ns
$t_{PDHLD}$	Data hold time after clock falling edge of LE	10	ns

FIGURE 2: PARALLEL INTERFACE TIMING DIAGRAM

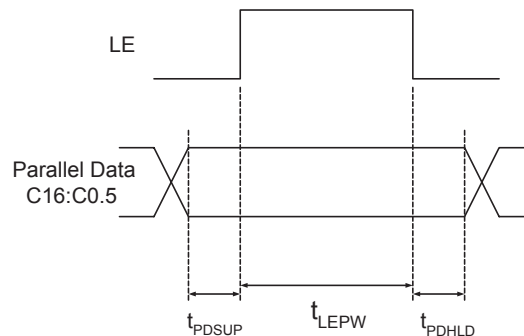

### POWER-UP STATE

When the attenuator powers up and LE is logic low, the nominal attenuation is set on 0 dB. When LE is logic high, the nominal attenuation selected upon control logics ( see Table 1 ).



## ZX76-WP+ CONTROL CABLE

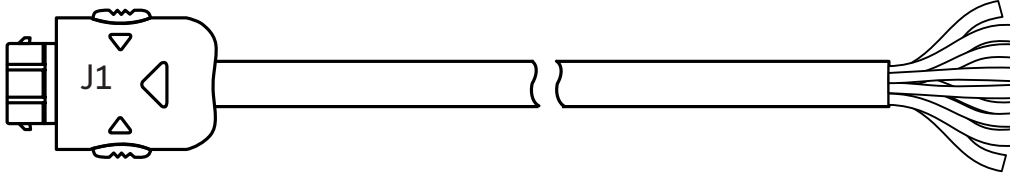

## RECOMMENDED ACCESSORIES

An optional ZX76-WP+ is a shielded cable on one end and a connector on the other end designed to mate to the ZX76-15R5A-PNS+. These bare wires enable the customer to assemble their own cable as required to interface with the ZX76-15R5A-PNS+ (cable length is 4.9ft/ 1.5meters).

## ZX76-WP+ WIRING INFORMATION

J1 Pin Number	Function	Description	Wire Color
J1-1	LE	Latch Enable Input	White
J1-2	C1	Control for attenuation bit, 1.0 dB	Yellow
J1-3	C0.5	Control for attenuation bit, 0.5 dB	Green
J1-7	GND	Ground Connection	Black
J1-8	C4	Control for attenuation bit, 4.0 dB	Orange
J1-9	C8	Control for attenuation bit, 8.0 dB	Brown
J1-10	C2	Control for attenuation bit, 2.0 dB	Red

Note: Other pins not connected. Cable shield connected to case ground.



TYPICAL PERFORMANCE DATA (AT 25°C)

Freq. [MHz]	I.Loss [dB]	Attenuation relative to Insertion Loss [dB]					
		@ Attenuation setting [dB]					
		0.5	1	2	4	8	15.5
0.1	-1.21	0.46	-0.01	-0.01	0.00	0.03	0.04
1	-1.23	0.47	-0.01	-0.01	0.00	0.03	0.04
10	-1.24	0.47	-0.01	-0.01	0.00	0.03	0.03
100	-1.27	0.47	-0.01	-0.01	0.00	0.03	0.04
200	-1.31	0.47	-0.01	-0.01	0.00	0.03	0.05
400	-1.38	0.47	-0.01	0.00	0.01	0.03	0.05
500	-1.42	0.47	-0.01	0.00	0.01	0.03	0.06
700	-1.49	0.47	0.00	0.00	0.01	0.03	0.06
800	-1.54	0.47	0.00	0.00	0.01	0.03	0.06
1000	-1.61	0.47	0.00	0.01	0.02	0.02	0.05
1100	-1.65	0.47	0.00	0.01	0.02	0.02	0.04
1300	-1.73	0.47	0.00	0.01	0.02	0.01	0.03
1450	-1.79	0.47	0.00	0.01	0.01	0.00	-0.01
1750	-1.92	0.47	0.00	0.01	0.02	-0.01	-0.11
1900	-1.98	0.48	0.00	0.01	0.02	-0.02	-0.19
2200	-2.11	0.47	0.00	0.01	0.03	-0.03	-0.32
2350	-2.18	0.47	0.00	0.01	0.03	-0.03	-0.40
2650	-2.29	0.46	-0.01	0.00	0.03	-0.06	-0.76
2800	-2.32	0.46	-0.01	-0.01	0.02	-0.10	-1.00
3100	-2.39	0.46	-0.03	-0.03	-0.01	-0.19	-1.13
3250	-2.41	0.46	-0.04	-0.05	-0.04	-0.26	-1.17
3550	-2.44	0.46	-0.06	-0.10	-0.11	-0.43	-1.28
3700	-2.45	0.46	-0.07	-0.12	-0.15	-0.52	-1.32
3900	-2.48	0.46	-0.08	-0.14	-0.19	-0.63	-1.37
4000	-2.52	0.45	-0.08	-0.15	-0.20	-0.69	-1.41

Freq. [MHz]	Return Loss In [dB]							Return Loss Out [dB]						
	@ Attenuation setting [dB]							@ Attenuation setting [dB]						
	0	0.5	1	2	4	8	15.5	0	0.5	1	2	4	8	15.5
0.1	-18.79	-20.34	-21.87	-19.97	-21.00	-24.11	-28.22	-18.63	-19.24	-19.43	-24.48	-28.24	-32.18	-52.48
1	-18.66	-20.23	-21.75	-19.81	-20.79	-23.77	-28.28	-18.51	-19.13	-19.30	-24.34	-27.99	-31.68	-52.93
10	-18.54	-20.10	-21.62	-19.72	-20.73	-23.73	-28.44	-18.39	-19.02	-19.21	-24.20	-27.86	-31.61	-54.08
100	-18.57	-20.12	-21.63	-19.74	-20.74	-23.72	-28.45	-18.52	-19.15	-19.33	-24.35	-28.02	-31.76	-53.68
200	-18.59	-20.15	-21.66	-19.77	-20.78	-23.77	-28.48	-18.49	-19.12	-19.30	-24.30	-27.94	-31.64	-53.34
400	-18.58	-20.12	-21.61	-19.73	-20.70	-23.60	-28.44	-18.42	-19.03	-19.22	-24.10	-27.58	-30.96	-50.27
500	-18.59	-20.12	-21.60	-19.72	-20.68	-23.53	-28.34	-18.53	-19.14	-19.32	-24.22	-27.69	-30.98	-63.15
700	-18.54	-20.05	-21.51	-19.64	-20.58	-23.35	-27.90	-18.51	-19.11	-19.28	-24.10	-27.46	-30.44	-50.38
800	-18.53	-20.03	-21.49	-19.63	-20.56	-23.28	-27.46	-18.50	-19.10	-19.27	-24.06	-27.37	-30.24	-44.39
1000	-18.60	-20.08	-21.51	-19.63	-20.49	-23.06	-25.71	-18.49	-19.07	-19.23	-23.92	-27.04	-29.56	-35.53
1100	-18.45	-19.92	-21.32	-19.48	-20.32	-22.83	-25.00	-18.47	-19.06	-19.21	-23.87	-26.96	-29.35	-32.36
1300	-18.21	-19.58	-20.87	-19.05	-19.74	-21.82	-23.14	-18.43	-18.96	-19.05	-23.40	-25.97	-27.52	-27.38
1450	-18.16	-19.44	-20.63	-18.72	-19.19	-20.87	-21.89	-18.39	-18.82	-18.82	-22.80	-24.76	-25.59	-24.62
1750	-18.02	-19.10	-20.04	-17.94	-18.07	-19.27	-19.99	-18.59	-18.74	-18.53	-21.92	-22.78	-23.15	-20.30
1900	-18.03	-18.96	-19.75	-17.70	-17.77	-19.05	-19.36	-18.33	-18.34	-18.09	-21.00	-21.52	-22.19	-18.57
2200	-16.33	-16.85	-17.27	-16.23	-16.59	-18.37	-17.35	-17.11	-16.99	-16.87	-18.66	-19.11	-21.03	-16.04
2350	-15.74	-16.13	-16.45	-15.95	-16.61	-18.97	-15.59	-16.08	-16.01	-16.02	-17.33	-17.92	-20.53	-15.23
2650	-14.58	-14.86	-15.07	-15.20	-16.20	-19.23	-13.43	-14.64	-14.69	-14.85	-15.74	-16.50	-19.69	-14.54
2800	-14.41	-14.63	-14.78	-15.16	-16.30	-19.58	-12.82	-14.20	-14.29	-14.49	-15.28	-16.08	-19.41	-14.17
3100	-14.14	-14.30	-14.36	-15.11	-16.45	-19.79	-12.53	-13.82	-13.96	-14.21	-14.75	-15.51	-18.80	-13.23
3250	-14.11	-14.22	-14.22	-15.13	-16.46	-19.38	-12.66	-13.91	-14.08	-14.34	-14.75	-15.46	-18.62	-12.90
3550	-14.01	-13.95	-13.79	-14.86	-15.83	-17.18	-12.52	-14.85	-15.02	-15.28	-15.26	-15.68	-18.10	-12.58
3700	-13.95	-13.81	-13.59	-14.62	-15.33	-15.99	-12.47	-15.81	-15.95	-16.20	-15.76	-15.94	-17.75	-12.43
3900	-13.72	-13.53	-13.24	-14.13	-14.52	-14.60	-12.24	-17.04	-17.14	-17.36	-16.18	-15.99	-16.83	-12.33
4000	-13.77	-13.60	-13.30	-14.15	-14.51	-14.49	-12.26	-17.39	-17.45	-17.64	-16.09	-15.76	-16.18	-12.34



### TYPICAL PERFORMANCE CURVES (AT 25°C)

Attenuation Accuracy relative to Insertion Loss vs. Frequency

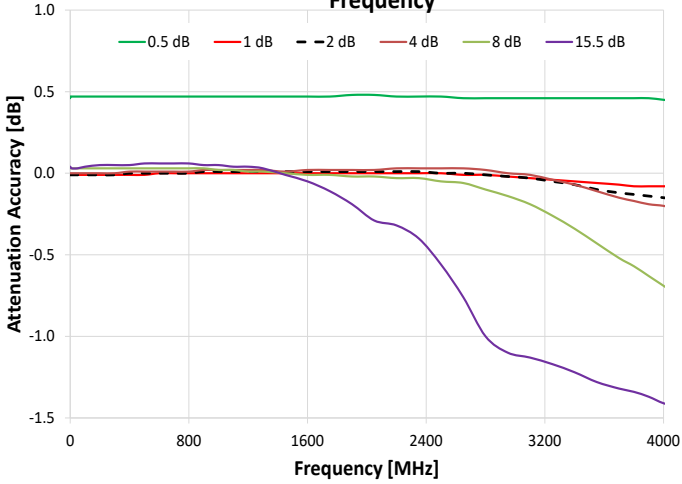

Attenuation relative to Insertion Loss vs. Frequency

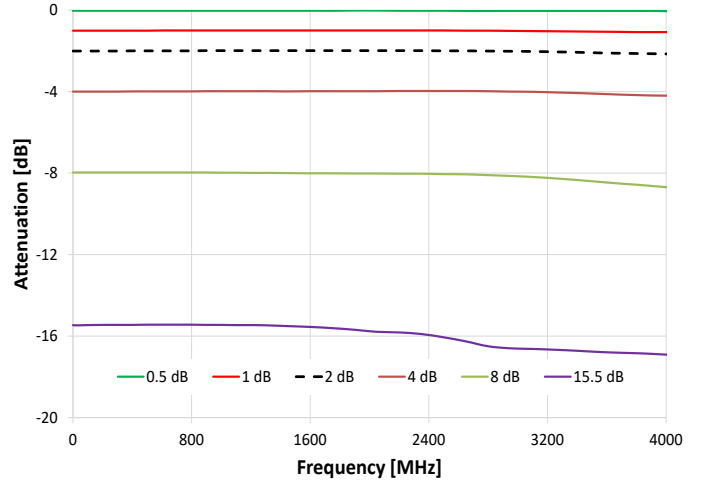

Insertion Loss vs. Frequency

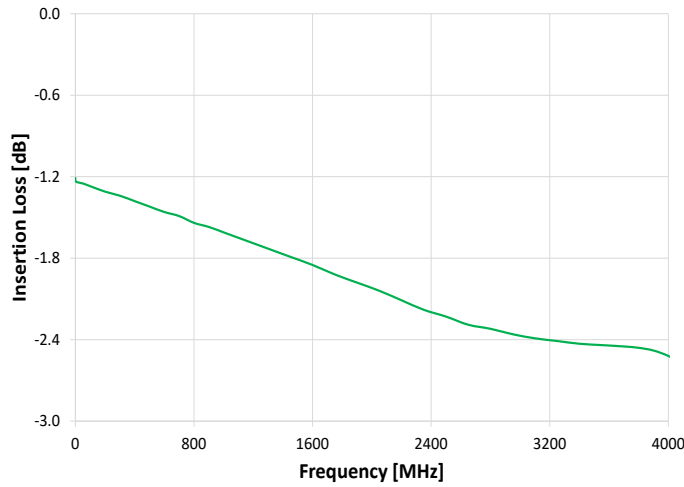

R. Loss In vs. Frequency over Attenuation settings

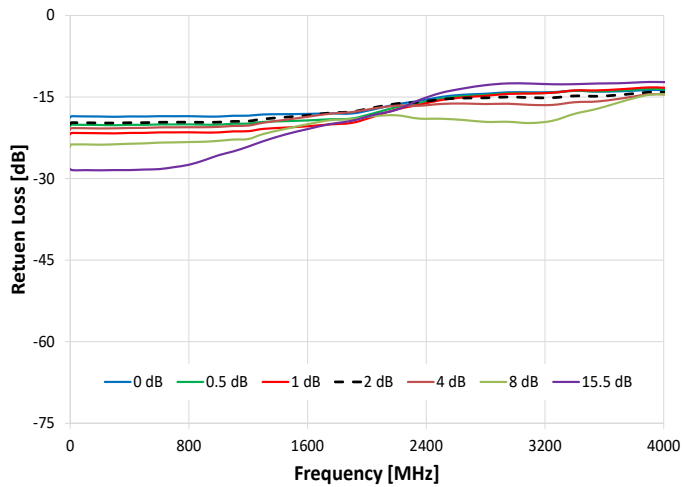

R. Loss Out vs. Frequency over Attenuation settings

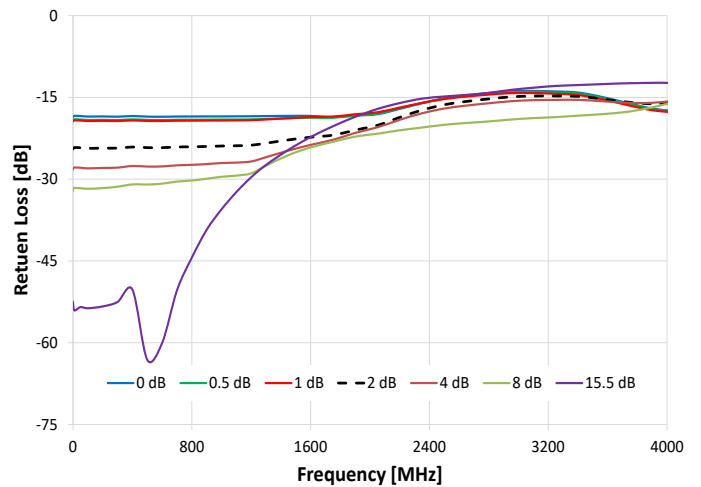



### ORDERING INFORMATION

Model	Description
ZX76-15R5A-PNS+	Digital attenuator - Parallel interface, Dual Voltage (Positive & Negative)

Recommended Accessories	Part No.	Description
	ZX76-WP+	4.9 ft. (1.5M) Control Cable

### ADDITIONAL DETAILED TECHNICAL INFORMATION

Performance Data	Data Table
	Swept Graphs
	S-Parameter (S2P Files) Data Set (.zip.file)
Case Style	HK1149
Environmental Rating	ENV28T14

Additional information is available on our dash board. To access this information [click here](#)

#### NOTES

- A. Performance and quality attributes and conditions not expressly stated in this specification document are intended to be excluded and do not form a part of this specification document.
- B. Electrical specifications and performance data contained in this specification document are based on Mini-Circuit's applicable established test performance criteria and measurement instructions.
- C. The parts covered by this specification document are subject to Mini-Circuits standard limited warranty and terms and conditions (collectively, "Standard Terms"); Purchasers of this part are entitled to the rights and benefits contained therein. For a full statement of the standard. Terms and the exclusive rights and remedies thereunder, please visit Mini-Circuits' website at [www.minicircuits.com/MCLStore/terms.jsp](http://www.minicircuits.com/MCLStore/terms.jsp)



# Digital Step Attenuator

# ZX76-15R5A-PN+

## Typical Performance Data

TEST CONDITIONS: INPUT POWER=0 dBm, Vdd=+3V, TEMPERATURE=-40°C

FREQUENCY (MHz)	STEP ATTENUATION* AT TTL CONTROL STATE						
	(dB)						
	000000 THRU LOSS	000001 0.5 dB	000010 1.0 dB	000100 2.0 dB	001000 4.0 dB	010000 8.0 dB	011111 15.5 dB
0.1	1.07	0.54	1.04	2.04	4.05	8.06	15.62
0.3	1.07	0.54	1.04	2.04	4.05	8.05	15.62
0.5	1.09	0.53	1.04	2.04	4.04	8.04	15.63
1	1.10	0.53	1.03	2.03	4.04	8.03	15.63
5	1.09	0.53	1.03	2.04	4.04	8.03	15.64
10	1.09	0.53	1.03	2.04	4.04	8.03	15.64
50	1.09	0.53	1.03	2.03	4.04	8.02	15.64
100	1.10	0.53	1.03	2.03	4.04	8.02	15.63
200	1.14	0.53	1.03	2.03	4.04	8.02	15.61
300	1.13	0.53	1.03	2.03	4.03	8.01	15.60
400	1.15	0.53	1.03	2.03	4.03	8.02	15.60
500	1.16	0.53	1.03	2.03	4.04	8.03	15.60
600	1.15	0.53	1.03	2.03	4.04	8.03	15.62
700	1.17	0.53	1.04	2.04	4.05	8.04	15.62
800	1.16	0.53	1.03	2.04	4.04	8.04	15.62
900	1.17	0.53	1.03	2.04	4.04	8.04	15.63
1000	1.19	0.53	1.04	2.04	4.04	8.04	15.64
1100	1.18	0.53	1.03	2.03	4.04	8.03	15.64
1200	1.21	0.53	1.04	2.04	4.04	8.04	15.65
1300	1.26	0.53	1.03	2.03	4.04	8.04	15.64
1400	1.33	0.53	1.03	2.03	4.03	8.04	15.66
1500	1.38	0.53	1.02	2.02	4.03	8.05	15.68
1600	1.43	0.53	1.02	2.02	4.02	8.05	15.71
1700	1.49	0.53	1.02	2.02	4.02	8.07	15.73
1800	1.56	0.52	1.02	2.01	4.02	8.08	15.77
1900	1.63	0.52	1.02	2.01	4.01	8.09	15.83
2000	1.69	0.52	1.02	2.01	4.01	8.11	15.89
2100	1.76	0.52	1.02	2.01	4.02	8.13	15.97
2200	1.81	0.53	1.02	2.01	4.02	8.16	16.03
2300	1.89	0.53	1.02	2.01	4.02	8.19	15.99
2400	1.95	0.53	1.02	2.01	4.03	8.22	16.09
2500	1.97	0.53	1.03	2.02	4.03	8.24	16.16
2600	2.00	0.54	1.03	2.02	4.04	8.26	16.26
2700	2.03	0.54	1.03	2.02	4.04	8.28	16.42
2800	2.07	0.54	1.03	2.03	4.05	8.31	16.61
2900	2.10	0.54	1.03	2.04	4.06	8.34	16.78
3000	2.13	0.54	1.03	2.04	4.07	8.37	16.85
3200	2.20	0.54	1.04	2.05	4.09	8.42	16.87
3400	2.26	0.54	1.04	2.07	4.11	8.47	16.93
3600	2.37	0.54	1.04	2.08	4.14	8.57	16.98
3800	2.58	0.54	1.04	2.10	4.18	8.69	17.02
4000	2.79	0.55	1.06	2.14	4.24	8.87	17.09
4200	2.73	0.57	1.09	2.19	4.30	9.02	17.19
4400	2.62	0.58	1.10	2.21	4.33	9.12	17.17
4600	2.62	0.58	1.11	2.21	4.36	9.25	17.51
4800	2.72	0.58	1.10	2.20	4.35	9.33	17.68
5000	2.93	0.58	1.09	2.18	4.34	9.40	18.06

\* Step Attenuation above Thru Loss (TTL Logic 00000).

**Notes**

- A. Performance and quality attributes and conditions not expressly stated in this specification document are intended to be excluded and do not form a part of this specification document.
- B. Electrical specifications and performance data contained in this specification document are based on Mini-Circuits' applicable established test performance criteria and measurement instructions.
- C. The parts covered by this specification document are subject to Mini-Circuits' standard limited warranty and terms and conditions (collectively, "Standard Terms"); Purchasers of this part are entitled to the rights and benefits contained therein. For a full statement of the Standard Terms and the exclusive rights and remedies thereunder, please visit Mini-Circuits' website at [www.minicircuits.com/MC\\_Store/terms.jsp](http://www.minicircuits.com/MC_Store/terms.jsp)



# Digital Step Attenuator

# ZX76-15R5A-PN+

## Typical Performance Data

TEST CONDITIONS: INPUT POWER=0 dBm, Vdd=+3V, TEMPERATURE=-40°C

FREQUENCY (MHz)	INPUT RETURN LOSS AT TTL CONTROL STATE						
	(dB)						
	000000 0 dB	000001 0.5 dB	000010 1.0 dB	000100 2.0 dB	001000 4.0 dB	010000 8.0 dB	011111 15.5 dB
0.1	19.34	21.29	23.32	21.57	23.41	29.28	40.77
0.3	19.32	21.28	23.30	21.55	23.38	29.22	40.66
0.5	19.32	21.28	23.30	21.49	23.28	28.96	40.61
1	19.24	21.21	23.22	21.40	23.18	28.81	40.58
5	19.13	21.08	23.07	21.31	23.09	28.67	39.86
10	19.12	21.07	23.05	21.29	23.07	28.63	39.85
50	19.14	21.08	23.05	21.28	23.02	28.47	40.01
100	19.16	21.08	23.02	21.24	22.93	28.19	40.18
200	19.14	21.01	22.91	21.10	22.67	27.57	40.30
300	18.99	20.81	22.64	20.86	22.37	27.02	41.91
400	18.74	20.52	22.31	20.64	22.16	26.81	45.91
500	18.60	20.37	22.13	20.54	22.11	26.83	39.28
600	18.50	20.27	22.03	20.52	22.17	27.09	37.89
700	18.63	20.45	22.28	20.76	22.51	27.82	39.23
800	18.82	20.71	22.60	21.03	22.85	28.51	43.58
900	19.14	21.09	23.08	21.39	23.28	29.27	44.51
1000	19.47	21.49	23.56	21.75	23.65	29.87	44.50
1100	19.47	21.49	23.56	21.74	23.62	29.70	49.23
1200	19.42	21.43	23.50	21.68	23.56	29.53	57.26
1300	19.10	21.00	22.93	21.17	22.85	27.81	43.74
1400	19.04	20.85	22.64	20.80	22.22	26.41	35.99
1500	18.96	20.70	22.41	20.58	21.96	26.24	32.24
1600	19.10	20.84	22.52	20.63	21.99	26.44	29.38
1700	19.63	21.45	23.19	21.10	22.51	27.30	26.68
1800	19.77	21.55	23.22	21.05	22.36	26.99	24.08
1900	20.27	21.98	23.59	21.25	22.45	27.27	21.87
2000	20.38	21.97	23.44	21.20	22.40	27.56	20.25
2100	20.58	22.06	23.35	21.28	22.54	28.24	18.88
2200	20.80	22.19	23.31	21.39	22.68	28.81	17.59
2300	20.54	21.59	22.35	21.01	22.32	28.65	16.05
2400	19.79	20.53	21.03	20.44	21.97	28.90	14.52
2500	19.53	20.20	20.64	20.32	22.03	29.41	13.84
2600	19.34	19.96	20.38	20.24	22.07	29.69	13.20
2700	19.04	19.58	19.95	20.05	21.99	29.39	12.59
2800	18.58	19.04	19.37	19.68	21.70	28.53	12.07
2900	18.19	18.60	18.88	19.37	21.43	27.46	11.78
3000	17.91	18.28	18.50	19.12	21.17	26.40	11.71
3200	17.35	17.67	17.76	18.59	20.53	24.02	11.67
3400	16.87	17.06	16.97	17.98	19.45	20.80	11.70
3600	16.85	16.84	16.58	17.64	18.48	18.28	11.46
3800	17.28	16.96	16.50	17.45	17.55	16.33	11.27
4000	17.21	16.78	16.26	16.98	16.76	15.28	10.91
4200	17.95	17.75	17.18	17.80	17.52	15.63	10.76
4400	19.66	19.74	18.89	19.56	19.00	16.12	11.22
4600	23.39	22.74	20.66	21.61	19.57	15.45	12.18
4800	32.54	24.94	21.28	22.66	18.82	14.19	13.39
5000	26.50	22.25	19.91	21.11	17.51	13.17	14.21

**Notes**

- A. Performance and quality attributes and conditions not expressly stated in this specification document are intended to be excluded and do not form a part of this specification document.
- B. Electrical specifications and performance data contained in this specification document are based on Mini-Circuit's applicable established test performance criteria and measurement instructions.
- C. The parts covered by this specification document are subject to Mini-Circuit's standard limited warranty and terms and conditions (collectively, "Standard Terms"). Purchasers of this part are entitled to the rights and benefits contained therein. For a full statement of the Standard Terms and the exclusive rights and remedies thereunder, please visit Mini-Circuit's website at [www.minicircuits.com/MC\\_Store/terms.jsp](http://www.minicircuits.com/MC_Store/terms.jsp)



# Digital Step Attenuator

# ZX76-15R5A-PN+

## Typical Performance Data

TEST CONDITIONS: INPUT POWER=0 dBm, Vdd=+3V, TEMPERATURE=-40°C

FREQUENCY (MHz)	OUTPUT RETURN LOSS AT TTL CONTROL STATE						
	(dB)						
	000000 0 dB	000001 0.5 dB	000010 1.0 dB	000100 2.0 dB	001000 4.0 dB	010000 8.0 dB	011111 15.5 dB
0.1	19.19	20.09	20.53	27.37	35.22	48.10	26.11
0.3	19.17	20.08	20.52	27.34	35.16	48.87	26.13
0.5	19.08	19.99	20.41	27.18	34.80	50.78	26.13
1	19.08	19.99	20.41	27.20	34.74	51.32	26.12
5	18.93	19.85	20.27	26.92	34.21	51.57	26.15
10	18.91	19.82	20.24	26.87	34.12	51.56	26.16
50	18.89	19.79	20.20	26.75	33.73	49.89	26.13
100	18.91	19.79	20.19	26.64	33.28	48.25	26.13
200	18.78	19.63	20.01	26.19	32.18	45.91	26.17
300	18.91	19.74	20.09	26.24	31.97	44.71	26.70
400	19.00	19.83	20.19	26.40	32.12	43.08	27.52
500	19.26	20.12	20.49	26.88	32.72	41.69	26.17
600	19.40	20.29	20.69	27.32	33.61	41.22	26.02
700	19.47	20.39	20.81	27.75	34.96	42.40	26.27
800	19.33	20.26	20.69	27.63	35.34	44.99	27.00
900	19.17	20.10	20.53	27.37	35.07	47.10	27.42
1000	18.98	19.89	20.32	26.94	34.20	48.26	26.71
1100	18.80	19.70	20.13	26.54	33.36	49.96	27.95
1200	18.87	19.77	20.19	26.65	33.52	50.40	28.70
1300	19.05	19.91	20.29	26.66	33.01	40.61	30.63
1400	19.07	19.84	20.14	26.12	31.20	38.69	30.51
1500	19.52	20.24	20.49	26.56	31.22	41.55	29.38
1600	19.56	20.23	20.45	26.38	30.67	40.21	28.63
1700	19.35	19.99	20.18	25.91	29.88	38.43	25.71
1800	19.32	19.87	20.03	25.42	28.66	35.92	22.56
1900	18.86	19.32	19.44	24.26	26.89	32.87	20.24
2000	18.69	19.10	19.19	23.66	25.90	32.13	18.80
2100	18.41	18.75	18.85	22.94	24.82	30.83	17.52
2200	18.00	18.29	18.40	22.12	23.78	29.46	16.42
2300	17.22	17.43	17.53	20.54	21.84	26.69	15.21
2400	16.71	16.89	17.00	19.40	20.41	24.87	14.49
2500	16.58	16.75	16.87	19.05	19.98	24.31	14.16
2600	16.44	16.60	16.74	18.73	19.61	23.78	13.90
2700	16.26	16.39	16.54	18.32	19.11	23.02	13.69
2800	16.04	16.16	16.32	17.85	18.55	22.15	13.38
2900	15.93	16.04	16.21	17.54	18.16	21.48	12.97
3000	15.75	15.86	16.04	17.22	17.79	20.89	12.61
3200	15.54	15.68	15.86	16.69	17.08	19.53	11.92
3400	15.77	15.90	16.06	16.47	16.60	18.32	11.61
3600	17.01	16.99	17.13	16.84	16.51	17.23	11.50
3800	19.28	19.16	19.17	17.74	16.82	16.49	11.38
4000	21.40	20.92	20.71	17.75	16.42	15.34	11.07
4200	21.67	20.78	20.41	16.83	15.47	14.11	11.51
4400	22.56	21.47	20.86	16.59	15.13	13.45	11.71
4600	25.28	23.42	22.35	16.80	15.07	12.90	11.97
4800	25.62	23.87	22.89	17.02	15.15	12.55	12.35
5000	21.48	20.87	20.46	16.23	14.59	11.90	12.70

**Notes**

- A. Performance and quality attributes and conditions not expressly stated in this specification document are intended to be excluded and do not form a part of this specification document.
- B. Electrical specifications and performance data contained in this specification document are based on Mini-Circuit's applicable established test performance criteria and measurement instructions.
- C. The parts covered by this specification document are subject to Mini-Circuit's standard limited warranty and terms and conditions (collectively, "Standard Terms"); Purchasers of this part are entitled to the rights and benefits contained therein. For a full statement of the Standard Terms and the exclusive rights and remedies thereunder, please visit Mini-Circuit's website at [www.minicircuits.com/MC\\_Store/terms.jsp](http://www.minicircuits.com/MC_Store/terms.jsp)



# Digital Step Attenuator

# ZX76-15R5A-PN+

## Typical Performance Data

TEST CONDITIONS: INPUT POWER=0 dBm, Vdd=+3V, TEMPERATURE=+25°C

FREQUENCY (MHz)	STEP ATTENUATION* AT TTL CONTROL STATE						
	(dB)						
	000000 THRU LOSS	000001 0.5 dB	000010 1.0 dB	000100 2.0 dB	001000 4.0 dB	010000 8.0 dB	011111 15.5 dB
0.1	1.21	0.04	1.01	2.01	4.00	7.97	15.46
0.3	1.22	0.04	1.01	2.01	4.00	7.97	15.46
0.5	1.22	0.03	1.01	2.01	4.00	7.97	15.46
1	1.23	0.03	1.01	2.01	4.00	7.97	15.46
5	1.23	0.03	1.01	2.01	4.00	7.97	15.47
10	1.24	0.03	1.01	2.01	4.00	7.97	15.47
50	1.25	0.03	1.01	2.01	4.00	7.97	15.47
100	1.27	0.03	1.01	2.01	4.00	7.97	15.46
200	1.31	0.03	1.01	2.01	4.00	7.97	15.45
300	1.34	0.03	1.01	2.01	4.00	7.97	15.45
400	1.38	0.03	1.01	2.00	3.99	7.97	15.45
500	1.42	0.03	1.01	2.00	3.99	7.97	15.44
600	1.46	0.03	1.00	2.00	3.99	7.97	15.44
700	1.49	0.03	1.00	2.00	3.99	7.97	15.44
800	1.54	0.03	1.00	2.00	3.99	7.97	15.44
900	1.57	0.03	1.00	1.99	3.98	7.97	15.45
1000	1.61	0.03	1.00	1.99	3.98	7.98	15.45
1100	1.65	0.03	1.00	1.99	3.98	7.98	15.46
1200	1.69	0.03	1.00	1.99	3.98	7.99	15.46
1300	1.73	0.03	1.00	1.99	3.98	7.99	15.47
1400	1.77	0.03	1.00	1.99	3.98	8.00	15.49
1500	1.81	0.03	1.00	1.99	3.98	8.00	15.52
1600	1.85	0.03	1.00	1.99	3.98	8.01	15.55
1700	1.89	0.03	1.00	1.99	3.98	8.01	15.59
1800	1.93	0.02	1.00	1.99	3.98	8.02	15.63
1900	1.98	0.02	1.00	1.99	3.98	8.02	15.69
2000	2.02	0.02	1.00	1.99	3.98	8.02	15.75
2100	2.07	0.02	1.00	1.99	3.98	8.02	15.83
2200	2.11	0.03	1.00	1.99	3.97	8.03	15.82
2300	2.15	0.03	1.00	1.99	3.97	8.03	15.86
2400	2.19	0.03	1.00	2.00	3.97	8.04	15.96
2500	2.23	0.03	1.00	2.00	3.97	8.05	16.06
2600	2.26	0.04	1.01	2.00	3.98	8.06	16.18
2700	2.29	0.04	1.01	2.00	3.98	8.08	16.35
2800	2.32	0.04	1.01	2.01	3.98	8.10	16.50
2900	2.35	0.04	1.02	2.01	3.99	8.12	16.59
3000	2.37	0.04	1.02	2.02	4.00	8.15	16.62
3200	2.41	0.04	1.03	2.04	4.03	8.23	16.65
3400	2.43	0.04	1.05	2.07	4.07	8.34	16.72
3600	2.44	0.04	1.07	2.10	4.13	8.46	16.79
3800	2.46	0.04	1.08	2.13	4.17	8.57	16.84
4000	2.52	0.05	1.08	2.15	4.20	8.69	16.91
4200	2.67	0.07	1.08	2.16	4.23	8.81	16.91
4400	2.93	0.08	1.07	2.16	4.25	8.93	17.00
4600	3.14	0.08	1.08	2.18	4.28	9.07	17.35
4800	3.12	0.08	1.09	2.18	4.29	9.17	17.67
5000	3.11	0.08	1.07	2.14	4.24	9.22	18.10

\* Step Attenuation above Thru Loss (TTL Logic 00000).

**Notes**

- A. Performance and quality attributes and conditions not expressly stated in this specification document are intended to be excluded and do not form a part of this specification document.
- B. Electrical specifications and performance data contained in this specification document are based on Mini-Circuit's applicable established test performance criteria and measurement instructions.
- C. The parts covered by this specification document are subject to Mini-Circuit's standard limited warranty and terms and conditions (collectively, "Standard Terms"); Purchasers of this part are entitled to the rights and benefits contained therein. For a full statement of the Standard Terms and the exclusive rights and remedies thereunder, please visit Mini-Circuit's website at [www.minicircuits.com/MC\\_Store/terms.jsp](http://www.minicircuits.com/MC_Store/terms.jsp)



# Digital Step Attenuator

# ZX76-15R5A-PN+

## Typical Performance Data

TEST CONDITIONS: INPUT POWER=0 dBm, Vdd=+3V, TEMPERATURE=+25°C

FREQUENCY (MHz)	INPUT RETURN LOSS AT TTL CONTROL STATE						
	(dB)						
	000000 0 dB	000001 0.5 dB	000010 1.0 dB	000100 2.0 dB	001000 4.0 dB	010000 8.0 dB	011111 15.5 dB
0.1	18.79	20.34	21.87	19.97	21.00	24.11	28.22
0.3	18.77	20.32	21.84	19.96	20.99	24.08	28.22
0.5	18.76	20.31	21.83	19.90	20.88	23.85	28.26
1	18.66	20.23	21.75	19.81	20.79	23.77	28.28
5	18.56	20.12	21.64	19.74	20.75	23.75	28.47
10	18.54	20.10	21.62	19.72	20.73	23.73	28.44
50	18.55	20.11	21.62	19.73	20.73	23.72	28.48
100	18.57	20.12	21.63	19.74	20.74	23.72	28.45
200	18.59	20.15	21.66	19.77	20.78	23.77	28.48
300	18.64	20.19	21.69	19.79	20.76	23.70	28.44
400	18.58	20.12	21.61	19.73	20.70	23.60	28.44
500	18.59	20.12	21.60	19.72	20.68	23.53	28.34
600	18.53	20.05	21.51	19.65	20.59	23.39	28.26
700	18.54	20.05	21.51	19.64	20.58	23.35	27.90
800	18.53	20.03	21.49	19.63	20.56	23.28	27.46
900	18.59	20.09	21.54	19.66	20.56	23.23	26.66
1000	18.60	20.08	21.51	19.63	20.49	23.06	25.71
1100	18.45	19.92	21.32	19.48	20.32	22.83	25.00
1200	18.44	19.89	21.29	19.44	20.26	22.73	24.12
1300	18.21	19.58	20.87	19.05	19.74	21.82	23.14
1400	18.09	19.40	20.60	18.75	19.30	21.07	22.22
1500	18.15	19.41	20.56	18.61	19.03	20.58	21.55
1600	18.11	19.31	20.38	18.36	18.64	20.01	20.90
1700	18.16	19.28	20.28	18.17	18.34	19.58	20.26
1800	17.98	19.01	19.90	17.82	17.94	19.18	19.79
1900	18.03	18.96	19.75	17.70	17.77	19.05	19.36
2000	17.60	18.38	19.05	17.24	17.36	18.73	18.67
2100	16.90	17.54	18.08	16.65	16.86	18.38	17.86
2200	16.33	16.85	17.27	16.23	16.59	18.37	17.35
2300	15.93	16.36	16.71	16.03	16.57	18.71	16.25
2400	15.47	15.84	16.12	15.79	16.55	19.11	14.89
2500	14.99	15.31	15.56	15.43	16.28	19.00	14.24
2600	14.73	15.02	15.24	15.28	16.22	19.14	13.67
2700	14.46	14.72	14.91	15.11	16.15	19.22	13.19
2800	14.41	14.63	14.78	15.16	16.30	19.58	12.82
2900	14.20	14.40	14.52	15.04	16.25	19.57	12.61
3000	14.15	14.32	14.40	15.05	16.33	19.67	12.54
3200	14.14	14.26	14.27	15.15	16.50	19.59	12.53
3400	13.84	13.87	13.79	14.80	15.96	18.09	12.64
3600	13.76	13.70	13.54	14.57	15.47	16.70	12.60
3800	13.84	13.66	13.41	14.37	14.90	15.22	12.35
4000	13.77	13.60	13.30	14.15	14.51	14.49	12.26
4200	14.90	14.63	14.12	15.01	15.08	14.38	12.49
4400	17.09	16.42	15.50	16.56	16.02	14.28	13.61
4600	21.93	19.84	17.97	19.40	17.50	14.24	15.13
4800	24.89	20.88	18.59	19.88	17.09	13.37	16.35
5000	22.12	19.52	17.97	18.84	16.24	12.62	15.75

**Notes**

- A. Performance and quality attributes and conditions not expressly stated in this specification document are intended to be excluded and do not form a part of this specification document.
- B. Electrical specifications and performance data contained in this specification document are based on Mini-Circuit's applicable established test performance criteria and measurement instructions.
- C. The parts covered by this specification document are subject to Mini-Circuit's standard limited warranty and terms and conditions (collectively, "Standard Terms"). Purchasers of this part are entitled to the rights and benefits contained therein. For a full statement of the Standard Terms and the exclusive rights and remedies thereunder, please visit Mini-Circuit's website at [www.minicircuits.com/MC\\_Store/terms.jsp](http://www.minicircuits.com/MC_Store/terms.jsp)



# Digital Step Attenuator

# ZX76-15R5A-PN+

## Typical Performance Data

TEST CONDITIONS: INPUT POWER=0 dBm, Vdd=+3V, TEMPERATURE=+25°C

FREQUENCY (MHz)	OUTPUT RETURN LOSS AT TTL CONTROL STATE						
	(dB)						
	000000 0 dB	000001 0.5 dB	000010 1.0 dB	000100 2.0 dB	001000 4.0 dB	010000 8.0 dB	011111 15.5 dB
0.1	18.63	19.24	19.43	24.48	28.24	32.18	52.48
0.3	18.62	19.23	19.42	24.47	28.22	32.16	53.12
0.5	18.52	19.13	19.32	24.32	27.99	31.69	52.40
1	18.51	19.13	19.30	24.34	27.99	31.68	52.93
5	18.41	19.03	19.22	24.21	27.88	31.63	53.10
10	18.39	19.02	19.21	24.20	27.86	31.61	54.08
50	18.42	19.06	19.24	24.24	27.90	31.66	53.47
100	18.52	19.15	19.33	24.35	28.02	31.76	53.68
200	18.49	19.12	19.30	24.30	27.94	31.64	53.34
300	18.54	19.16	19.34	24.31	27.88	31.38	52.52
400	18.42	19.03	19.22	24.10	27.58	30.96	50.27
500	18.53	19.14	19.32	24.22	27.69	30.98	63.15
600	18.55	19.16	19.33	24.22	27.66	30.82	60.04
700	18.51	19.11	19.28	24.10	27.46	30.44	50.38
800	18.50	19.10	19.27	24.06	27.37	30.24	44.39
900	18.49	19.09	19.25	24.00	27.23	29.92	39.27
1000	18.49	19.07	19.23	23.92	27.04	29.56	35.53
1100	18.47	19.06	19.21	23.87	26.96	29.35	32.36
1200	18.46	19.04	19.17	23.77	26.75	28.93	29.64
1300	18.43	18.96	19.05	23.40	25.97	27.52	27.38
1400	18.39	18.85	18.89	22.97	25.11	26.12	25.48
1500	18.34	18.74	18.72	22.59	24.36	25.04	23.76
1600	18.40	18.71	18.61	22.30	23.71	24.18	22.28
1700	18.46	18.67	18.51	22.00	23.04	23.42	20.94
1800	18.58	18.67	18.45	21.69	22.41	22.87	19.70
1900	18.33	18.34	18.09	21.00	21.52	22.19	18.57
2000	18.20	18.12	17.86	20.45	20.84	21.81	17.56
2100	17.83	17.70	17.49	19.67	20.05	21.47	16.71
2200	17.11	16.99	16.87	18.66	19.11	21.03	16.04
2300	16.41	16.32	16.28	17.75	18.29	20.67	15.46
2400	15.72	15.67	15.72	16.89	17.52	20.32	15.03
2500	15.20	15.20	15.30	16.34	17.04	20.03	14.84
2600	14.80	14.83	14.97	15.91	16.67	19.79	14.65
2700	14.49	14.54	14.72	15.57	16.35	19.60	14.43
2800	14.20	14.29	14.49	15.28	16.08	19.41	14.17
2900	14.01	14.12	14.34	15.05	15.85	19.21	13.82
3000	13.84	13.97	14.21	14.84	15.64	18.99	13.51
3200	13.83	13.99	14.25	14.70	15.43	18.63	13.01
3400	14.11	14.30	14.57	14.82	15.45	18.35	12.74
3600	15.04	15.21	15.47	15.34	15.71	17.97	12.53
3800	16.46	16.58	16.82	16.02	16.03	17.36	12.38
4000	17.39	17.45	17.64	16.09	15.76	16.18	12.34
4200	18.27	18.22	18.28	16.04	15.41	15.13	12.81
4400	20.26	20.04	19.89	16.55	15.52	14.51	13.54
4600	25.03	23.82	22.99	17.41	15.83	13.96	14.53
4800	27.89	25.53	24.21	17.70	15.80	13.28	15.23
5000	22.61	21.91	21.47	17.10	15.42	12.68	15.37

**Notes**

- A. Performance and quality attributes and conditions not expressly stated in this specification document are intended to be excluded and do not form a part of this specification document.
- B. Electrical specifications and performance data contained in this specification document are based on Mini-Circuit's applicable established test performance criteria and measurement instructions.
- C. The parts covered by this specification document are subject to Mini-Circuit's standard limited warranty and terms and conditions (collectively, "Standard Terms"). Purchasers of this part are entitled to the rights and benefits contained therein. For a full statement of the Standard Terms and the exclusive rights and remedies thereunder, please visit Mini-Circuit's website at [www.minicircuits.com/MC\\_Store/terms.jsp](http://www.minicircuits.com/MC_Store/terms.jsp)



# Digital Step Attenuator

# ZX76-15R5A-PN+

## Typical Performance Data

TEST CONDITIONS: INPUT POWER=0 dBm, Vdd=+3V, TEMPERATURE=+85°C

FREQUENCY (MHz)	STEP ATTENUATION* AT TTL CONTROL STATE						
	(dB)						
	000000 THRU LOSS	000001 0.5 dB	000010 1.0 dB	000100 2.0 dB	001000 4.0 dB	010000 8.0 dB	011111 15.5 dB
0.1	1.22	0.52	1.02	2.01	4.00	7.92	15.32
0.3	1.23	0.52	1.02	2.01	4.00	7.92	15.32
0.5	1.25	0.52	1.02	2.01	3.99	7.90	15.32
1	1.27	0.52	1.02	2.01	3.99	7.89	15.33
5	1.26	0.52	1.02	2.01	3.99	7.90	15.34
10	1.26	0.52	1.02	2.01	3.99	7.90	15.34
50	1.26	0.52	1.02	2.01	3.99	7.90	15.34
100	1.26	0.52	1.02	2.01	3.99	7.90	15.33
200	1.30	0.52	1.02	2.01	3.99	7.90	15.31
300	1.29	0.52	1.02	2.01	3.99	7.90	15.31
400	1.31	0.52	1.02	2.01	4.00	7.90	15.32
500	1.34	0.52	1.02	2.01	3.99	7.90	15.32
600	1.34	0.52	1.02	2.01	3.99	7.90	15.31
700	1.38	0.52	1.02	2.01	3.99	7.90	15.31
800	1.38	0.52	1.02	2.01	3.99	7.90	15.31
900	1.41	0.52	1.02	2.01	3.99	7.90	15.31
1000	1.43	0.52	1.02	2.01	3.99	7.90	15.32
1100	1.43	0.52	1.02	2.01	3.99	7.90	15.33
1200	1.47	0.52	1.02	2.01	3.99	7.90	15.34
1300	1.56	0.52	1.02	2.01	3.99	7.91	15.35
1400	1.65	0.51	1.02	2.01	3.99	7.92	15.38
1500	1.74	0.51	1.02	2.01	3.99	7.93	15.41
1600	1.83	0.51	1.02	2.01	4.00	7.95	15.44
1700	1.92	0.51	1.02	2.01	4.00	7.96	15.47
1800	2.01	0.51	1.02	2.02	4.01	7.98	15.51
1900	2.10	0.51	1.02	2.02	4.01	8.00	15.56
2000	2.20	0.52	1.02	2.02	4.01	8.02	15.62
2100	2.29	0.52	1.02	2.03	4.02	8.04	15.68
2200	2.38	0.52	1.03	2.03	4.02	8.06	15.68
2300	2.47	0.52	1.03	2.04	4.02	8.09	15.77
2400	2.55	0.52	1.03	2.04	4.02	8.11	15.91
2500	2.59	0.53	1.03	2.04	4.02	8.12	16.03
2600	2.64	0.53	1.03	2.04	4.03	8.14	16.16
2700	2.68	0.53	1.04	2.05	4.03	8.15	16.31
2800	2.72	0.53	1.04	2.05	4.03	8.17	16.41
2900	2.77	0.53	1.04	2.05	4.03	8.19	16.45
3000	2.82	0.53	1.04	2.06	4.03	8.21	16.45
3200	2.89	0.54	1.04	2.07	4.04	8.24	16.42
3400	3.00	0.54	1.04	2.09	4.05	8.30	16.35
3600	3.17	0.54	1.05	2.09	4.07	8.39	16.28
3800	3.38	0.54	1.06	2.12	4.13	8.53	16.39
4000	3.47	0.55	1.08	2.16	4.18	8.68	16.72
4200	3.36	0.56	1.11	2.20	4.24	8.83	16.91
4400	3.28	0.58	1.13	2.23	4.30	9.01	17.01
4600	3.32	0.58	1.13	2.25	4.34	9.18	17.25
4800	3.49	0.58	1.12	2.25	4.34	9.30	17.50
5000	3.74	0.57	1.10	2.23	4.33	9.40	17.89

\* Step Attenuation above Thru Loss (TTL Logic 00000).

**Notes**

- A. Performance and quality attributes and conditions not expressly stated in this specification document are intended to be excluded and do not form a part of this specification document.
- B. Electrical specifications and performance data contained in this specification document are based on Mini-Circuit's applicable established test performance criteria and measurement instructions.
- C. The parts covered by this specification document are subject to Mini-Circuit's standard limited warranty and terms and conditions (collectively, "Standard Terms"). Purchasers of this part are entitled to the rights and benefits contained therein. For a full statement of the Standard Terms and the exclusive rights and remedies thereunder, please visit Mini-Circuit's website at [www.minicircuits.com/MC\\_Store/terms.jsp](http://www.minicircuits.com/MC_Store/terms.jsp)





# Digital Step Attenuator

# ZX76-15R5A-PN+

## Typical Performance Data

TEST CONDITIONS: INPUT POWER=0 dBm, Vdd=+3V, TEMPERATURE=+85°C

FREQUENCY (MHz)	INPUT RETURN LOSS AT TTL CONTROL STATE						
	(dB)						
	000000 0 dB	000001 0.5 dB	000010 1.0 dB	000100 2.0 dB	001000 4.0 dB	010000 8.0 dB	011111 15.5 dB
0.1	18.17	19.34	20.32	18.20	18.45	19.87	21.45
0.3	18.16	19.34	20.31	18.19	18.44	19.85	21.45
0.5	18.15	19.32	20.30	18.14	18.37	19.75	21.45
1	18.06	19.26	20.24	18.09	18.32	19.73	21.47
5	17.96	19.15	20.14	18.04	18.30	19.74	21.53
10	17.94	19.14	20.12	18.03	18.29	19.73	21.54
50	17.94	19.14	20.12	18.04	18.32	19.77	21.59
100	17.94	19.14	20.13	18.06	18.35	19.84	21.58
200	17.92	19.14	20.15	18.12	18.45	19.98	21.61
300	17.92	19.15	20.18	18.17	18.54	20.14	21.78
400	17.91	19.15	20.21	18.23	18.62	20.26	22.09
500	17.96	19.19	20.25	18.27	18.63	20.20	22.28
600	17.96	19.18	20.21	18.22	18.54	20.05	21.65
700	17.97	19.16	20.18	18.18	18.46	19.90	21.49
800	17.87	19.03	20.01	18.02	18.27	19.61	21.08
900	17.85	18.98	19.93	17.93	18.15	19.42	20.60
1000	17.82	18.93	19.85	17.83	18.01	19.23	20.05
1100	17.67	18.74	19.62	17.63	17.81	18.98	19.59
1200	17.62	18.68	19.54	17.56	17.72	18.87	19.01
1300	17.58	18.60	19.35	17.32	17.37	18.31	18.34
1400	17.46	18.42	19.12	17.04	16.96	17.70	17.66
1500	17.47	18.37	19.02	16.84	16.64	17.23	17.11
1600	17.53	18.37	18.95	16.71	16.41	16.89	16.59
1700	17.65	18.43	18.93	16.65	16.27	16.68	16.16
1800	17.63	18.33	18.77	16.53	16.15	16.58	15.91
1900	17.47	18.07	18.43	16.34	15.96	16.45	15.80
2000	17.09	17.59	17.86	16.07	15.79	16.40	15.57
2100	16.65	17.05	17.26	15.81	15.66	16.44	15.31
2200	16.08	16.41	16.58	15.50	15.52	16.55	15.19
2300	15.42	15.68	15.81	15.12	15.33	16.66	14.53
2400	14.86	15.07	15.15	14.84	15.26	16.92	13.48
2500	14.65	14.84	14.90	14.77	15.31	17.19	12.93
2600	14.49	14.67	14.71	14.74	15.40	17.52	12.46
2700	14.37	14.53	14.55	14.74	15.52	17.91	12.08
2800	14.17	14.33	14.33	14.66	15.56	18.18	11.81
2900	13.95	14.09	14.07	14.56	15.57	18.42	11.66
3000	13.78	13.89	13.87	14.50	15.60	18.66	11.58
3200	13.65	13.69	13.62	14.56	15.81	19.05	11.35
3400	13.64	13.60	13.46	14.61	15.85	18.64	10.81
3600	13.68	13.56	13.32	14.53	15.62	17.54	9.73
3800	13.42	13.23	12.92	14.08	14.93	16.05	8.49
4000	13.27	13.08	12.72	13.81	14.45	15.07	8.41
4200	14.36	14.07	13.53	14.67	15.02	14.87	9.30
4400	16.94	16.24	15.27	16.71	16.38	14.84	10.96
4600	20.89	18.96	17.28	19.05	17.44	14.43	13.71
4800	23.44	20.20	18.32	19.65	17.21	13.62	17.84
5000	20.80	18.90	17.80	18.42	16.32	12.92	22.11

**Notes**

- A. Performance and quality attributes and conditions not expressly stated in this specification document are intended to be excluded and do not form a part of this specification document.
- B. Electrical specifications and performance data contained in this specification document are based on Mini-Circuit's applicable established test performance criteria and measurement instructions.
- C. The parts covered by this specification document are subject to Mini-Circuit's standard limited warranty and terms and conditions (collectively, "Standard Terms"). Purchasers of this part are entitled to the rights and benefits contained therein. For a full statement of the Standard Terms and the exclusive rights and remedies thereunder, please visit Mini-Circuit's website at [www.minicircuits.com/MC\\_Store/terms.jsp](http://www.minicircuits.com/MC_Store/terms.jsp)





# Digital Step Attenuator

# ZX76-15R5A-PN+

## Typical Performance Data

TEST CONDITIONS: INPUT POWER=0 dBm, Vdd=+3V, TEMPERATURE=+85°C

FREQUENCY (MHz)	OUTPUT RETURN LOSS AT TTL CONTROL STATE						
	(dB)						
	000000 0 dB	000001 0.5 dB	000010 1.0 dB	000100 2.0 dB	001000 4.0 dB	010000 8.0 dB	011111 15.5 dB
0.1	19.19	18.36	18.23	21.73	23.27	23.97	27.23
0.3	19.17	18.35	18.22	21.72	23.25	23.94	27.19
0.5	19.08	18.26	18.14	21.63	23.14	23.81	27.21
1	19.08	18.27	18.14	21.65	23.16	23.82	27.22
5	18.93	18.20	18.08	21.58	23.13	23.86	27.25
10	18.91	18.18	18.07	21.57	23.12	23.86	27.22
50	18.89	18.25	18.14	21.66	23.24	24.00	27.30
100	18.91	18.40	18.28	21.87	23.47	24.25	27.32
200	18.78	18.52	18.42	22.12	23.81	24.69	27.35
300	18.91	18.69	18.59	22.37	24.14	25.06	27.55
400	19.00	18.59	18.51	22.25	24.05	25.01	28.22
500	19.26	18.48	18.39	22.01	23.71	24.55	28.26
600	19.40	18.26	18.16	21.64	23.24	24.01	26.90
700	19.47	18.12	18.01	21.36	22.88	23.57	26.56
800	19.33	18.04	17.91	21.18	22.61	23.21	25.60
900	19.17	18.10	17.95	21.22	22.60	23.13	24.99
1000	18.98	18.14	17.99	21.23	22.56	23.02	24.26
1100	18.80	18.16	18.00	21.24	22.53	22.93	23.42
1200	18.87	18.26	18.09	21.34	22.60	22.92	22.41
1300	19.05	18.02	17.84	20.82	21.78	21.79	21.40
1400	19.07	17.95	17.69	20.50	21.18	20.93	20.32
1500	19.52	17.87	17.55	20.18	20.59	20.17	19.29
1600	19.56	17.88	17.49	19.96	20.13	19.63	18.37
1700	19.35	17.83	17.38	19.64	19.62	19.15	17.55
1800	19.32	17.67	17.19	19.23	19.10	18.78	16.81
1900	18.86	17.45	16.97	18.78	18.59	18.50	16.12
2000	18.69	17.17	16.72	18.27	18.12	18.35	15.53
2100	18.41	16.76	16.37	17.67	17.61	18.21	15.08
2200	18.00	16.29	15.98	17.05	17.11	18.16	14.77
2300	17.22	15.76	15.58	16.44	16.66	18.21	14.57
2400	16.71	15.21	15.15	15.85	16.23	18.32	14.47
2500	16.58	14.92	14.91	15.53	15.98	18.32	14.43
2600	16.44	14.63	14.66	15.21	15.73	18.32	14.38
2700	16.26	14.39	14.46	14.94	15.52	18.33	14.27
2800	16.04	14.14	14.25	14.68	15.31	18.34	14.13
2900	15.93	13.93	14.09	14.45	15.13	18.37	13.90
3000	15.75	13.76	13.95	14.25	14.98	18.40	13.73
3200	15.54	13.78	14.00	14.16	14.87	18.47	13.43
3400	15.77	14.11	14.34	14.25	14.93	18.58	13.27
3600	17.01	14.78	15.03	14.64	15.23	18.70	13.10
3800	19.28	16.01	16.28	15.29	15.64	18.30	13.09
4000	21.40	16.72	16.96	15.36	15.50	17.18	13.40
4200	21.67	17.51	17.69	15.53	15.42	16.20	14.41
4400	22.56	19.78	19.84	16.44	15.90	15.59	16.21
4600	25.28	24.29	23.81	17.81	16.62	15.00	18.63
4800	25.62	26.00	24.89	18.42	16.81	14.20	20.22
5000	21.48	21.95	21.71	18.06	16.62	13.56	18.98

**Notes**

- A. Performance and quality attributes and conditions not expressly stated in this specification document are intended to be excluded and do not form a part of this specification document.
- B. Electrical specifications and performance data contained in this specification document are based on Mini-Circuit's applicable established test performance criteria and measurement instructions.
- C. The parts covered by this specification document are subject to Mini-Circuit's standard limited warranty and terms and conditions (collectively, "Standard Terms"); Purchasers of this part are entitled to the rights and benefits contained therein. For a full statement of the Standard Terms and the exclusive rights and remedies thereunder, please visit Mini-Circuit's website at [www.minicircuits.com/MC\\_Store/terms.jsp](http://www.minicircuits.com/MC_Store/terms.jsp)



# Digital Step Attenuator

## Typical Performance Curves

# ZX76-31A-PN+

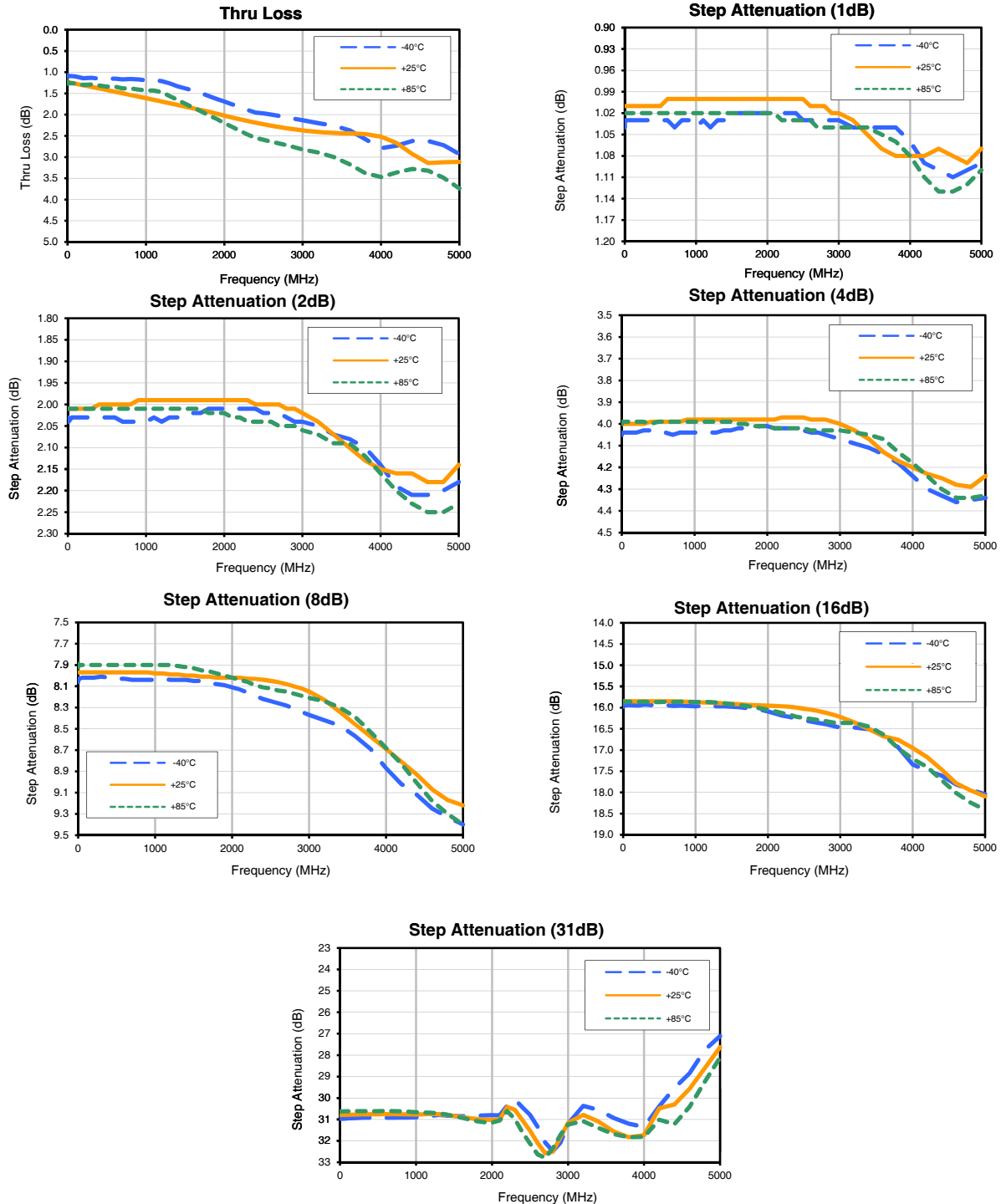

**Notes**

- A. Performance and quality attributes and conditions not expressly stated in this specification document are intended to be excluded and do not form a part of this specification document.
- B. Electrical specifications and performance data contained in this specification document are based on Mini-Circuits' applicable established test performance criteria and measurement instructions.
- C. The parts covered by this specification document are subject to Mini-Circuits' standard limited warranty and terms and conditions (collectively, "Standard Terms"); Purchasers of this part are entitled to the rights and benefits contained therein. For a full statement of the Standard Terms and the exclusive rights and remedies thereunder, please visit Mini-Circuits' website at [www.minicircuits.com/MCLStore/terms.jsp](http://www.minicircuits.com/MCLStore/terms.jsp)



# Digital Step Attenuator

## Typical Performance Curves

# ZX76-31A-PN+

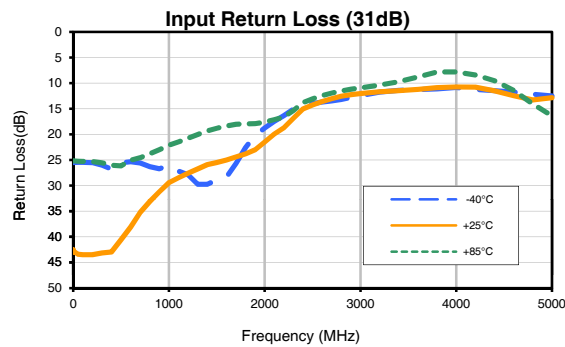
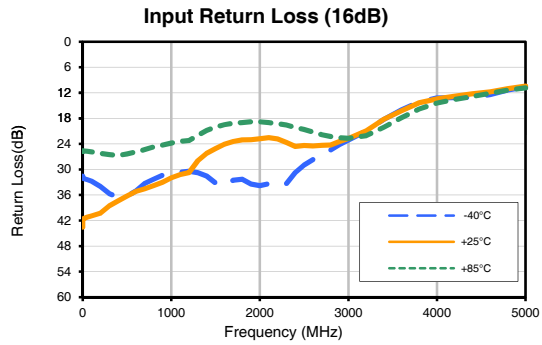
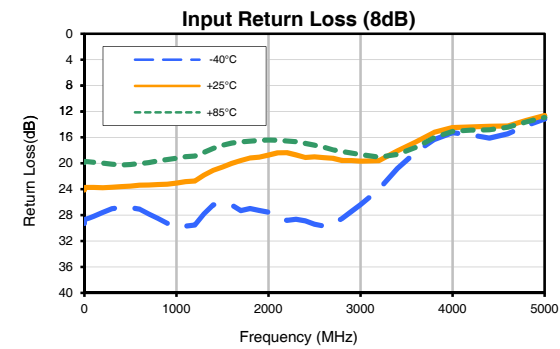
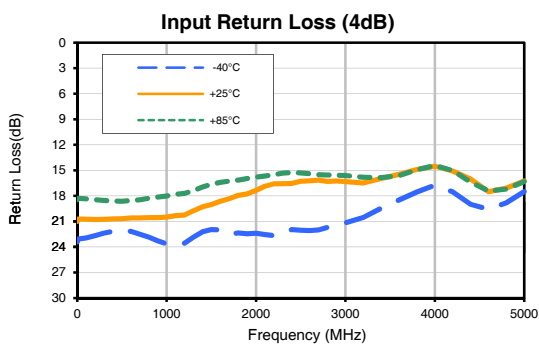
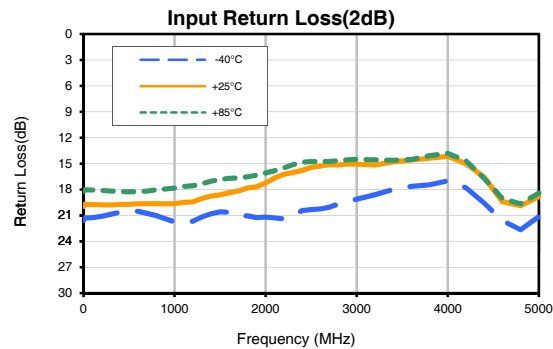
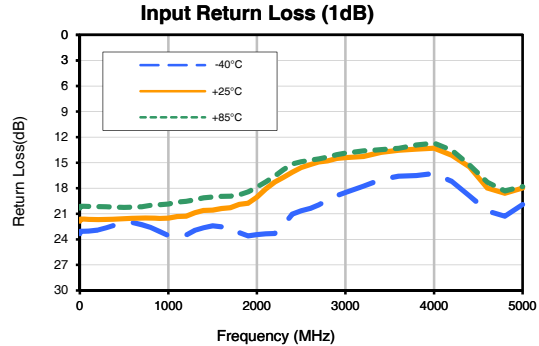
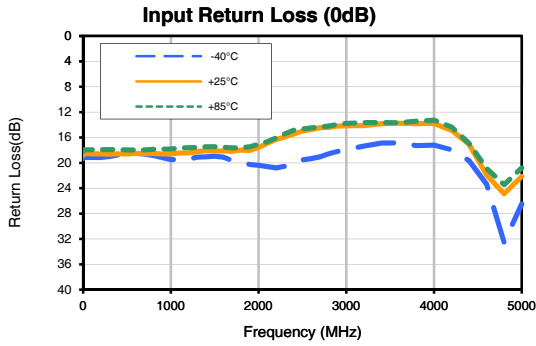

**Notes**

- A. Performance and quality attributes and conditions not expressly stated in this specification document are intended to be excluded and do not form a part of this specification document.
- B. Electrical specifications and performance data contained in this specification document are based on Mini-Circuits' applicable established test performance criteria and measurement instructions.
- C. The parts covered by this specification document are subject to Mini-Circuits' standard limited warranty and terms and conditions (collectively, "Standard Terms"). Purchasers of this part are entitled to the rights and benefits contained therein. For a full statement of the Standard Terms and the exclusive rights and remedies thereunder, please visit Mini-Circuits' website at [www.minicircuits.com/MCLStore/terms.jsp](http://www.minicircuits.com/MCLStore/terms.jsp)



# Digital Step Attenuator

# ZX76-31A-PN+

## Typical Performance Curves

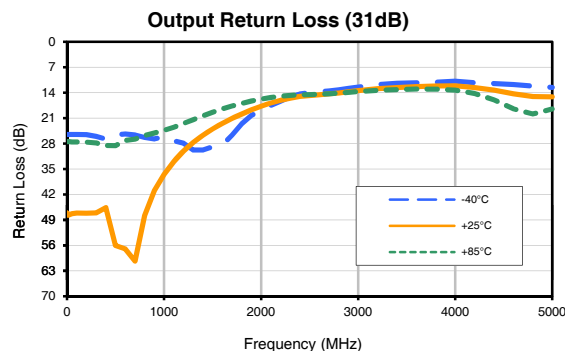
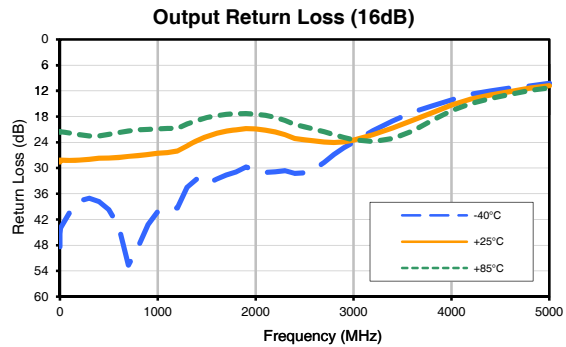
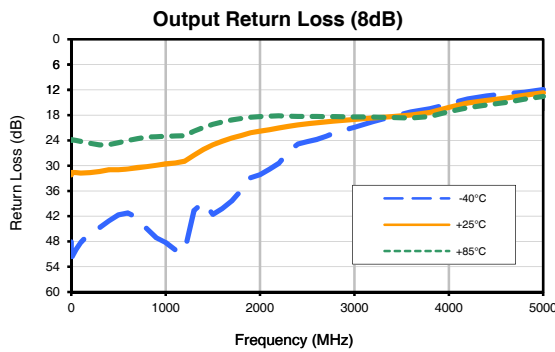
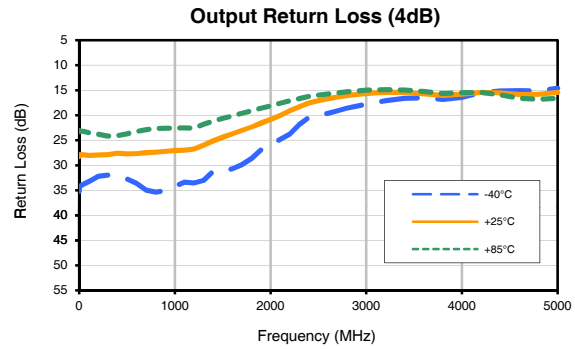
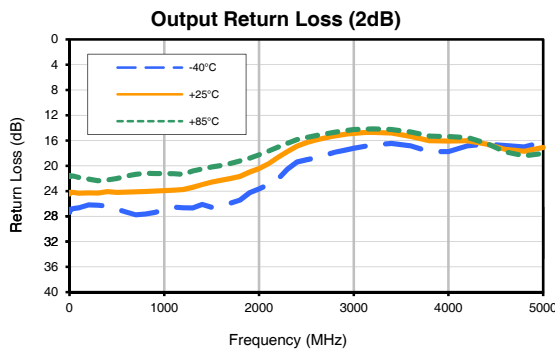
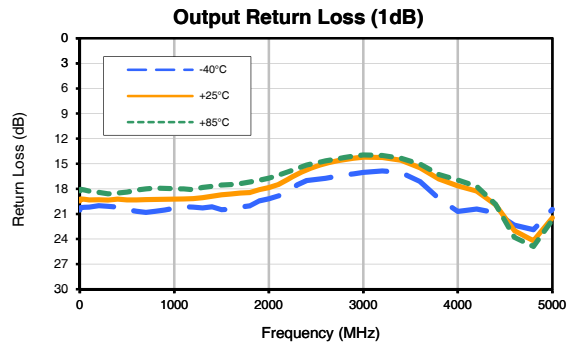
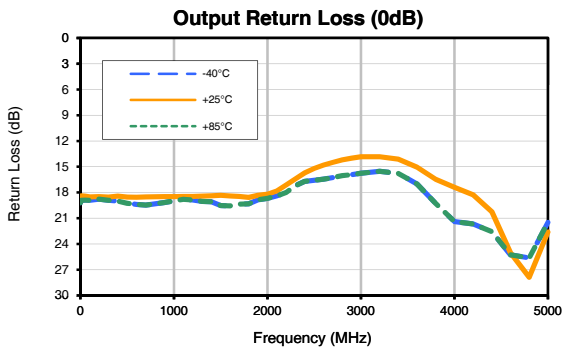

### Notes

- A. Performance and quality attributes and conditions not expressly stated in this specification document are intended to be excluded and do not form a part of this specification document.
- B. Electrical specifications and performance data contained in this specification document are based on Mini-Circuits' applicable established test performance criteria and measurement instructions.
- C. The parts covered by this specification document are subject to Mini-Circuits' standard limited warranty and terms and conditions (collectively, "Standard Terms"). Purchasers of this part are entitled to the rights and benefits contained therein. For a full statement of the Standard Terms and the exclusive rights and remedies thereunder, please visit Mini-Circuits' website at [www.minicircuits.com/MCLStore/terms.jsp](http://www.minicircuits.com/MCLStore/terms.jsp)



# Case Style

# HK

## Outline Dimensions

## HK1149

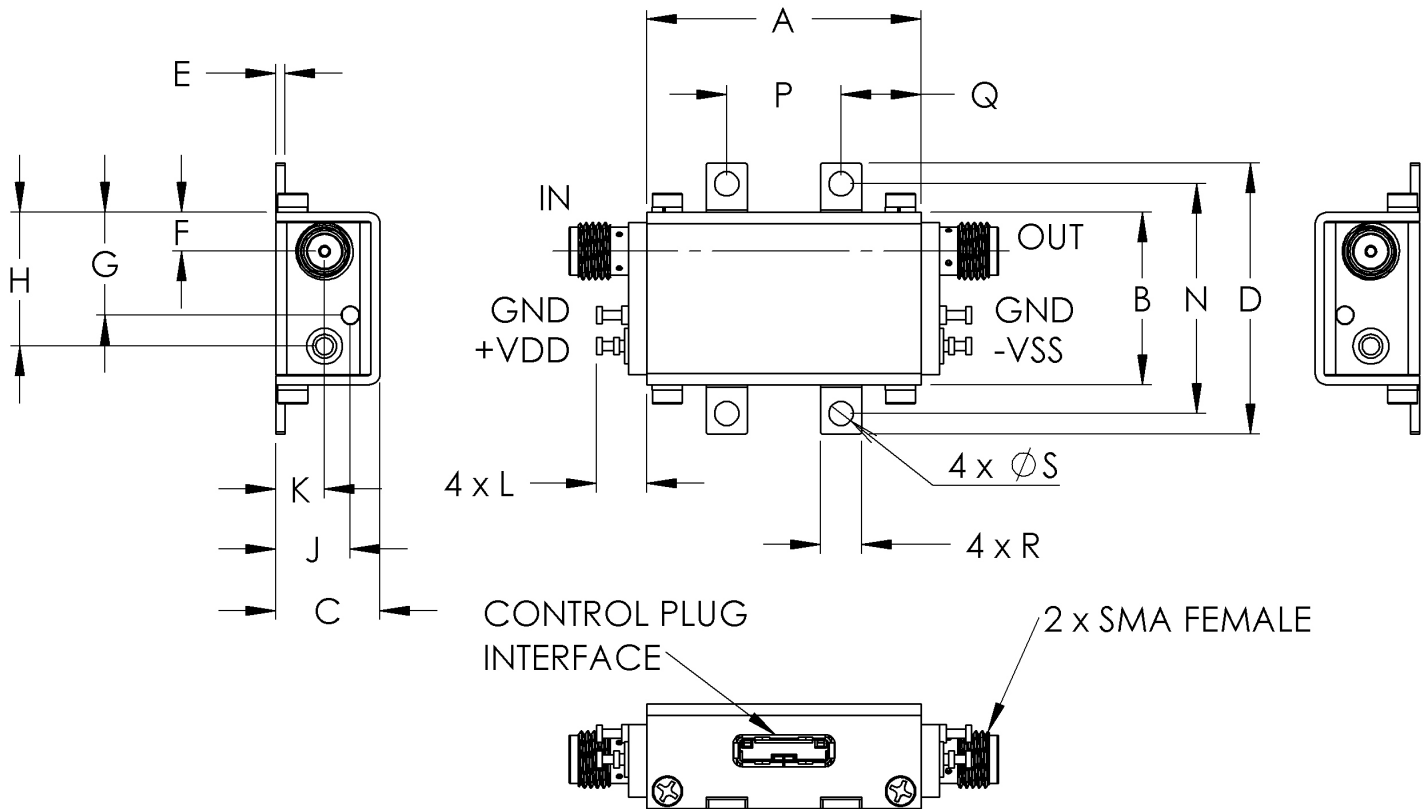

CASE #.	A	B	C	D	E	F	G	H	J	K	L	M	N
HK1149	1.20 (30.48)	.75 (19.15)	.46 (11.61)	1.18 (30.07)	.04 (1.02)	.17 (4.32)	.45 (11.40)	.59 (14.86)	.33 (8.31)	.21 (5.44)	.22 (5.59)	-	1.00 (25.4)

CASE #.	P	Q	R	S	WT GRAMS
HK1149	.50 (12.70)	.35 (8.89)	.18 (4.57)	.106 (2.69)	35

Dimensions are in inches (mm). Tolerances: 2Pl.  $\pm .03$ ; 3Pl.  $\pm .015$   
Tolerance on hole size and interaxes dimensions to be  $\pm .005$ .

### Note:

1. Case material: Brass
2. Case finish: Nickel plate

**Mini-Circuits**<sup>®</sup>

Distribution Centers NORTH AMERICA 800-654-7949 • 417-335-5935 • Fax 417-335-5945 • EUROPE 44-1252-832600 • Fax 44-1252-837010

Mini-Circuits ISO 9001 & ISO 14001 Certified

INTERNET <http://www.minicircuits.com>

P.O. Box 350166, Brooklyn, New York 11235-0003 (718) 934-4500 Fax (718) 332-4661

All Mini-Circuits products are manufactured under exacting quality assurance and control standards, and are capable of meeting published specifications after being subjected to any or all of the following physical and environmental test.

<b>Specification</b>	<b>Test/Inspection Condition</b>	<b>Reference/Spec</b>
Operating Temperature	-40° to 85° C Ambient Environment	Individual Model Data Sheet
Storage Temperature	-40° to 85° C Ambient Environment	Individual Model Data Sheet
Barometric Pressure	100,000 Feet	MIL-STD-202, Method 105, Condition D
Humidity	90% RH, 65°C Units may require bake-out after humidity to restore full performance.	MIL-STD-202, Method 103
Thermal Shock	-65° to 125°C, 5 cycles	MIL-STD-202, Method 107, Condition B
Vibration (High Frequency)	20g peak, 10-2000 Hz, 12 times in each of three perpendicular directions (total 36)	MIL-STD-202, Method 204, Condition D
Mechanical Shock	100g, 6ms sawtooth, 3 shocks each direction 3 axes (total 18)	MIL-STD-202, Method 213, Condition I