

Coaxial

Diplexer

ZX75-23-S+

50Ω 9.8 to 2000 MHz
(9.8-10.2, 650-2000 MHz)



Generic photo used for illustration purposes only
CASE STYLE: FL905

The Big Deal

- Low insertion loss
- High Rejection
- Connectorized package

Product Overview

ZX75-23-S+ is a low-pass + high-pass combination device. Low pass port is designed for 9.8 to 10.2 MHz and high pass port is designed for 650 to 2000 MHz. This diplexer is used to pass IF, pilot carrier or clock synchronizing signal. This diplexer can also be used in various systems including satellite, CATV and multiband radio systems.

Key Features

Feature	Advantages
Low passband insertion loss	Suitable for high performance application.
Extended stopband rejection	Spurious rejection and avoids using additional filters.
Connectorized package	The connectorized package is easy to interface with other devices and well suited for test setups.

Notes

- A. Performance and quality attributes and conditions not expressly stated in this specification document are intended to be excluded and do not form a part of this specification document.
B. Electrical specifications and performance data contained in this specification document are based on Mini-Circuit's applicable established test performance criteria and measurement instructions.
C. The parts covered by this specification document are subject to Mini-Circuits standard limited warranty and terms and conditions (collectively, "Standard Terms"); Purchasers of this part are entitled to the rights and benefits contained therein. For a full statement of the Standard Terms and the exclusive rights and remedies thereunder, please visit Mini-Circuits' website at www.minicircuits.com/MCLStore/terms.jsp

Coaxial Diplexer

ZX75-23-S+

50Ω 9.8 to 2000 MHz (9.8-10.2, 650-2000 MHz)



Generic photo used for illustration purposes only

CASE STYLE: FL905

Connectors Model
SMA ZX75-23-S+

+RoHS Compliant

The +Suffix identifies RoHS Compliance. See our web site for RoHS Compliance methodologies and qualifications

Maximum Ratings

Operating Temperature	-40°C to 85°C
Storage Temperature	-55°C to 100°C
RF Power Input	400mW at 25°C

Permanent damage may occur if any of these limits are exceeded.

Pin Connections

HIGH PASS PORT	1
LOW PASS PORT	2
COMMON PORT	3

Features

- Low insertion loss
- 50Ω Impedance
- Combination of Low pass and High pass filters
- Connectorized package

Applications

- Clock synchronizing signal
- Satellite
- CATV

Outline Drawing

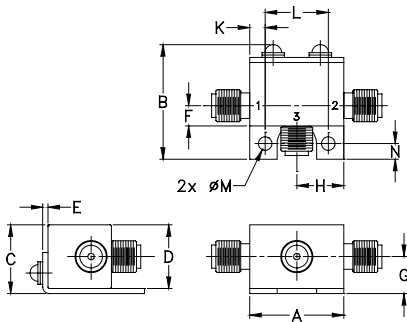

Outline Dimensions (inch/mm)

A	B	C	D	E	F	G
.74	.90	.54	.50	.04	.16	.29
18.80	22.86	13.72	12.70	1.02	4.06	7.37

H	J	K	L	M	N	wt
.37	--	.122	.496	.106	.122	grams
9.40	--	3.10	12.60	2.69	3.10	20.0

Note: Please refer to case style drawing for details

Electrical Specifications at 25°C

Parameter	Port	Frequency (MHz)	Min.	Typ.	Max.	Unit	
Pass Band	Insertion Loss	Low Pass	9.8-10.2	-	0.5	1.0	dB
		High Pass	650-2000	-	0.5	1.0	
	Return Loss	Low Pass	9.8-10.2	11	18	-	dB
		High Pass	650-2000	11	18	-	
Common		9.8-10.2	11	18	-		
Stop Band Isolation	Low Pass	50-2700	20	36	-	dB	
		650-2000	-	52	-		
	High Pass	DC-270	20	31	-	dB	
		9.8-10.2	-	90	-		

Typical Performance Data at 25°C

FREQUENCY (MHz)	INSERTION LOSS (dB)			RETURN LOSS (dB)	
	Low Pass Port	High Pass Port	Common Port	Low Pass Port	High Pass Port
0.5	0.34	93.34	28.34	28.42	0.00
9.8	0.48	93.68	19.95	19.16	0.00
10.2	0.49	95.02	20.18	19.38	0.00
20.0	1.17	98.30	14.16	15.32	0.00
30.0	11.08	92.74	1.20	1.84	0.00
40.0	25.01	90.28	0.39	0.78	0.00
50.0	36.55	86.20	0.25	0.51	0.00
150.0	55.68	59.20	0.06	0.09	0.03
270.0	57.07	31.52	0.09	0.05	0.13
350.0	57.55	18.64	0.22	0.04	0.32
400.0	58.29	11.80	0.57	0.04	0.71
450.0	60.23	6.09	1.76	0.04	1.96
480.0	62.23	3.57	3.40	0.04	3.63
500.0	63.69	2.37	5.05	0.04	5.31
650.0	62.66	0.31	24.49	0.04	26.69
750.0	61.76	0.29	18.54	0.04	19.44
1000.0	60.49	0.24	18.81	0.06	19.65
1250.0	59.18	0.20	21.26	0.07	22.03
1500.0	58.18	0.18	24.37	0.08	25.09
2000.0	55.65	0.24	29.14	0.11	29.69
2200.0	53.76	0.46	36.26	0.12	25.03
2700.0	52.48	0.23	21.59	0.31	21.42

Functional Schematic

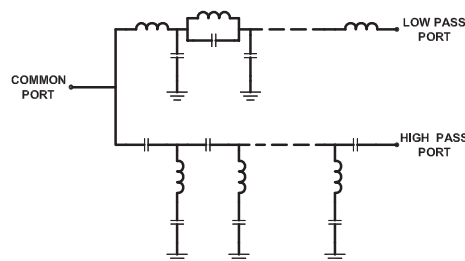

Notes

- Performance and quality attributes and conditions not expressly stated in this specification document are intended to be excluded and do not form a part of this specification document.
- Electrical specifications and performance data contained in this specification document are based on Mini-Circuits' applicable established test performance criteria and measurement instructions.
- The parts covered by this specification document are subject to Mini-Circuits standard limited warranty and terms and conditions (collectively, "Standard Terms"); Purchasers of this part are entitled to the rights and benefits contained therein. For a full statement of the Standard Terms and the exclusive rights and remedies thereunder, please visit Mini-Circuits' website at www.minicircuits.com/MCLStore/terms.jsp



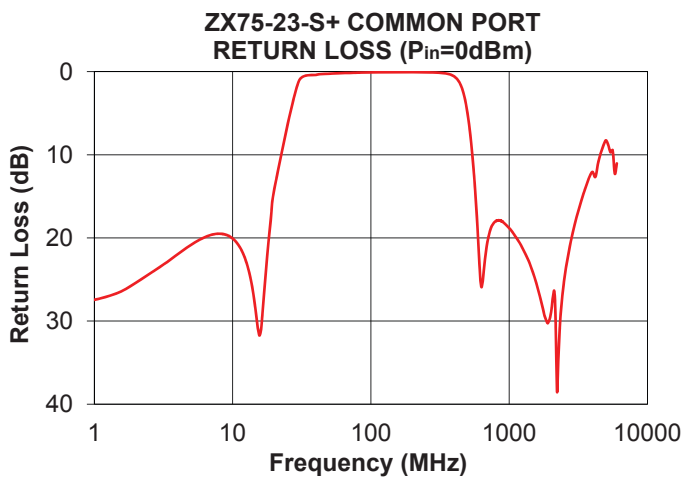
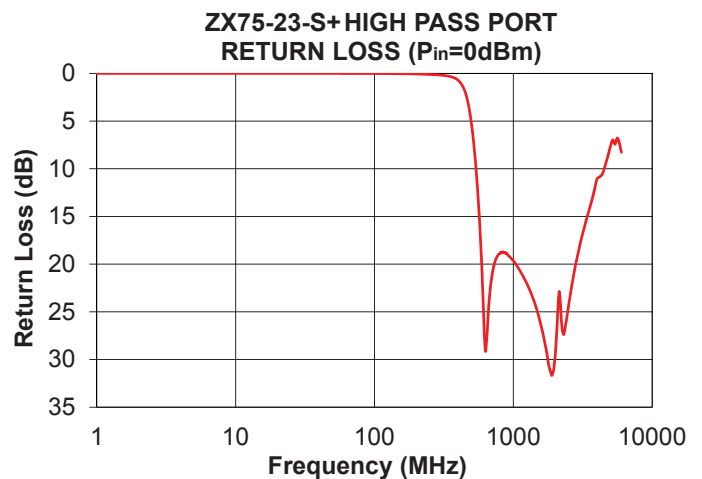
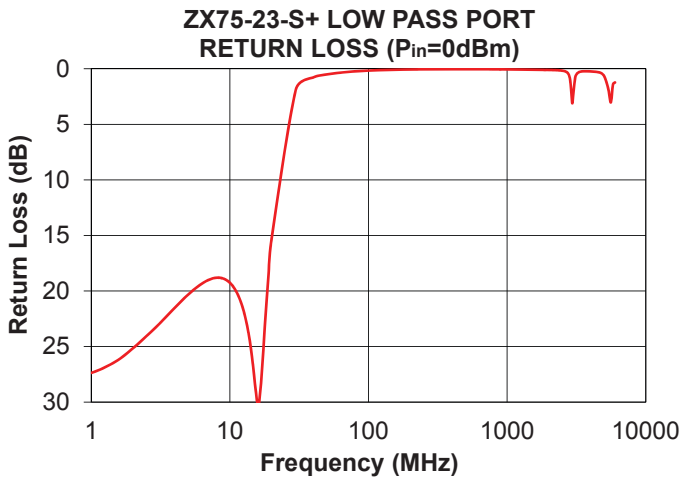
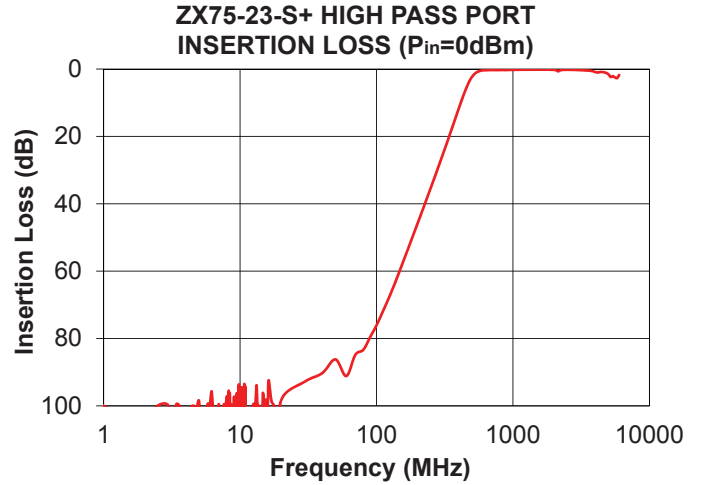
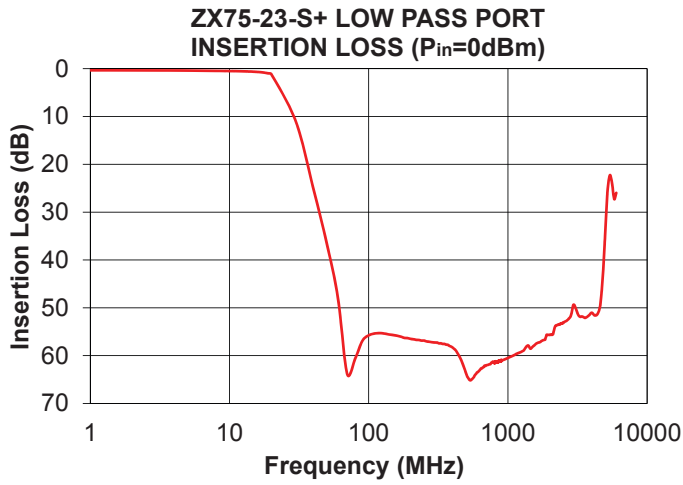

Notes

- A. Performance and quality attributes and conditions not expressly stated in this specification document are intended to be excluded and do not form a part of this specification document.
- B. Electrical specifications and performance data contained in this specification document are based on Mini-Circuit's applicable established test performance criteria and measurement instructions.
- C. The parts covered by this specification document are subject to Mini-Circuits standard limited warranty and terms and conditions (collectively, "Standard Terms"); Purchasers of this part are entitled to the rights and benefits contained therein. For a full statement of the Standard Terms and the exclusive rights and remedies thereunder, please visit Mini-Circuits' website at www.minicircuits.com/MCLStore/terms.jsp



Typical Performance Data

FREQUENCY (MHz)	INSERTION LOSS (dB)		Cross over isolation (dB) (Between LPF and HPF)	RETURN LOSS (dB)		
	Lowpass port	Highpass port		Common port	Lowpass port	Highpass port
0.50	0.34	93.34	104.01	28.34	28.42	0.00
1.00	0.34	99.99	101.48	27.45	27.38	0.00
5.00	0.39	98.58	97.54	20.84	20.32	0.00
8.00	0.45	97.22	103.71	19.49	18.80	0.00
9.00	0.47	99.43	97.73	19.63	18.89	0.00
9.80	0.48	93.68	111.03	19.95	19.16	0.00
9.85	0.49	108.32	106.03	19.99	19.19	0.00
9.90	0.49	104.94	105.36	20.01	19.21	0.00
9.95	0.49	104.37	101.41	20.04	19.22	0.00
10.00	0.49	97.32	102.84	20.08	19.26	0.00
10.05	0.49	96.76	104.20	20.09	19.28	0.00
10.10	0.49	100.97	99.51	20.12	19.31	0.00
10.15	0.49	100.58	104.45	20.17	19.34	0.00
10.20	0.49	95.02	104.59	20.18	19.38	0.00
11.00	0.51	101.47	104.82	20.83	19.94	0.00
12.00	0.53	103.78	111.99	22.01	20.99	0.00
13.00	0.56	98.60	101.61	23.75	22.50	0.00
14.00	0.59	112.49	102.52	26.34	24.67	0.00
15.00	0.63	99.21	105.82	30.06	27.74	0.00
16.00	0.68	98.56	126.01	31.22	30.32	0.00
20.00	1.17	98.30	103.14	14.16	15.32	0.00
30.00	11.08	92.74	95.17	1.20	1.84	0.00
40.00	25.01	90.28	98.85	0.39	0.78	0.00
50.00	36.55	86.20	99.42	0.25	0.51	0.00
100.00	55.75	76.08	116.07	0.09	0.16	0.01
150.00	55.68	59.20	96.30	0.06	0.09	0.03
200.00	56.49	45.85	89.56	0.06	0.06	0.06
250.00	56.85	35.23	93.61	0.08	0.05	0.11
260.00	57.02	33.34	91.26	0.08	0.05	0.12
270.00	57.07	31.52	88.69	0.09	0.05	0.13
300.00	57.27	26.37	90.05	0.11	0.05	0.18
350.00	57.55	18.64	81.35	0.22	0.04	0.32
400.00	58.29	11.80	74.71	0.57	0.04	0.71
450.00	60.23	6.09	69.15	1.76	0.04	1.96
480.00	62.23	3.57	66.77	3.40	0.04	3.63
500.00	63.69	2.37	65.35	5.05	0.04	5.31
550.00	64.96	0.82	63.97	11.34	0.04	11.72
600.00	63.51	0.39	63.33	21.12	0.04	22.22
650.00	62.66	0.31	62.89	24.49	0.04	26.69
700.00	62.01	0.30	62.67	20.27	0.04	21.31
800.00	61.34	0.28	61.97	17.98	0.05	18.87
900.00	61.04	0.26	61.01	18.07	0.05	18.94
1000.00	60.49	0.24	60.45	18.81	0.06	19.65
1250.00	59.18	0.20	58.97	21.26	0.07	22.03
1500.00	58.18	0.18	58.08	24.37	0.08	25.09
1750.00	56.91	0.17	56.89	28.46	0.09	29.48
2000.00	55.65	0.24	56.00	29.14	0.11	29.69
2100.00	55.56	0.49	56.22	26.45	0.11	24.36
2200.00	53.76	0.46	54.61	36.26	0.12	25.03
2300.00	53.53	0.26	54.34	32.09	0.13	27.36
2400.00	53.30	0.22	54.14	27.60	0.15	26.03
2500.00	53.16	0.22	54.02	24.98	0.17	24.35
2600.00	52.82	0.22	53.94	23.10	0.21	22.77
2700.00	52.48	0.23	53.86	21.59	0.31	21.42
2800.00	51.94	0.24	54.33	20.27	0.61	20.15
2900.00	50.38	0.26	57.75	19.15	1.97	19.08
3000.00	49.42	0.28	58.37	18.13	2.27	18.13
4000.00	51.03	0.87	53.42	12.06	0.23	11.10
5000.00	34.43	1.51	34.38	8.26	0.64	7.66
6000.00	25.98	1.78	29.93	11.04	1.23	8.26

Typical Performance Curves

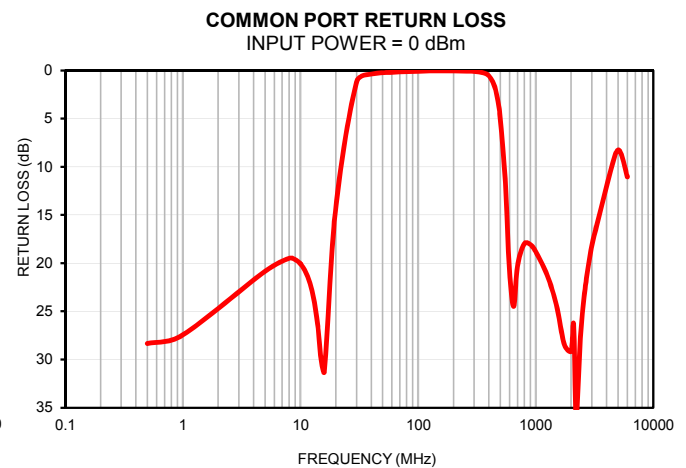
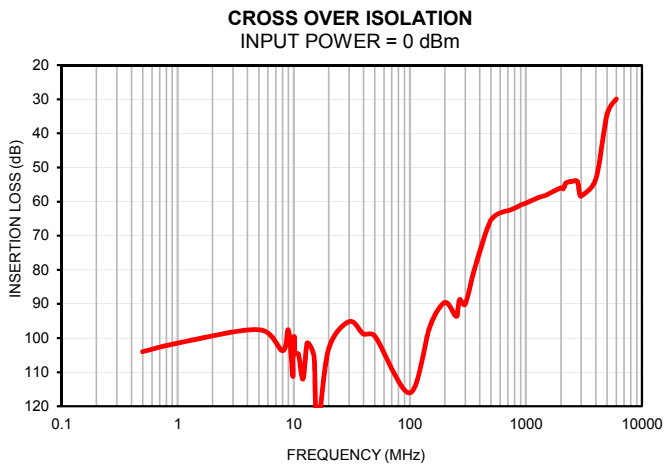
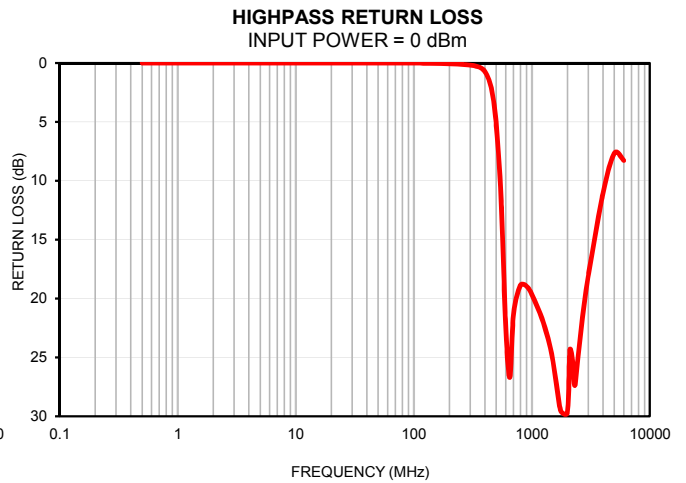
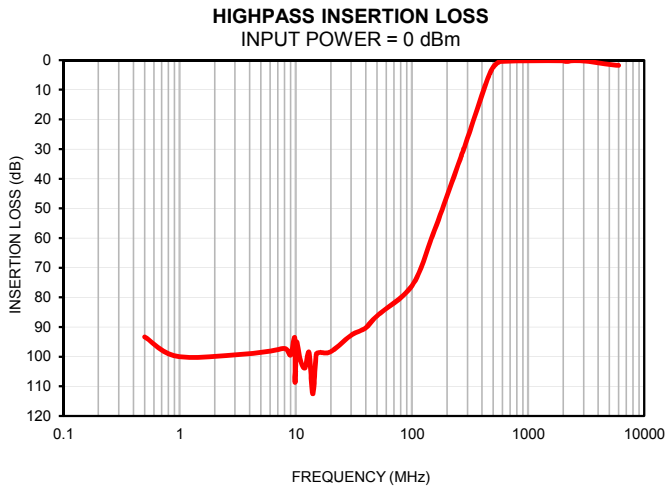
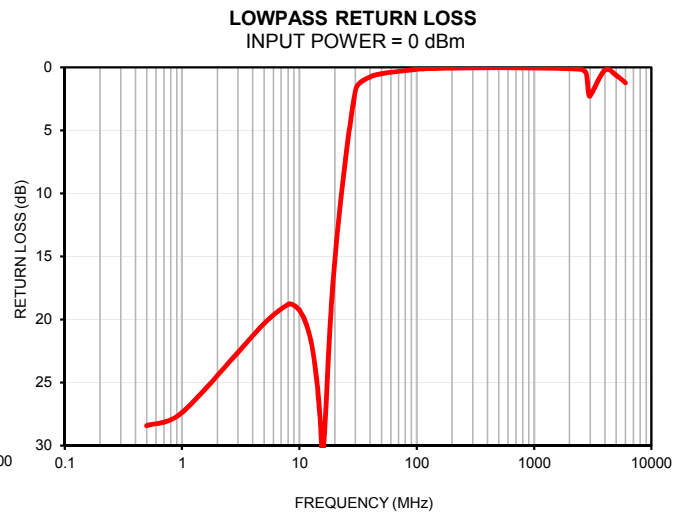
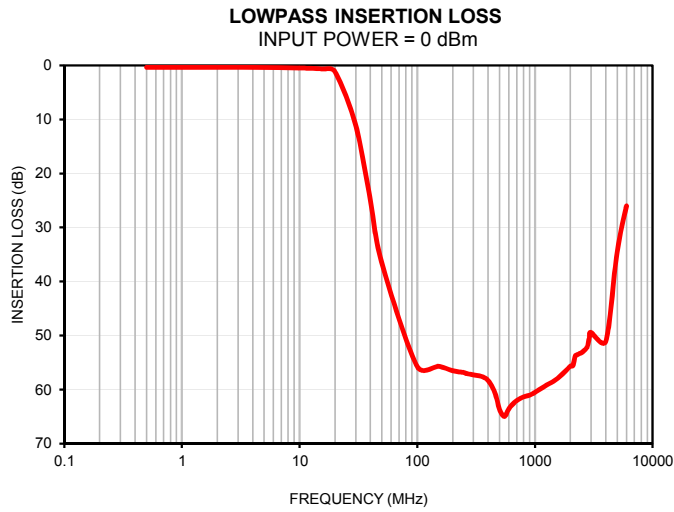

Outline Dimensions

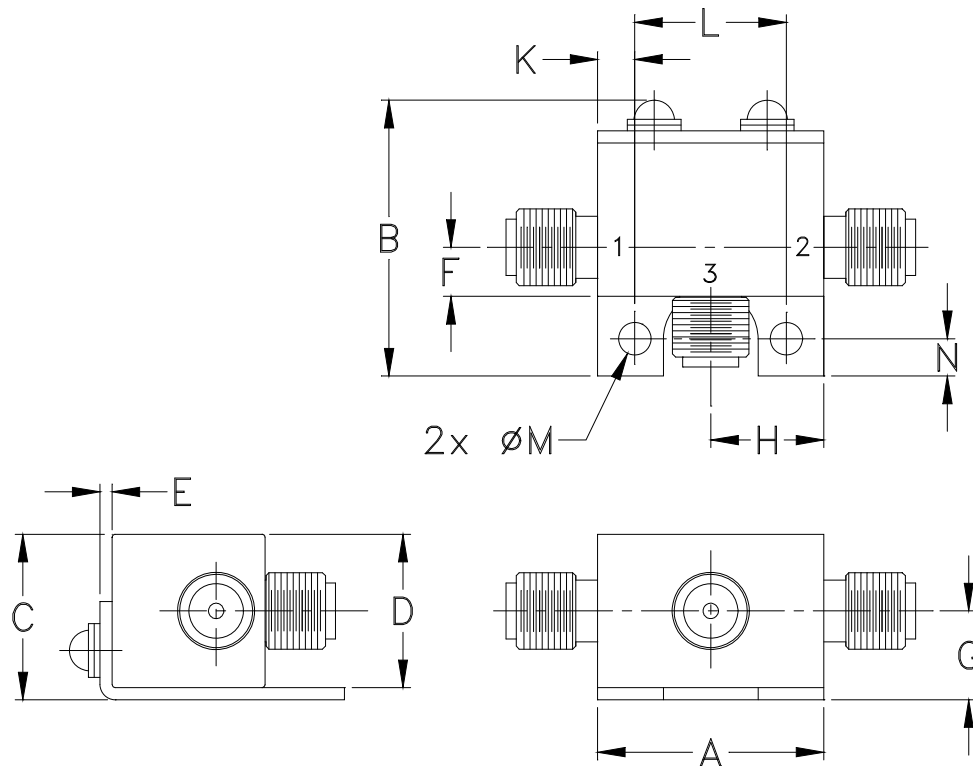

CASE #.	A	B	C	D	E	F	G	H	J	K	L	M	N	WT, GRAM
FL905	.74 (18.80)	.90 (22.86)	.54 (13.72)	.50 (12.70)	.04 (1.02)	.16 (4.06)	.29 (7.37)	.37 (9.40)	- -	.122 (3.10)	.496 (12.60)	.106 (2.69)	.122 (3.10)	20.0

Dimensions are in inches (mm). Tolerances: 2Pl. $\pm .03$; 3Pl. $\pm .015$.
Tolerance on hole size and interaxes dimensions to be $\pm .005$.

Notes:

1. Case material: Brass.
2. Case finish: Nickel plate.

Mini-Circuits®

INTERNET <http://www.minicircuits.com>

P.O. Box 350166, Brooklyn, New York 11235-0003 (718) 934-4500 Fax (718) 332-4661

Distribution Centers NORTH AMERICA 800-654-7949 • 417-335-5935 • Fax 417-335-5945 • EUROPE 44-1252-832600 • Fax 44-1252-837010

Mini-Circuits ISO 9001 & ISO 14001 Certified



All Mini-Circuits products are manufactured under exacting quality assurance and control standards, and are capable of meeting published specifications after being subjected to any or all of the following physical and environmental test.

Specification	Test/Inspection Condition	Reference/Spec
Operating Temperature	-40° to 85°C	Individual Model Data Sheet
Storage Temperature	-55° to 100° C Ambient Environment	Individual Model Data Sheet
Barometric Pressure	100,000 Feet	MIL-STD-202, Method 105, Condition D
Humidity	90% RH, 65°C Units may require bake-out after humidity to restore full performance.	MIL-STD-202, Method 103
Thermal Shock	-65° to 125°C, 5 cycles	MIL-STD-202, Method 107, Condition B
Vibration (High Frequency)	20g peak, 10-2000 Hz, 12 times in each of three perpendicular directions (total 36)	MIL-STD-202, Method 204, Condition D
Mechanical Shock	100g, 6ms sawtooth, 3 shocks each direction 3 axes (total 18)	MIL-STD-202, Method 213, Condition I