

# Power Detector

50Ω, -40dBm to +20dBm, 10 to 8000 MHz

## ZX47-40+ ZX47-40LN+



CASE STYLE: HN1173

Connectors	Model
SMA	ZX47-40-S+
SMA	ZX47-40LN-S+

**+RoHS Compliant**  
The +Suffix identifies RoHS Compliance. See our web site for RoHS Compliance methodologies and qualifications

### Maximum Ratings

Operating Temperature	-40°C to 85°C
Storage Temperature	-55°C to 100°C
DC Power:	
Max. voltage	5.7V
Max. current	120mA
Internal Power Dissipation	0.73W
Input Power	+27dBm

Permanent damage may occur if any of these limits are exceeded.

### Coaxial Connections

RF IN	1
DC OUT	5
Vcc (+5V)	2
TEMPERATURE SENSOR	4
GROUND	3

### Outline Drawing

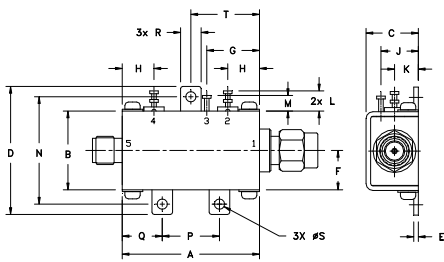

**NOTE:** When soldering the DC connections, caution must be used to avoid overheating the DC terminals. See Application Note [AN-40-10](#).

### Outline Dimensions (inch/mm)

A	B	C	D	E	F	G	H	J	K
1.20	.69	.46	1.12	.04	.34	.46	.28	.33	.21
30.48	17.53	11.68	28.45	1.02	8.64	11.68	7.11	8.38	5.33
L	M	N	P	Q	R	S	T	wt.	
.18	.14	.94	.50	.35	.18	.106	.60	grams	
4.57	3.56	23.88	12.70	8.89	4.57	2.69	15.24	31.8	

### Simplified Functional Diagram

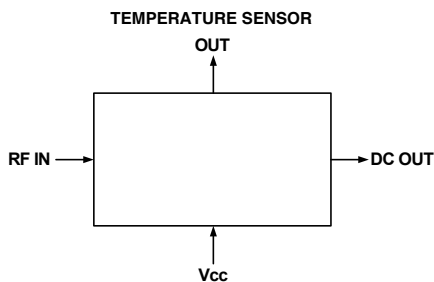

### Features

- Low Noise (Output Ripple) for ZX47-40LN+, 20mVp-p Typ. @ 10MHz
- High Dynamic Range
- Wide Bandwidth
- Single Supply Voltage: +5V
- Stability Over Temperature
- Built-in Temperature Sensor
- Protected by US patent 6,790,049

### Applications

- RF/IF Power Measurements
- Low Cost Power Monitoring System
- RF Leakage Monitors
- Fast feedback Levelling Circuits
- RF Power Control
- Receiver RF/IF Gain Control
- RSSI measurements

### Electrical Specifications (T<sub>AMB</sub> = 25°C)

FREQ. (MHz)	DYNAMIC RANGE AT ±1dB ERROR (dBm)	OUTPUT VOLT. RANGE (V)	SLOPE (mV/dB) (Note 1)	VSWR (:1)	PULSE RESPONSE TIME (nSec)		TEMP. SENSOR OUTPUT SLOPE (mV/°C) (Note 2)	DC OPERATING POWER						
					Typ.			Vcc (Volts)		Note 3 Current (mA)				
Min.	Max.	Typ.	Typ.	Typ.	Typ.	ZX47-40+ Rise	ZX47-40LN+ Fall	Typ.	Min.	Typ.	Max.	Typ.		
10	1000	-40 to +20			1.03									
1000	5000	-40 to +15	0.50 - 2.10	-25	1.10	400	10	800	400	2.00	4.5	5.0	5.5	100
5000	6000	-35 to +20			1.20									
6000	8000	-30 to +20			1.40									

Notes:

1. The negative slope indicates that Output Voltage decreases as Input Power increases. See "Output Voltage vs Input Power" graph below.
2. Temperature sensor output provides a DC Output Voltage which increases linearly with temperature rise. Recommended minimum load for this port is 2 kΩ.
3. Recommended minimum load at DC out port is 100 Ω. See maximum ratings for no damage.

### Output Voltage Vs Input Power @ +25°C

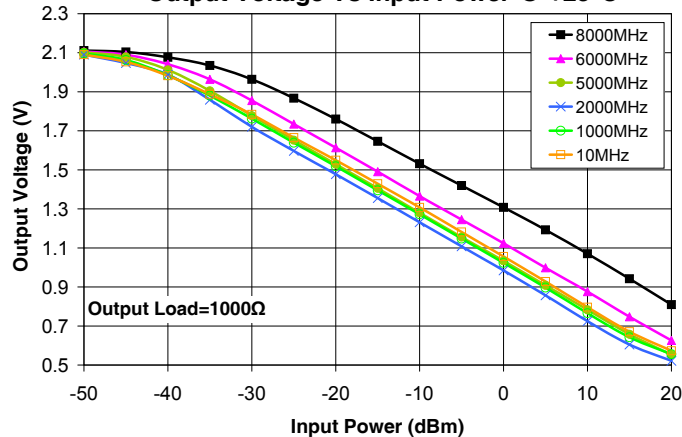

### Notes

- A. Performance and quality attributes and conditions not expressly stated in this specification document are intended to be excluded and do not form a part of this specification document.
- B. Electrical specifications and performance data contained in this specification document are based on Mini-Circuit's applicable established test performance criteria and measurement instructions.
- C. The parts covered by this specification document are subject to Mini-Circuits standard limited warranty and terms and conditions (collectively, "Standard Terms"); Purchasers of this part are entitled to the rights and benefits contained therein. For a full statement of the Standard Terms and the exclusive rights and remedies thereunder, please visit Mini-Circuits' website at [www.minicircuits.com/MCLStore/terms.jsp](http://www.minicircuits.com/MCLStore/terms.jsp)



## Performance Curves

**Power Input Deviation from Ideal Vs Output Voltage @ Freq 10MHz**

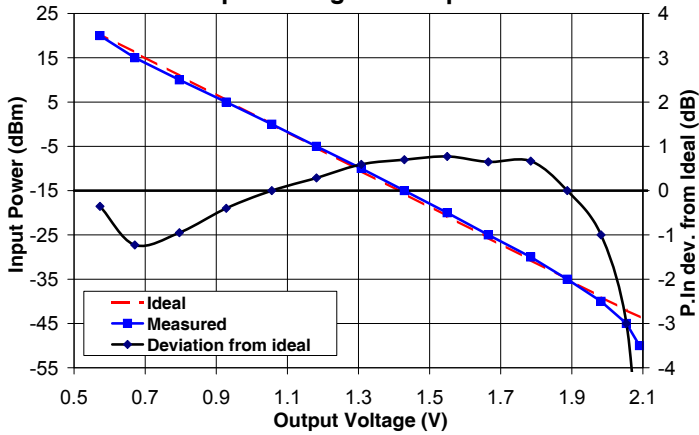

**Power Input Deviation from Ideal Vs Output Voltage @ Freq 2000MHz**

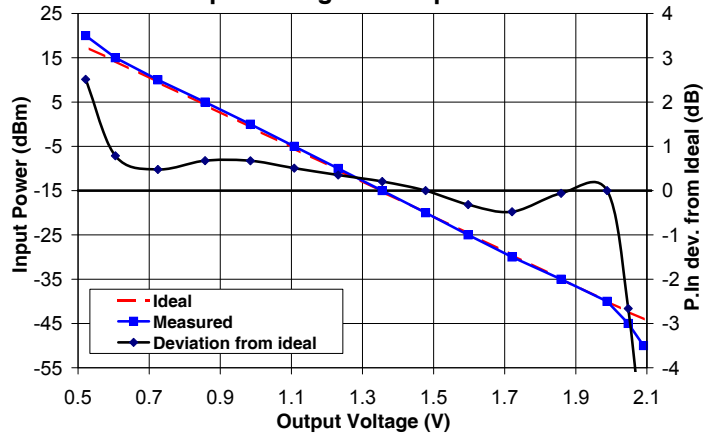

**Power Input Deviation from Ideal Vs Output Voltage @ Freq 6000MHz**

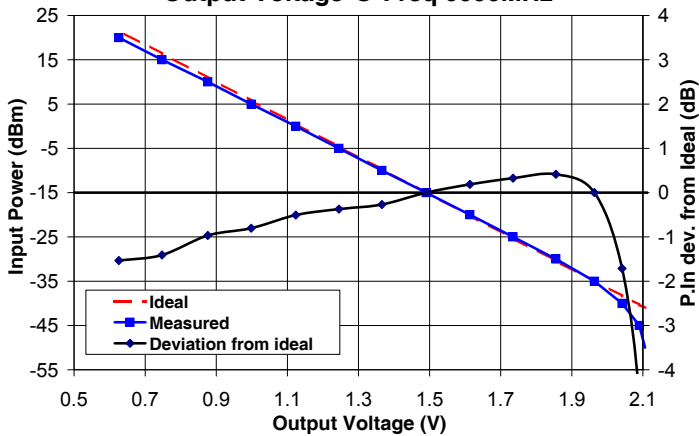

**Power Input Deviation from Ideal Vs Output Voltage @ Freq 8000MHz**

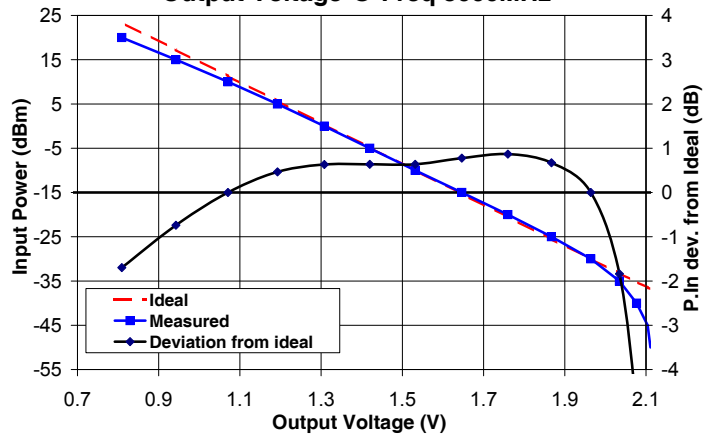

**Output Voltage Change Vs Freq Over Temperature Range**

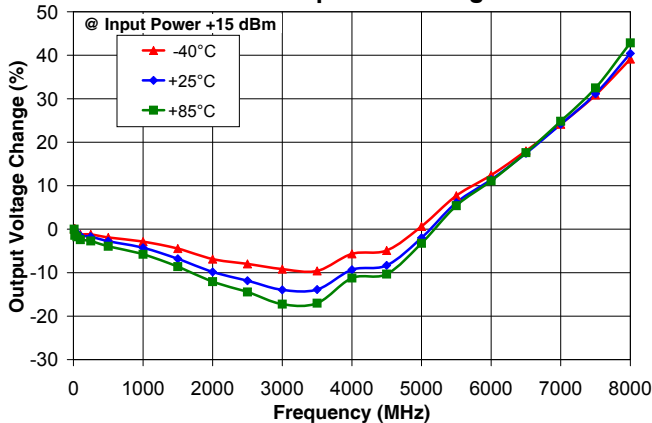

**Output Voltage Change Vs Freq Over Temperature Range**

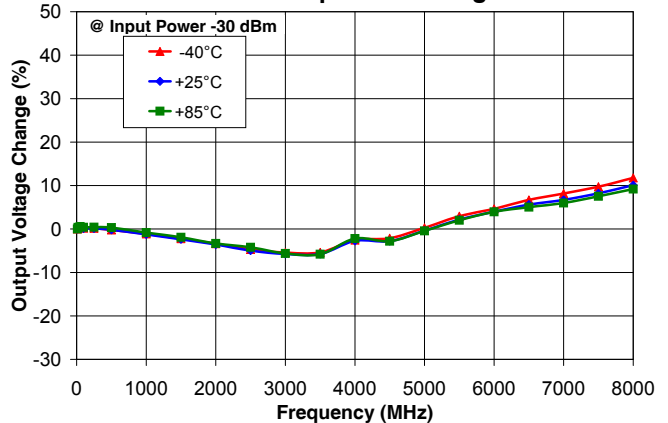

**Notes**

- A. Performance and quality attributes and conditions not expressly stated in this specification document are intended to be excluded and do not form a part of this specification document.
- B. Electrical specifications and performance data contained in this specification document are based on Mini-Circuit's applicable established test performance criteria and measurement instructions.
- C. The parts covered by this specification document are subject to Mini-Circuits standard limited warranty and terms and conditions (collectively, "Standard Terms"); Purchasers of this part are entitled to the rights and benefits contained therein. For a full statement of the Standard Terms and the exclusive rights and remedies thereunder, please visit Mini-Circuits' website at [www.minicircuits.com/MCLStore/terms.jsp](http://www.minicircuits.com/MCLStore/terms.jsp)



# Performance Curves

# ZX47-40+ ZX47-40LN+

**Slope Vs Input Power Over Temperature Range @ Freq 10MHz**

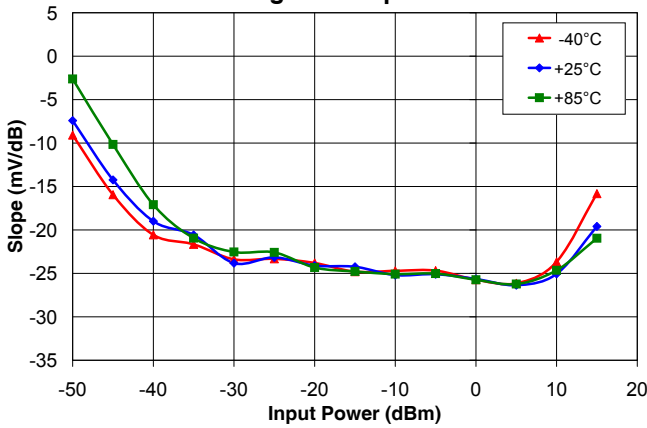

**Slope Vs Freq Over Temperature Range @ Input Power -40dBm**

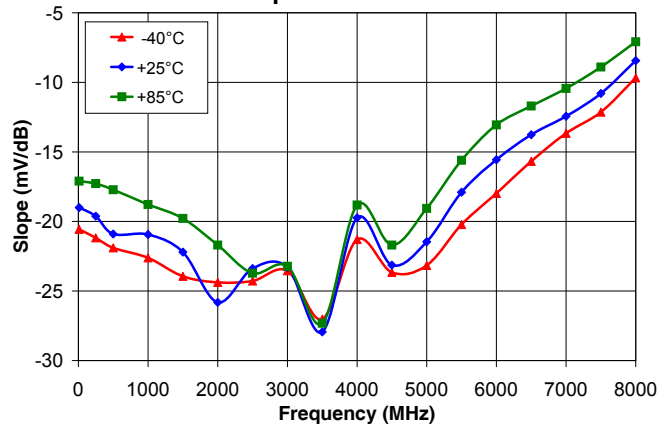

**Slope Vs Input Power Over Temperature Range @ Freq 5000MHz**

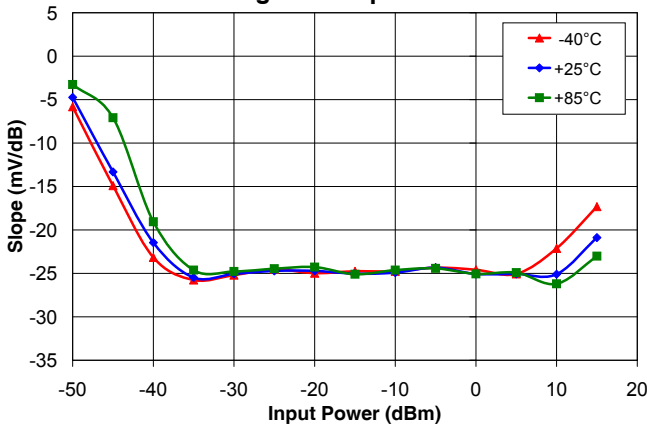

**Slope Vs Freq Over Temperature Range @ Input Power -25dBm**

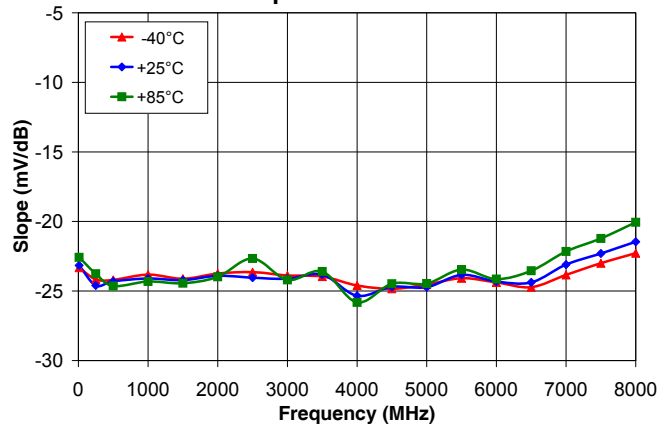

**Slope Vs Input Power Over Temperature Range @ Freq 8000MHz**

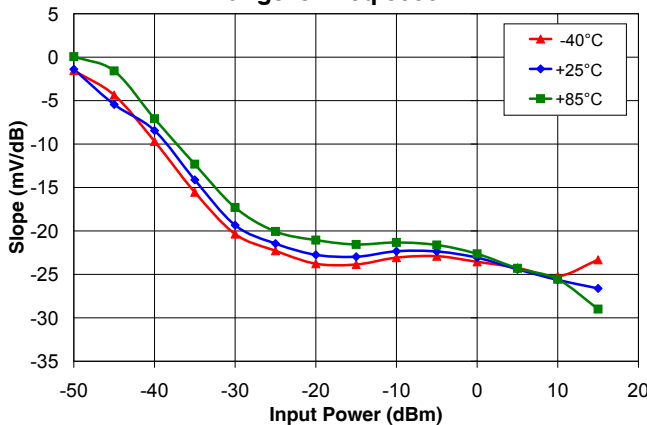

**Slope Vs Freq Over Temperature Range @ Input Power 0dBm**

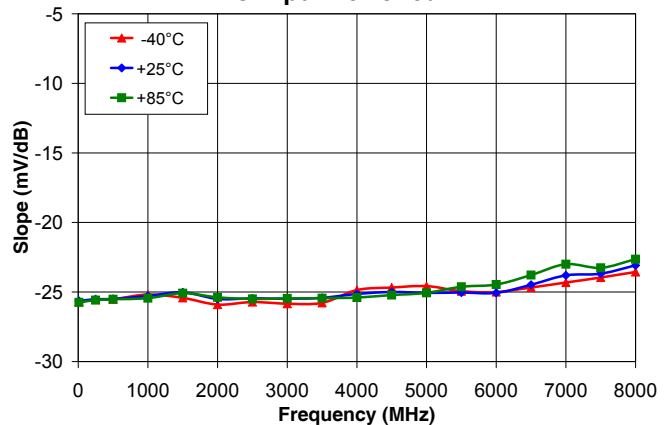

**Notes**

- A. Performance and quality attributes and conditions not expressly stated in this specification document are intended to be excluded and do not form a part of this specification document.
- B. Electrical specifications and performance data contained in this specification document are based on Mini-Circuits' applicable established test performance criteria and measurement instructions.
- C. The parts covered by this specification document are subject to Mini-Circuits standard limited warranty and terms and conditions (collectively, "Standard Terms"); Purchasers of this part are entitled to the rights and benefits contained therein. For a full statement of the Standard Terms and the exclusive rights and remedies thereunder, please visit Mini-Circuits' website at [www.minicircuits.com/MCLStore/terms.jsp](http://www.minicircuits.com/MCLStore/terms.jsp)



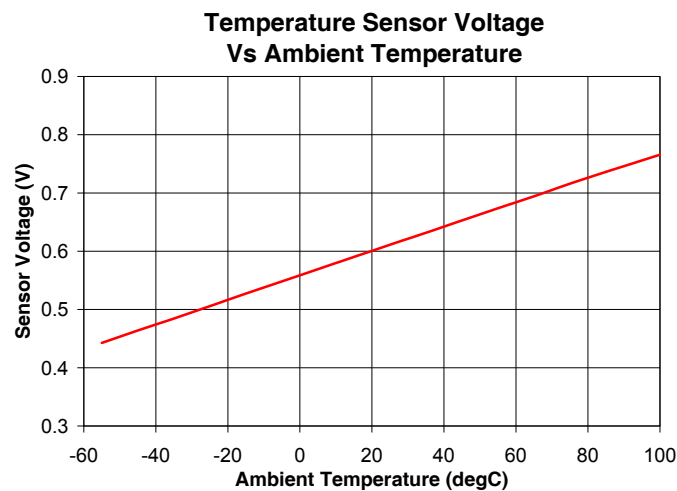
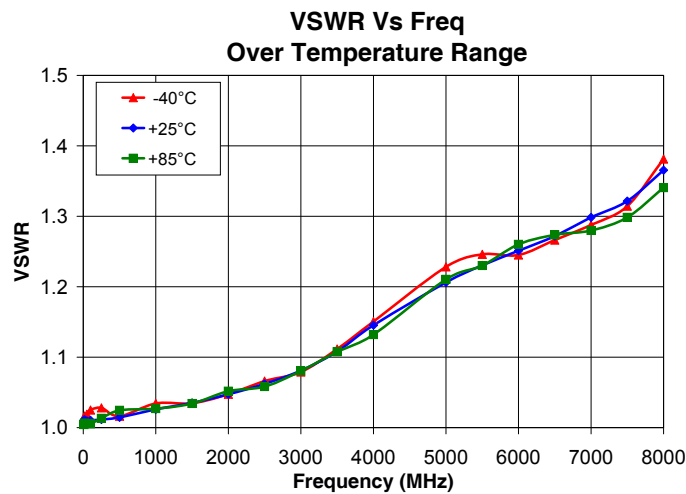
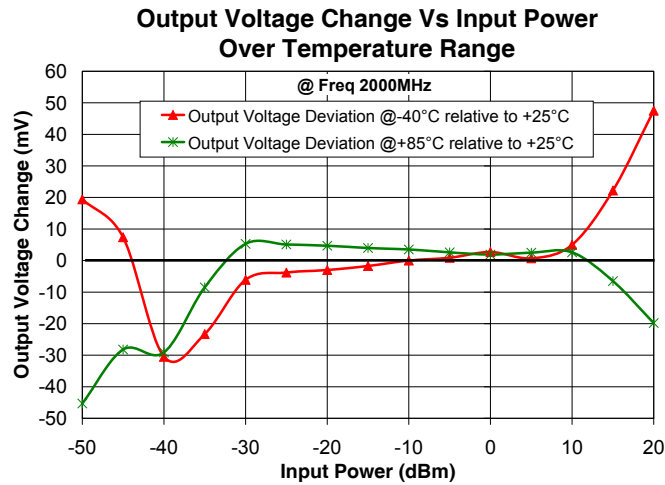

**Notes**

- A. Performance and quality attributes and conditions not expressly stated in this specification document are intended to be excluded and do not form a part of this specification document.
- B. Electrical specifications and performance data contained in this specification document are based on Mini-Circuit's applicable established test performance criteria and measurement instructions.
- C. The parts covered by this specification document are subject to Mini-Circuits standard limited warranty and terms and conditions (collectively, "Standard Terms"); Purchasers of this part are entitled to the rights and benefits contained therein. For a full statement of the Standard Terms and the exclusive rights and remedies thereunder, please visit Mini-Circuits' website at [www.minicircuits.com/MCLStore/terms.jsp](http://www.minicircuits.com/MCLStore/terms.jsp)



# Power Detector

# ZX47-40LN+

## Typical Performance Data

Output Voltage vs. Input Power @+25°C						
POWER IN (dBm)	@10MHz (V)	@1000MHz (V)	@2000MHz (V)	@5000MHz (V)	@6000MHz (V)	@8000MHz (V)
-50	2.09	2.10	2.09	2.10	2.11	2.11
-45	2.05	2.06	2.05	2.08	2.09	2.10
-40	1.98	1.98	1.99	2.01	2.04	2.08
-35	1.89	1.88	1.86	1.91	1.96	2.03
-30	1.78	1.76	1.72	1.78	1.86	1.96
-25	1.67	1.64	1.60	1.65	1.73	1.87
-20	1.55	1.52	1.48	1.53	1.61	1.76
-15	1.43	1.40	1.36	1.41	1.49	1.65
-10	1.31	1.27	1.23	1.28	1.37	1.53
-5	1.18	1.15	1.11	1.16	1.25	1.42
0	1.06	1.02	0.98	1.03	1.12	1.31
5	0.93	0.90	0.86	0.91	1.00	1.19
10	0.80	0.77	0.72	0.78	0.88	1.07
15	0.67	0.64	0.60	0.66	0.75	0.94
20	0.57	0.56	0.52	0.55	0.63	0.81

Output Voltage Change Vs Freq						
FREQ (MHz)	@ Input Power -30 dBm			@ Input Power +15dBm		
	-40°C	+25°C	+85°C	-40°C	+25°C	+85°C
10	0.00	0.00	0.00	0.00	0.00	0.00
20	0.20	0.08	0.37	0.18	-0.34	-1.41
50	0.36	0.29	0.57	-0.71	-0.94	-1.76
100	0.20	0.12	0.40	-1.19	-1.52	-2.42
250	0.18	0.13	0.42	-1.20	-1.73	-2.72
500	-0.20	-0.18	0.32	-1.92	-2.77	-3.94
1000	-1.13	-1.24	-0.82	-2.85	-4.29	-5.77
1500	-2.23	-2.36	-1.91	-4.44	-6.81	-8.61
2000	-3.38	-3.58	-3.32	-6.88	-9.85	-12.08
2500	-4.71	-4.96	-4.21	-7.99	-11.85	-14.44
3000	-5.42	-5.74	-5.62	-9.18	-13.95	-17.23
3500	-5.39	-5.76	-5.80	-9.61	-13.89	-17.03
4000	-2.55	-2.74	-2.20	-5.67	-9.31	-11.23
4500	-2.13	-2.79	-2.81	-4.90	-8.33	-10.33
5000	0.28	-0.38	-0.43	0.64	-2.00	-3.26
5500	2.94	2.15	2.01	7.69	6.10	5.41
6000	4.64	3.97	3.95	12.43	11.39	11.11
6500	6.69	5.62	5.02	18.00	17.45	17.60
7000	8.17	6.70	5.99	24.13	24.13	24.83
7500	9.74	8.20	7.52	30.86	31.13	32.49
8000	11.77	10.07	9.20	39.13	40.43	42.86



For detailed performance specs & shopping online see web site

P.O. Box 350166, Brooklyn, New York 11235-0003 (718) 934-4500 Fax (718) 332-4661 The Design Engineers Search Engine Provides ACTUAL Data Instantly at [minicircuits.com](http://minicircuits.com)

IF/RF MICROWAVE COMPONENTS

Notes: 1. Performance and quality attributes and conditions not expressly stated in this specification sheet are intended to be excluded and do not form a part of this specification sheet. 2. Electrical specifications and performance data contained herein are based on Mini-Circuit's applicable established test performance criteria and measurement instructions. 3. The parts covered by this specification sheet are subject to Mini-Circuit's standard limited warranty and terms and conditions (collectively, "Standard Terms"); Purchase of this part are entitled to the rights and benefits contained therein. For a full statement of the Standard Terms and the exclusive rights and remedies thereunder, please visit Mini-Circuit's website at [www.minicircuits.com/MC/Store/terms.jsp](http://www.minicircuits.com/MC/Store/terms.jsp).

# Power Detector

# ZX47-40LN+

## Typical Performance Data

Sensitivity vs. Input Power @+25°C						
Measured	@10MHz(mV/dB)			@2000MHz(mV/dB)		
	Output Voltage (V)	Ideal	Deviation from idea	Output Voltage (V)	Ideal	Deviation from idea
-50	2.09	-43.56	-6.44	2.09	-44.03	-5.97
-45	2.05	-42.00	-3.00	2.05	-42.34	-2.66
-40	1.98	-39.00	-1.00	1.99	-40.00	0.00
-35	1.89	-35.00	0.00	1.86	-34.94	-0.06
-30	1.78	-30.67	0.67	1.72	-29.52	-0.48
-25	1.67	-25.65	0.65	1.60	-24.68	-0.32
-20	1.55	-20.77	0.77	1.48	-20.00	0.00
-15	1.43	-15.70	0.70	1.36	-15.21	0.21
-10	1.31	-10.59	0.59	1.23	-10.35	0.35
-5	1.18	-5.29	0.29	1.11	-5.51	0.51
0	1.06	0.00	0.00	0.98	-0.67	0.67
5	0.93	5.40	-0.40	0.86	4.32	0.68
10	0.80	10.95	-0.95	0.72	9.52	0.48
15	0.67	16.23	-1.23	0.60	14.21	0.79
20	0.57	20.36	-0.36	0.52	17.49	2.51

Sensitivity vs. Input Power @+25°C						
Measured	@6000MHz(mV/dB)			@8000MHz(mV/dB)		
	Output Voltage (V)	Ideal	Deviation from idea	Output Voltage (V)	Ideal	Deviation from idea
-50	2.11	-41.01	-8.99	2.11	-36.79	-13.42
-45	2.09	-40.34	-4.66	2.10	-36.47	-8.73
-40	2.04	-38.29	-1.71	2.08	-35.22	-4.95
-35	1.96	-35.00	0.00	2.03	-33.26	-1.84
-30	1.86	-30.41	0.41	1.96	-30.00	0.00
-25	1.73	-25.33	0.33	1.87	-25.53	0.67
-20	1.61	-20.19	0.19	1.76	-20.57	0.87
-15	1.49	-15.00	0.00	1.65	-15.31	0.78
-10	1.37	-9.73	-0.27	1.53	-10.00	0.64
-5	1.25	-4.63	-0.37	1.42	-4.83	0.64
0	1.12	0.51	-0.51	1.31	0.34	0.63
5	1.00	5.80	-0.80	1.19	5.67	0.47
10	0.88	10.97	-0.97	1.07	11.32	0.00
15	0.75	16.41	-1.41	0.94	17.25	-0.74
20	0.63	21.53	-1.53	0.81	23.40	-1.70



For detailed performance specs & shopping online see web site

P.O. Box 350166, Brooklyn, New York 11235-0003 (718) 934-4500 Fax (718) 332-4666 The Design Engineers Search Engine Provides ACTUAL Data Instantly at [minicircuits.com](http://minicircuits.com)

IF/RF MICROWAVE COMPONENTS

Notes: 1. Performance and quality attributes and conditions not expressly stated in this specification sheet are intended to be excluded and do not form a part of this specification sheet. 2. Electrical specifications and performance data contained herein are based on Mini-Circuit's applicable established test performance criteria and measurement instructions. 3. The parts covered by this specification sheet are subject to Mini-Circuit's standard limited warranty and terms and conditions (collectively, "Standard Terms"); Purchasers of this part are entitled to the rights and benefits contained therein. For a full statement of the Standard Terms and the exclusive rights and remedies thereunder, please visit Mini-Circuit's website at [www.minicircuits.com/MCStore/terms.jsp](http://www.minicircuits.com/MCStore/terms.jsp).

# Power Detector

# ZX47-40LN+

## Typical Performance Data

POWER IN (dBm)	Slope Vs Input Power Over Temperature								
	Range @ Freq 10MHz			Range @ Freq 5000MHz			Range @ Freq 8000MHz		
	-40°C	+25°C	+85°C	-40°C	+25°C	+85°C	-40°C	+25°C	+85°C
-50	-9.08	-7.42	-2.62	-5.82	-4.74	-3.26	-1.54	-1.38	0.06
-45	-15.94	-14.24	-10.16	-14.90	-13.32	-7.08	-4.36	-5.44	-1.58
-40	-20.56	-19.00	-17.10	-23.16	-21.46	-19.06	-9.68	-8.44	-7.08
-35	-21.66	-20.58	-20.94	-25.76	-25.48	-24.62	-15.54	-14.12	-12.32
-30	-23.38	-23.82	-22.54	-25.20	-25.06	-24.78	-20.36	-19.34	-17.30
-25	-23.32	-23.16	-22.58	-24.54	-24.72	-24.46	-22.28	-21.46	-20.06
-20	-23.80	-24.10	-24.32	-24.98	-24.70	-24.28	-23.78	-22.74	-21.06
-15	-24.80	-24.24	-24.78	-24.76	-25.04	-25.10	-23.86	-22.96	-21.56
-10	-24.70	-25.20	-25.08	-24.76	-24.92	-24.62	-23.08	-22.34	-21.32
-5	-24.68	-25.10	-25.02	-24.34	-24.34	-24.42	-22.90	-22.36	-21.62
0	-25.72	-25.64	-25.74	-24.58	-25.06	-25.06	-23.56	-23.08	-22.64
5	-26.14	-26.36	-26.22	-25.06	-25.06	-24.92	-24.24	-24.42	-24.30
10	-23.68	-25.06	-24.64	-22.12	-25.10	-26.20	-25.22	-25.64	-25.56
15	-15.82	-19.60	-20.96	-17.32	-20.88	-23.02	-23.32	-26.62	-29.00

FREQ (MHz)	Slope Vs Freq Over Temperature Range								
	@ Input Power -40dBm			@ Input Power -25dBm			@ Input Power 0dBm		
	-40°C	+25°C	+85°C	-40°C	+25°C	+85°C	-40°C	+25°C	+85°C
10	-20.56	-19.00	-17.10	-23.32	-23.16	-22.58	-25.72	-25.64	-25.74
250	-21.18	-19.62	-17.28	-24.16	-24.60	-23.76	-25.54	-25.52	-25.58
500	-21.90	-20.90	-17.72	-24.20	-24.30	-24.64	-25.52	-25.50	-25.52
1000	-22.62	-20.94	-18.78	-23.82	-24.10	-24.32	-25.18	-25.28	-25.44
1500	-23.94	-22.20	-19.78	-24.12	-24.22	-24.44	-25.42	-25.02	-25.08
2000	-24.38	-25.82	-21.70	-23.74	-23.90	-23.98	-25.90	-25.50	-25.38
2500	-24.28	-23.38	-23.72	-23.64	-24.04	-22.66	-25.72	-25.46	-25.50
3000	-23.54	-23.30	-23.22	-23.88	-24.12	-24.20	-25.84	-25.48	-25.46
3500	-27.02	-27.94	-27.32	-23.96	-23.82	-23.60	-25.78	-25.42	-25.44
4000	-21.30	-19.74	-18.82	-24.60	-25.34	-25.82	-24.86	-25.14	-25.40
4500	-23.66	-23.14	-21.70	-24.84	-24.70	-24.48	-24.68	-25.00	-25.22
5000	-23.16	-21.46	-19.06	-24.54	-24.72	-24.46	-24.58	-25.06	-25.06
5500	-20.22	-17.90	-15.60	-24.08	-23.84	-23.46	-24.94	-25.04	-24.62
6000	-17.98	-15.56	-13.06	-24.38	-24.32	-24.14	-25.00	-25.06	-24.46
6500	-15.68	-13.76	-11.70	-24.72	-24.38	-23.54	-24.68	-24.48	-23.78
7000	-13.66	-12.44	-10.44	-23.84	-23.10	-22.16	-24.32	-23.80	-23.00
7500	-12.14	-10.80	-8.90	-23.00	-22.30	-21.22	-23.96	-23.68	-23.26
8000	-9.68	-8.44	-7.08	-22.28	-21.46	-20.06	-23.56	-23.08	-22.64



For detailed performance specs & shopping online see web site

P.O. Box 350166, Brooklyn, New York 11235-0003 (718) 934-4500 Fax (718) 332-4661 The Design Engineers Search Engine Provides ACTUAL Data Instantly at [minicircuits.com](http://minicircuits.com)

IF/RF MICROWAVE COMPONENTS

Notes: 1. Performance and quality attributes and conditions not expressly stated in this specification sheet are intended to be excluded and do not form a part of this specification sheet. 2. Electrical specifications and performance data contained herein are based on Mini-Circuit's applicable established test performance criteria and measurement instructions. 3. The parts covered by this specification sheet are subject to Mini-Circuit's standard limited warranty and terms and conditions (collectively, "Standard Terms"); Purchases of this part are entitled to the rights and benefits contained therein. For a full statement of the Standard Terms and the exclusive rights and remedies thereunder, please visit Mini-Circuit's website at [www.minicircuits.com/MCIStore/terms.jsp](http://www.minicircuits.com/MCIStore/terms.jsp).

# Power Detector

# ZX47-40LN+

## Typical Performance Data

Output Voltage Change Vs Input Power		
POWER IN (dBm)	Output Voltage Deviation @-40°C relative to +25°C	Output Voltage Deviation @+85°C relative to +25°C
-50	19.40	-45.30
-45	7.40	-28.20
-40	-30.50	-29.10
-35	-23.30	-8.50
-30	-6.10	5.30
-25	-3.80	5.10
-20	-3.00	4.70
-15	-1.70	4.00
-10	0.00	3.50
-5	0.90	2.60
0	2.70	1.90
5	0.70	2.50
10	5.00	2.60
15	22.20	-6.50
20	47.50	-19.80

VSWR Vs Freq			
FREQ (MHz)	-40dBm	+25dBm	+85dBm
10	1.01	1.01	1.00
20	1.02	1.01	1.01
50	1.02	1.01	1.01
100	1.03	1.01	1.01
250	1.03	1.01	1.01
500	1.02	1.01	1.02
1000	1.03	1.03	1.03
1500	1.04	1.04	1.03
2000	1.05	1.05	1.05
2500	1.07	1.06	1.06
3000	1.08	1.08	1.08
3500	1.11	1.11	1.11
4000	1.15	1.15	1.13
5000	1.23	1.21	1.21
5500	1.25	1.23	1.23
6000	1.25	1.25	1.26
6500	1.27	1.27	1.27
7000	1.29	1.30	1.28
7500	1.31	1.32	1.30
8000	1.38	1.37	1.34

Temperature Sensor Voltage Vs Ambient	
Temp (°C)	Voltage @ 8000MHz
-55	0.44
-45	0.46
-35	0.48
-25	0.51
-15	0.53
0	0.56
10	0.58
20	0.60
27	0.62
35	0.63
45	0.65
55	0.67
65	0.69
75	0.72
85	0.74
100	0.77



P.O. Box 350166, Brooklyn, New York 11235-0003 (718) 934-4500 Fax (718) 332-4661 *The Design Engineers Search Engine* Provides ACTUAL Data Instantly at [minicircuits.com](http://minicircuits.com)

For detailed performance specs & shopping online see web site

ISO 9001 ISO 14001 AS 9100 CERTIFIED  
RF/MICROWAVE COMPONENTS

Notes: 1. Performance and quality attributes and conditions not expressly stated in this specification sheet are intended to be excluded and do not form a part of this specification sheet. 2. Electrical specifications and performance data contained herein are based on Mini-Circuit's applicable established test performance criteria and measurement instructions. 3. The parts covered by this specification sheet are subject to Mini-Circuit's standard limited warranty and terms and conditions (collectively, "Standard Terms"); Purchase of this part are entitled to the rights and benefits contained therein. For a full statement of the Standard Terms and the exclusive rights and remedies thereunder, please visit Mini-Circuit's website at [www.minicircuits.com/MCStore/terms.jsp](http://www.minicircuits.com/MCStore/terms.jsp).



# Power Detector

# ZX47-40LN+

## Typical Performance Curves

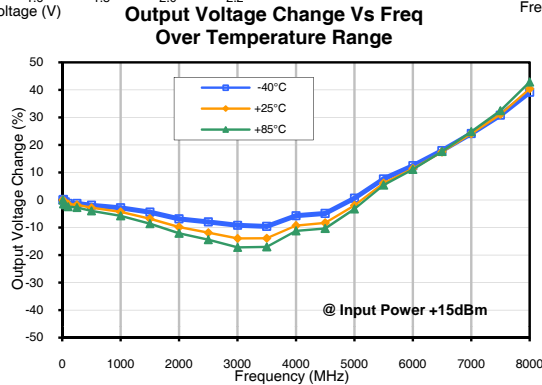
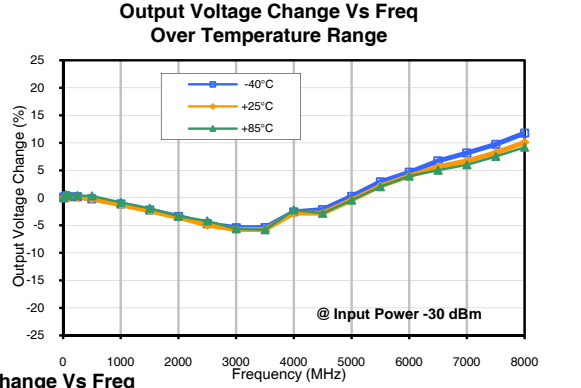
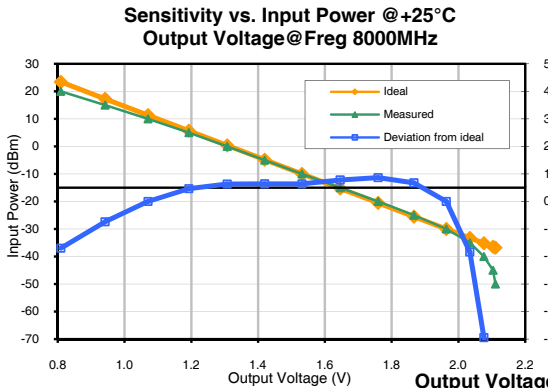
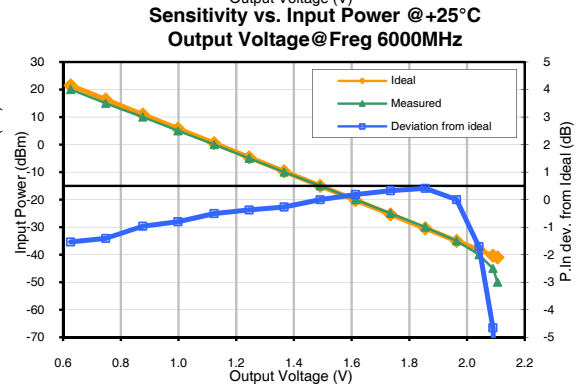
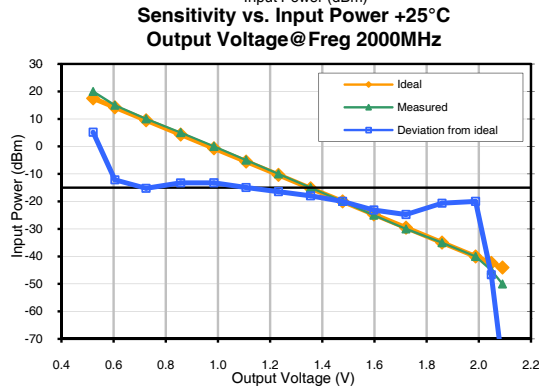
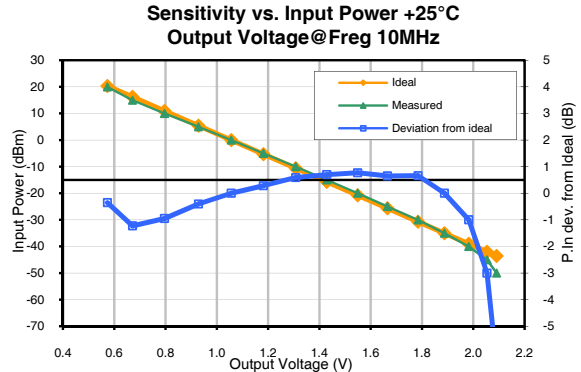
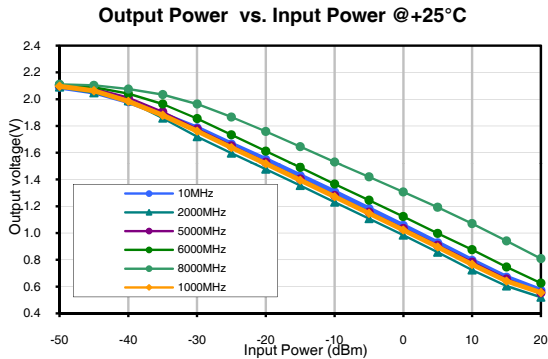

For detailed performance specs & shipping online see web site

P.O. Box 350166, Brooklyn, New York 11235-0003 (718) 634-4500 Fax (718) 332-4661 The Design Engineers Search Engine Provides ACTUAL Data Instantly at [minicircuits.com](http://minicircuits.com)

Notes: 1. Performance and quality attributes and conditions not expressly stated in this specification sheet are intended to be excluded and do not form a part of this specification sheet. 2. Electrical specifications and performance data contained herein are based on Mini-Circuits' applicable established test performance criteria and measurement instructions. 3. The parts covered by this specification sheet are subject to Mini-Circuits standard limited warranty and terms and conditions (collectively, "Standard Terms"); Purchasers of this part are entitled to the rights and benefits contained therein. For a full statement of the Standard Terms and the exclusive rights and remedies thereunder, please visit Mini-Circuits' website at [www.minicircuits.com/MCJ\\_Store-terms.jsp](http://www.minicircuits.com/MCJ_Store-terms.jsp).

# Power Detector

# ZX47-40LN+

## Typical Performance Curves

Slope Vs Input Power Over Temperature Range @ Freq 10MHz

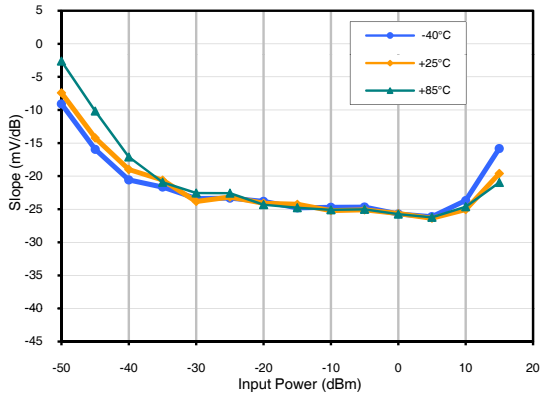

Slope Vs Freq Over Temperature Range @ Input Power -40dBm

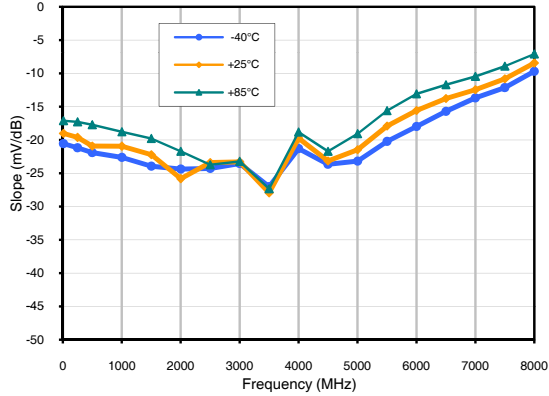

Slope Vs Input Power Over Temperature Range @ Freq 5000MHz

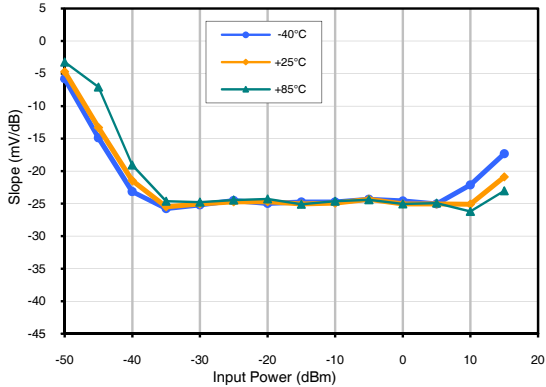

Slope Vs Freq Over Temperature Range @ Input Power -25dBm

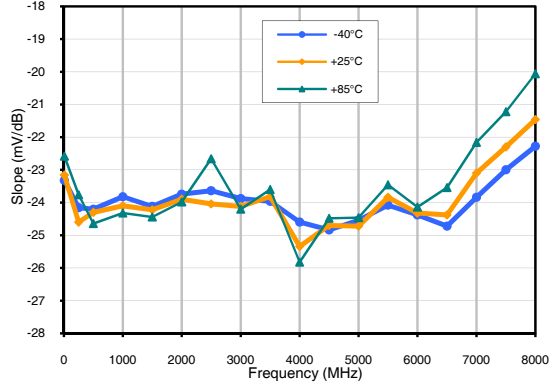

Slope Vs Input Power Over Temperature Range @ Freq 8000MHz

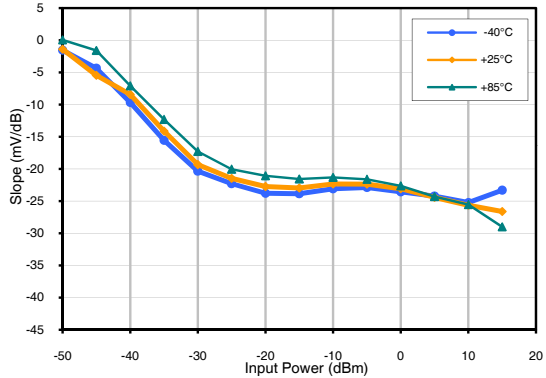

Slope Vs Freq Over Temperature Range @ Input Power 0dBm

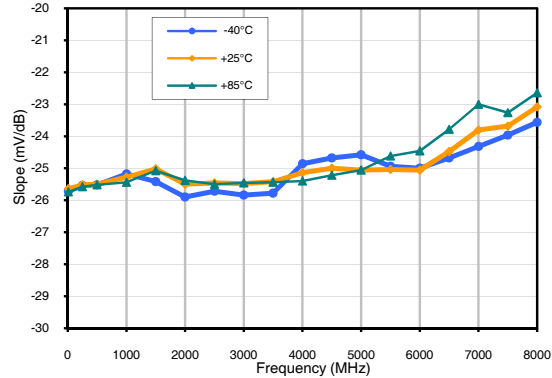

ISO 9001 ISO 14001 AS 9100 CERTIFIED

P.O. Box 350166, Brooklyn, New York 11235-0003 (718) 634-4500 Fax (718) 332-4661 The Design Engineers Search Engine Provides ACTUAL Data Instantly at [minicircuits.com](http://minicircuits.com)

IF/RF MICROWAVE COMPONENTS

For detailed performance specs & shopping online see web site

Notes: 1. Performance and quality attributes and conditions not expressly stated in this specification sheet are intended to be excluded and do not form a part of this specification sheet. 2. Electrical specifications and performance data contained herein are based on Mini-Circuits' applicable established test performance criteria and measurement instructions. 3. The parts covered by this specification sheet are subject to Mini-Circuits standard limited warranty and terms and conditions (collectively, "Standard Terms"); Purchasers of this part are entitled to the rights and benefits contained therein. For a full statement of the Standard Terms and the exclusive rights and remedies thereunder, please visit Mini-Circuits' website at [www.minicircuits.com/MCJ\\_Store-terms.jsp](http://www.minicircuits.com/MCJ_Store-terms.jsp).

## Typical Performance Curves

**Output Voltage Change Vs Input Power Over Temperature Range**

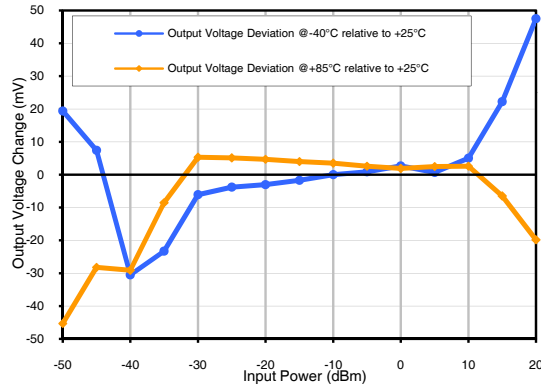

**VSWR Vs Freq Over Temperature Range**

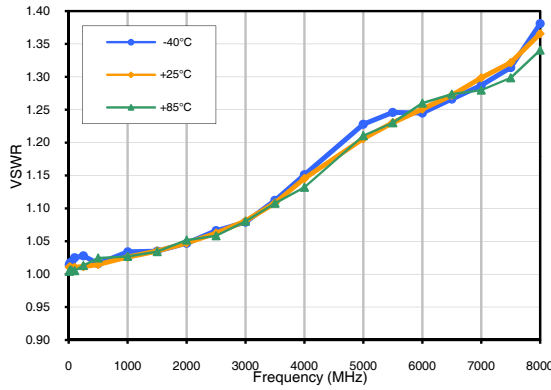

**Temperature Sensor Voltage Vs Ambient Temperature**

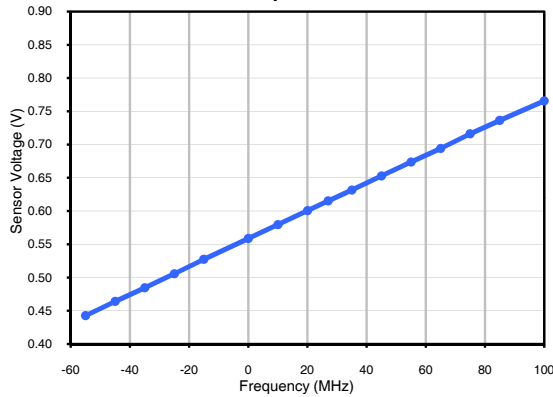

ISO 9001 ISO 14001 AS 9100 CERTIFIED

The Design Engineers Search Engine

IFIRF MICROWAVE COMPONENTS

For detailed performance specs & shopping online see web site

Provides ACTUAL Data Instantly at [minicircuits.com](http://minicircuits.com)

Notes: 1. Performance and quality attributes and conditions not expressly stated in this specification sheet are intended to be excluded and do not form a part of this specification sheet. 2. Electrical specifications and performance data contained herein are based on Mini-Circuit's applicable established test performance criteria and measurement instructions. 3. The parts covered by this specification sheet are subject to Mini-Circuits standard limited warranty and terms and conditions (collectively, "Standard Terms"); Purchasers of this part are entitled to the rights and benefits contained therein. For a full statement of the Standard Terms and the exclusive rights and remedies thereunder, please visit Mini-Circuits' website at [www.minicircuits.com/MCJ\\_Store-terms.jsp](http://www.minicircuits.com/MCJ_Store-terms.jsp).

# Case Style

# HN

## Outline Dimensions

## HN1173

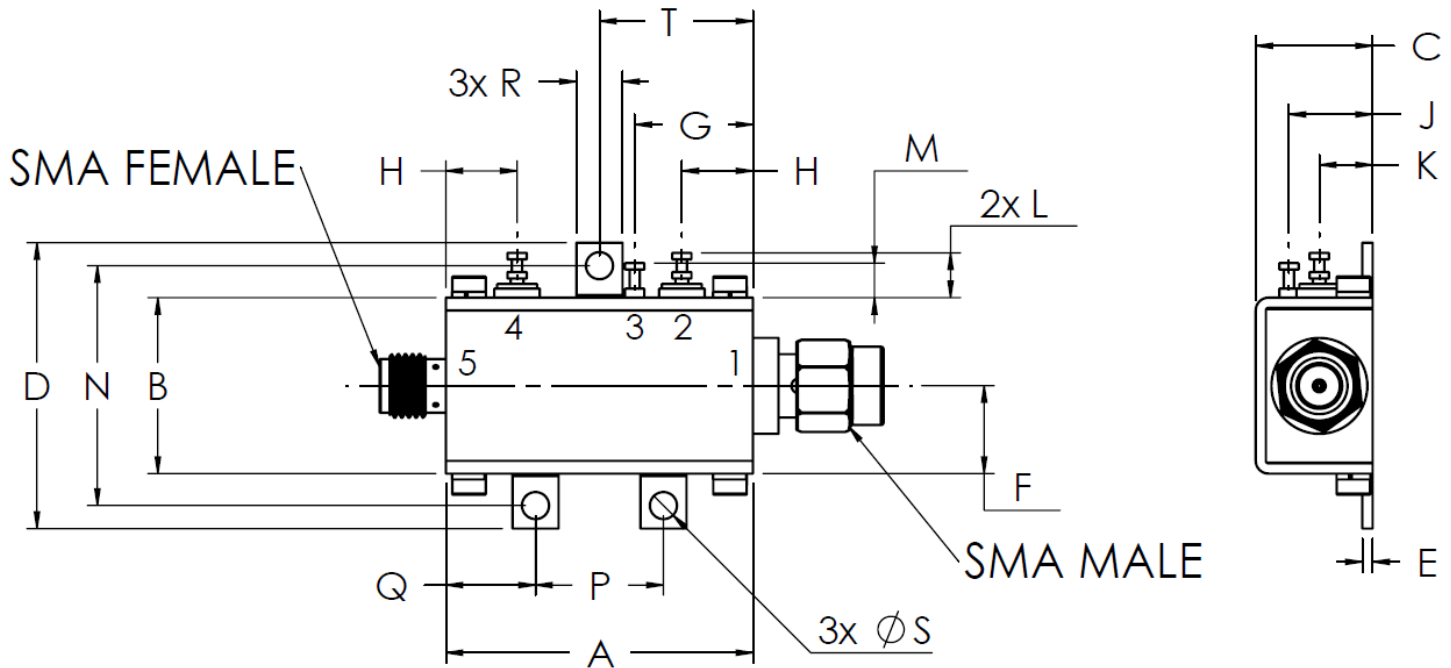

CASE #.	A	B	C	D	E	F	G	H	J	K	L	M	N
HN1173	1.20 (30.48)	.69 (17.53)	.46 (11.68)	1.12 (28.45)	.04 (1.02)	.34 (8.64)	.46 (11.68)	.28 (7.11)	.35 (8.89)	.21 (5.28)	.18 (4.57)	.14 (3.56)	.94 (23.88)

CASE #.	P	Q	R	S	T	WT GRAMS
HN1173	.50 (12.70)	.35 (8.89)	.18 (4.57)	.106 (2.69)	.60 (15.24)	31.8

Dimensions are in inches (mm). Tolerances: 2Pl.  $\pm .03$ ; 3Pl.  $\pm .015$   
Tolerance on hole size and interaxes dimensions to be  $\pm .005$ .

### Note:

1. Case material: Brass
2. Case finish: Nickel plate

**Mini-Circuits**<sup>®</sup>

INTERNET <http://www.minicircuits.com>

P.O. Box 350166, Brooklyn, New York 11235-0003 (718) 934-4500 Fax (718) 332-4661

Distribution Centers NORTH AMERICA 800-654-7949 • 417-335-5935 • Fax 417-335-5945 • EUROPE 44-1252-832600 • Fax 44-1252-837010

Mini-Circuits ISO 9001 & ISO 14001 Certified



All Mini-Circuits products are manufactured under exacting quality assurance and control standards, and are capable of meeting published specifications after being subjected to any or all of the following physical and environmental test.

Specification	Test/Inspection Condition	Reference/Spec
Operating Temperature	-40° to 85°C	Individual Model Data Sheet
Storage Temperature	-55° to 100° C Ambient Environment	Individual Model Data Sheet
Barometric Pressure	100,000 Feet	MIL-STD-202, Method 105, Condition D
Humidity	90% RH, 65°C Units may require bake-out after humidity to restore full performance.	MIL-STD-202, Method 103
Thermal Shock	-65° to 125°C, 5 cycles	MIL-STD-202, Method 107, Condition B
Vibration (High Frequency)	20g peak, 10-2000 Hz, 12 times in each of three perpendicular directions (total 36)	MIL-STD-202, Method 204, Condition D
Mechanical Shock	100g, 6ms sawtooth, 3 shocks each direction 3 axes (total 18)	MIL-STD-202, Method 213, Condition I