



COAXIAL

High Power Amplifier

ZVE-6W-83+ ZVE-6W-83X+

50Ω 2 to 8 GHz

THE BIG DEAL

- Extremely wideband, 2 to 8 GHz
- Flat Gain, 33 ±2 dB typ.
- High IP3, +40 dBm typ.
- 6W Pout at saturation typ.



Generic photo used for illustration purposes only

APPLICATIONS

- Radar and military
- Test instrumentation
- 5G Sub6
- WiFi 6E

Model No.	ZVE-6W-83+	ZVE-6W-83X+▲
Option	With heatsink & fan	Without heatsink & fan
Case Style	CP1978-1	
Connectors	SMA-Female	

+RoHS Compliant
The +Suffix identifies RoHS Compliance. See our web site for RoHS Compliance methodologies and qualifications

PRODUCT OVERVIEW

Mini-Circuits' ZVE-6W-83+ is a Class-A, four-stage, unconditionally stable amplifier providing flat gain over a wide frequency range from 2 to 8 GHz. This model is capable of delivering up to 6W output power at P_{sat} with high IP3 supporting a wide range of systems where high performance over wideband is needed. It operates on a +15V supply and features built-in safety features including protection against reverse bias and immunity to accidental open or short loads. The amplifier comes in a rugged, compact case (2.61 x 2.43 x 0.74") with SMA connectors and an optional heat sink for efficient cooling.

KEY FEATURES

Feature	Advantages
Wideband, 2 to 8 GHz Able to work from 1.5 to 9 GHz	Enables a single amplifier to be used in a wide range of applications.
Excellent gain flatness, ±2.0 dB across full frequency range	Provides consistent performance across its operating frequency, minimizing the need for external equalizing networks in wideband applications.
High gain, 33 dB typ.	Reduces the number of gain stages, lowering component count and overall system cost.
Class AB Amplifier	Provides good linearity with low signal distortion.
Rugged design	Built-in protection against reverse bias and accidental open and short loads provides added reliability for demanding operating conditions.



COAXIAL

High Power Amplifier

ZVE-6W-83+ ZVE-6W-83X+

Mini-Circuits

ELECTRICAL SPECIFICATIONS AT 25°C

Parameter	Condition (GHz)	ZVE-6W-83+ ZVE-6W-83X+ [▲]			Units
		Min.	Typ.	Max.	
Frequency Range		2	–	8	GHz
Gain	2 - 8	29	33	41	dB
Gain Flatness	2 - 8	–	±2.0	±3.5	dB
Output Power at 1dB compression ³	2 - 8	34	37	–	dBm
Output Power at Saturation	2 - 8	37	40	–	dBm
Noise Figure	2 - 8	–	10	12	dB
Output third order intercept point	2 - 8	–	40	–	dBm
Input VSWR	2 - 8	–	1.9	2.5	:1
Output VSWR	2 - 8	–	1.4	2.5	:1
DC Supply Voltage		14	15 ²	16	V
Supply Current ¹		–	0.8	5	A

1. Power Supply should be capable of delivering 15V 5A at start-up.

2. Recommended Operating Voltage.

3. P1dB is specified in reference to Pout = 30 dBm.

[▲]Heat sink and fan not included. Alternative heat sinking and heat removal must be provided by the user to limit maximum base-plate temperature to 85°C, in order to ensure proper performance. For reference, this requires thermal resistance of user's external heat sink to be 0.3°C/W max.

MAXIMUM RATINGS

Parameter	Ratings
Operating Temperature	ZVE-6W-83+ -40°C to 60°C ambient
	ZVE-6W-83X+ -40°C to 85°C base plate temp.
Storage Temperature	-55°C to 125°C
DC Voltage	18V
CW Input RF Power (no damage)	+20 dBm @ load
	0 dBm @ open / short

Permanent damage may occur if any of these limits are exceeded.





COAXIAL

High Power Amplifier

ZVE-6W-83+ ZVE-6W-83X+

OUTLINE DRAWING FOR MODELS WITH HEATSINK & FAN (ZVE-6W-83+)

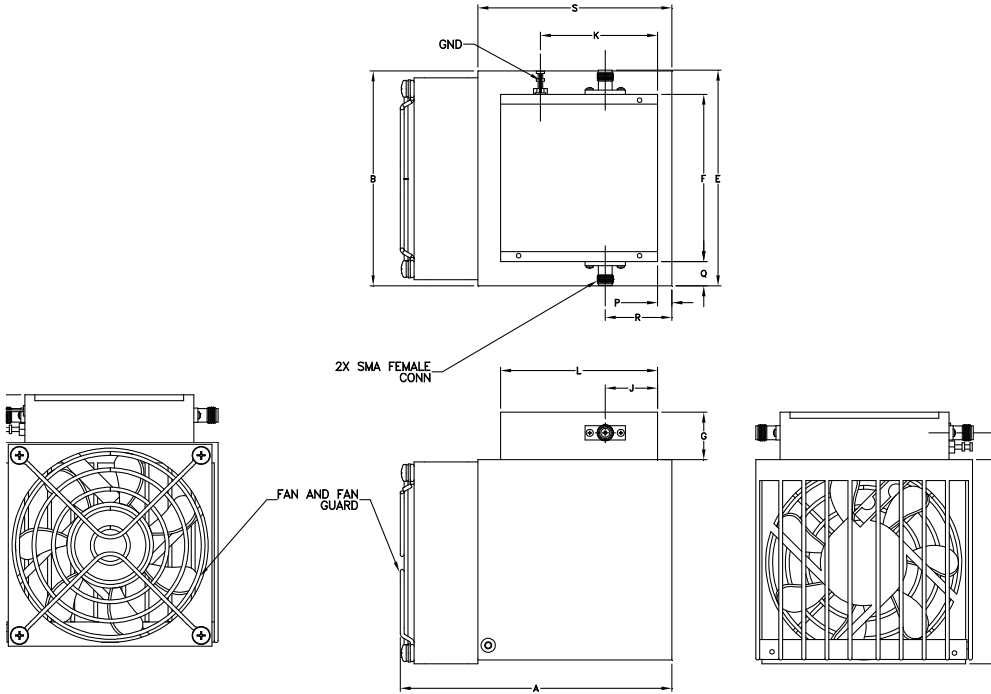

MOUNTING INFORMATION FOR MODELS WITHOUT HEATSINK & FAN (ZVE-6W-83X+)

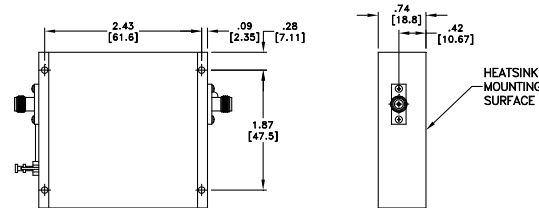

OUTLINE DIMENSIONS (inch/mm)

A	B	C	D	E	F	G	J	
4.20	3.35	3.92	3.60	3.36	2.61	.74	.81	
106.68	85.09	99.57	91.44	85.34	66.29	18.80	20.57	
K	L	N	P	Q	R	S	wt	
1.81	2.43	.42	.22	.38	1.03	3.00	grams*	
45.97	61.72	10.67	5.59	9.65	26.16	76.20	750.0	

*290 grams without heatsink



COAXIAL

High Power Amplifier

ZVE-6W-83+ ZVE-6W-83X+

TYPICAL PERFORMANCE DATA/CURVES

Frequency (MHz)	Gain (dB)	Directivity (dB)	VSWR (:1)		Pout at 1 dB Compr. (dBm)	Pout at Saturation (dBm)	Noise Figure (dB)	OIP3 (dBm)
	15V		IN	OUT	15V	15V		15V
2000	34.64	54.82	1.96	1.63	38.85	41.38	9.90	43.18
2500	36.22	42.11	1.77	1.22	38.96	41.03	7.88	40.26
3000	34.21	39.25	1.91	1.24	38.38	40.27	7.23	40.30
3500	35.39	35.29	1.85	1.33	37.88	40.33	6.19	39.76
4000	36.48	36.29	1.46	1.39	37.92	40.22	5.48	39.00
4500	36.71	37.06	1.02	1.20	38.82	40.94	5.41	39.36
5000	36.17	44.52	1.33	1.01	39.99	41.56	5.41	40.75
5500	35.33	56.18	1.50	1.27	39.33	41.12	5.65	40.66
6000	34.33	53.75	1.38	1.33	39.06	40.56	5.81	40.57
6500	33.54	53.75	1.02	1.32	38.25	40.25	5.99	40.06
7000	33.14	50.83	1.19	1.32	37.76	40.08	6.14	39.55
7500	33.86	44.23	1.46	1.21	38.31	40.56	6.12	39.81
8000	34.21	46.86	1.64	1.59	38.31	40.55	5.97	41.08

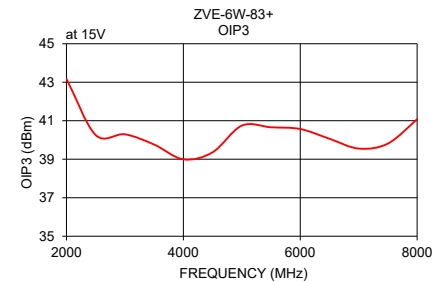
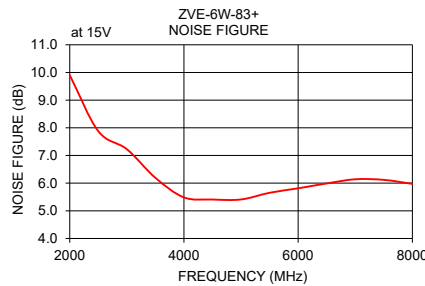
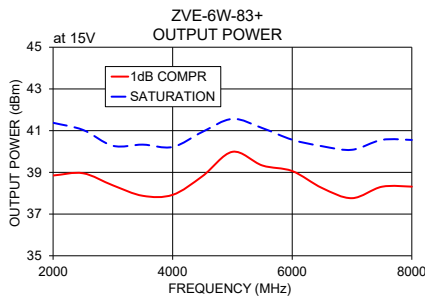
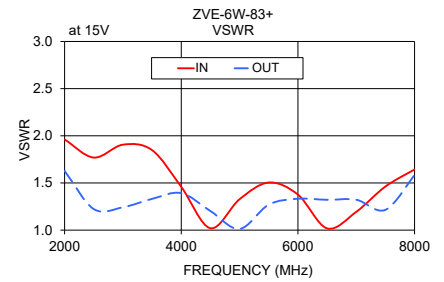
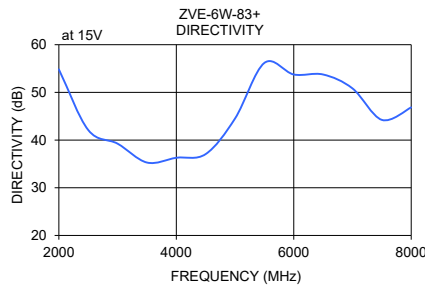
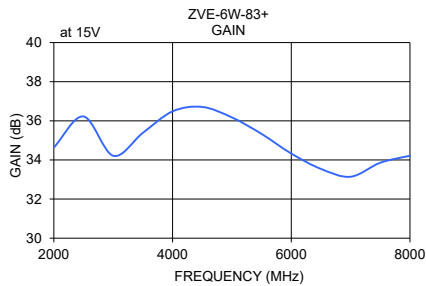

- NOTES**
- A. Performance and quality attributes and conditions not expressly stated in this specification document are intended to be excluded and do not form a part of this specification document.
 - B. Electrical specifications and performance data contained in this specification document are based on Mini-Circuit's applicable established test performance criteria and measurement instructions.
 - C. The parts covered by this specification document are subject to Mini-Circuits standard limited warranty and terms and conditions (collectively, "Standard Terms"); Purchasers of this part are entitled to the rights and benefits contained therein. For a full statement of the standard. Terms and the exclusive rights and remedies thereunder, please visit Mini-Circuits' website at www.minicircuits.com/terms/viewterm.html



Typical Performance Data

FREQUENCY (MHz)	GAIN (dB) 15V	DIRECTIVITY (dB) 15V	VSWR (:1)		NOISE FIGURE (dB) 15V	POUT @ 1 dB COMPRESSION (dBm) 15V	POUT @ SATURATION (dBm) 15V	OUTPUT IP3 (dBm) 15V
			IN 15V	OUT 15V				
1500	24.86	72.45	2.36	2.41	14.30	34.39	36.22	37.09
1600	27.33	70.54	2.31	2.25	13.27	35.47	38.07	39.35
1700	29.68	66.11	2.25	2.09	12.39	37.01	39.63	41.77
1800	31.74	60.16	2.15	1.93	11.50	38.03	40.31	43.10
1900	33.39	56.60	2.06	1.77	10.64	38.57	40.74	43.15
2000	34.64	54.82	1.96	1.63	9.90	38.85	41.38	43.18
2100	35.48	50.38	1.89	1.49	9.33	38.88	41.43	42.16
2200	35.98	47.85	1.84	1.35	8.75	38.95	41.52	41.65
2300	36.20	46.07	1.81	1.25	8.42	39.25	41.49	41.33
2400	36.28	43.28	1.79	1.22	8.10	39.26	41.28	40.69
2500	36.22	42.11	1.77	1.22	7.88	38.96	41.03	40.26
2600	35.99	40.98	1.78	1.22	7.74	38.77	40.80	39.96
2700	35.54	41.24	1.83	1.19	7.52	38.63	40.64	39.80
2800	35.03	40.52	1.87	1.17	7.46	38.50	40.49	39.79
2900	34.56	39.65	1.90	1.19	7.32	38.54	40.44	39.88
3000	34.21	39.25	1.91	1.24	7.23	38.38	40.27	40.30
3100	34.09	38.95	1.88	1.29	6.98	38.22	40.17	40.28
3200	34.19	38.12	1.84	1.34	6.83	38.07	40.17	40.16
3300	34.47	37.20	1.81	1.36	6.61	37.95	40.14	40.02
3400	34.88	36.02	1.82	1.36	6.39	38.02	40.14	39.99
3500	35.39	35.29	1.85	1.33	6.19	37.88	40.33	39.76
3600	35.87	35.31	1.87	1.30	6.03	37.70	40.25	39.53
3700	36.22	35.37	1.84	1.30	5.82	37.52	40.12	39.58
3800	36.43	34.48	1.74	1.33	5.69	37.61	40.26	39.33
3900	36.49	35.09	1.60	1.37	5.54	37.70	40.21	39.10
4000	36.48	36.29	1.46	1.39	5.48	37.92	40.22	39.00
4100	36.47	36.80	1.33	1.38	5.41	38.25	40.42	38.82
4200	36.51	37.52	1.22	1.33	5.34	38.38	40.61	38.54
4300	36.58	38.11	1.14	1.28	5.38	38.19	40.49	38.29
4400	36.65	36.74	1.06	1.23	5.39	38.45	40.77	38.55
4500	36.71	37.06	1.02	1.20	5.41	38.82	40.94	39.36
4600	36.69	36.39	1.07	1.19	5.38	39.10	41.13	39.87
4700	36.59	36.89	1.13	1.16	5.39	39.41	41.27	40.10
4800	36.45	38.44	1.21	1.12	5.39	39.67	41.42	40.36
4900	36.32	40.67	1.27	1.07	5.46	39.88	41.51	40.56
5000	36.17	44.52	1.33	1.01	5.41	39.99	41.56	40.75
5100	36.03	45.83	1.37	1.06	5.47	39.94	41.53	40.83
5200	35.88	48.18	1.41	1.13	5.53	39.90	41.57	41.04
5300	35.73	48.64	1.45	1.19	5.49	39.64	41.38	41.26
5400	35.54	48.97	1.48	1.23	5.64	39.52	41.20	40.86
5500	35.33	56.18	1.50	1.27	5.65	39.33	41.12	40.66
5600	35.10	54.65	1.52	1.29	5.70	39.16	40.81	40.59
5700	34.86	58.79	1.51	1.31	5.77	39.19	40.79	40.71
5800	34.66	53.47	1.49	1.32	5.72	39.17	40.75	40.65
5900	34.47	54.17	1.44	1.32	5.81	39.21	40.62	40.49
6000	34.33	53.75	1.38	1.33	5.81	39.06	40.56	40.57
6100	34.19	52.29	1.30	1.33	5.87	38.82	40.52	40.49
6200	34.04	52.86	1.22	1.33	5.88	38.60	40.37	40.46
6300	33.89	52.34	1.14	1.32	5.94	38.34	40.35	40.36
6400	33.71	53.19	1.08	1.32	5.95	38.29	40.34	40.11
6500	33.54	53.75	1.02	1.32	5.99	38.25	40.25	40.06
6600	33.38	54.21	1.03	1.34	6.04	38.03	40.14	39.96
6700	33.26	54.40	1.07	1.36	6.07	37.97	40.05	39.83
6800	33.19	53.20	1.11	1.37	6.02	37.70	39.97	39.66
6900	33.15	51.64	1.15	1.36	6.14	37.65	39.87	39.55
7000	33.14	50.83	1.19	1.32	6.14	37.76	40.08	39.55
7100	33.17	49.44	1.24	1.27	6.19	37.96	40.10	39.69
7200	33.26	48.29	1.29	1.22	6.19	38.07	40.16	39.61
7300	33.40	48.12	1.34	1.20	6.17	38.19	40.32	39.78
7400	33.61	46.02	1.40	1.21	6.18	38.34	40.43	39.94
7500	33.86	44.23	1.46	1.21	6.12	38.31	40.56	39.81
7600	34.10	43.89	1.53	1.18	6.13	38.47	40.60	39.99
7700	34.27	44.44	1.59	1.17	6.10	38.49	40.68	40.08
7800	34.29	44.45	1.61	1.28	6.05	38.54	40.68	40.46
7900	34.22	45.20	1.62	1.46	5.99	38.45	40.40	40.71
8000	34.21	46.86	1.64	1.59	5.97	38.31	40.55	41.08
8100	34.42	48.73	1.69	1.59	5.91	38.15	40.39	41.13
8200	34.84	50.09	1.74	1.46	5.83	37.83	40.13	40.84
8300	35.25	54.93	1.74	1.35	5.83	37.84	40.35	41.13
8400	35.27	64.64	1.70	1.47	5.80	37.49	39.86	40.63
8500	34.86	60.43	1.66	1.72	5.77	37.34	39.38	40.27
8600	34.01	50.60	1.64	1.93	5.75	36.75	38.95	39.99
8700	32.59	48.00	1.62	1.94	5.81	36.19	37.89	38.32
8800	30.46	49.97	1.61	1.71	5.81	34.95	36.67	36.31
8900	27.44	53.83	1.64	1.49	5.96	33.51	34.97	33.90
9000	24.20	58.18	1.67	1.44	6.09	32.03	33.21	32.21



P.O. Box 350166, Brooklyn, New York 11235-0003 (718) 934-4500 • Fax (718) 332-4661 For detailed performance specs & shopping online see Mini-Circuits web site



The Design Engineers Search Engine Provides ACTUAL Data Instantly From MINI-CIRCUITS At: www.minicircuits.com

IF/RF MICROWAVE COMPONENTS

Typical Performance Curves

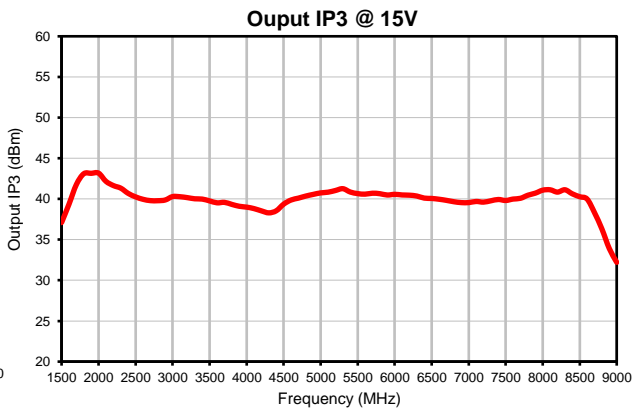
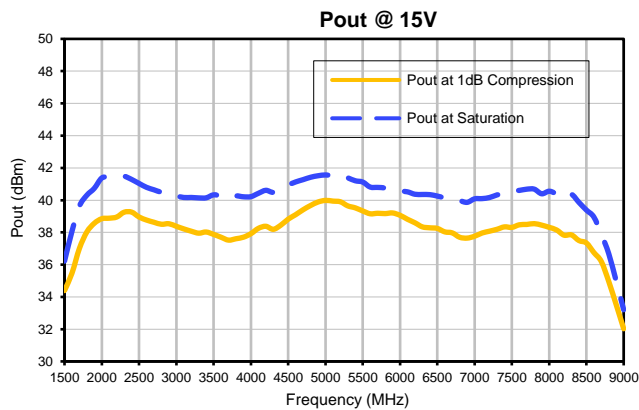
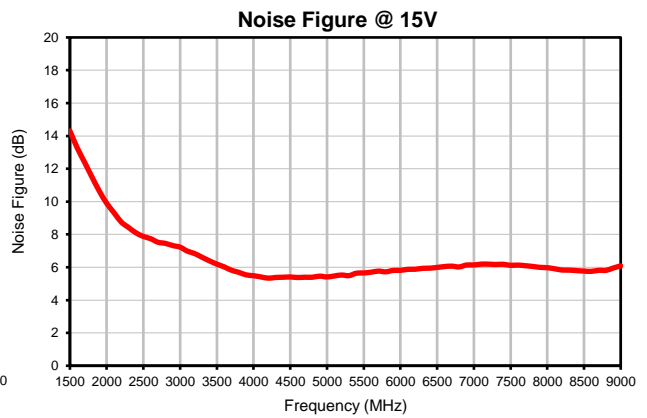
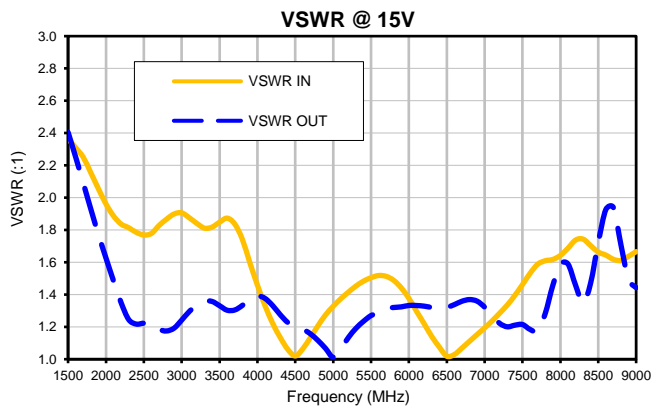
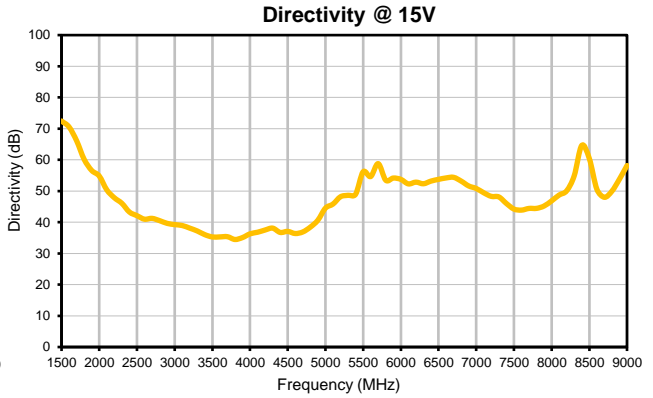
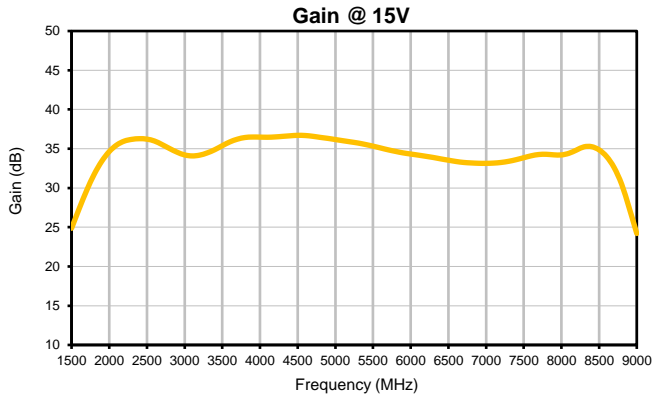

Outline Dimensions

CP1978-1

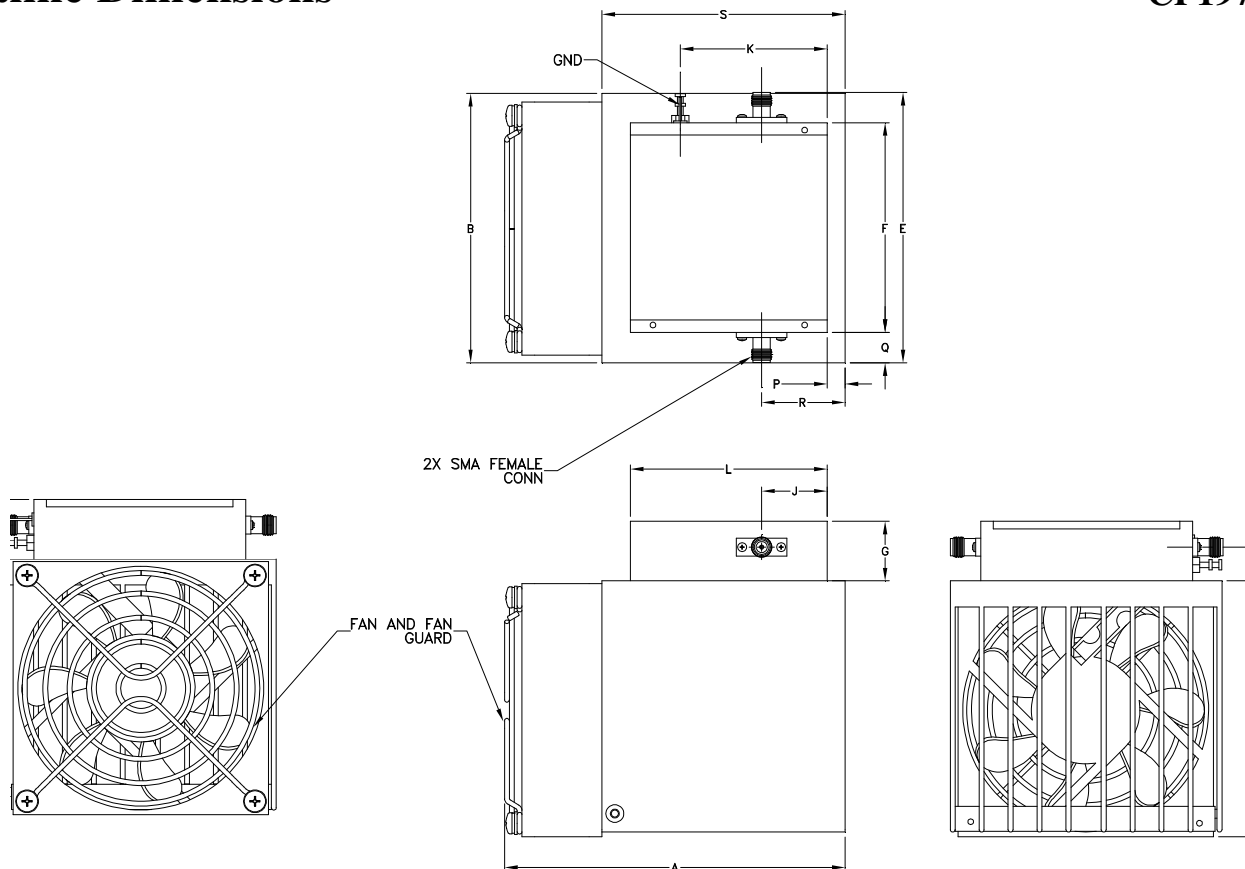

MOUNTING INFORMATION OF MODEL WITHOUT HEATSINK

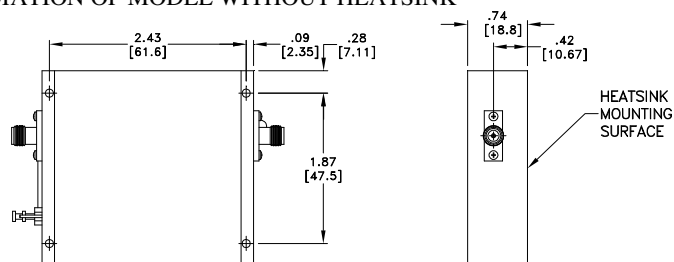

CASE#	A	B	C	D	E	F	G	H	J	K	L	M	N
CP1978-1	4.20 (106.7)	3.35 (85.09)	3.92 (99.63)	3.60 (91.5)	3.36 (85.41)	2.61 (66.29)	.74 (18.8)	--	.81 (20.57)	1.81 (46.05)	2.43 (61.72)	--	.42 (10.67)
CASE#	P	Q	R	S	T	WT. GRAMS	WT. WITHOUT HEATSINK GRAMS						
CP1978-1	.22 (5.59)	.38 (9.59)	1.03 (26.16)	3.00 (76.2)	--	750	290						

Notes:

1. Case material: Aluminum alloy.
2. Case finish: Electroless Nickel.
3. Heat sink finish: Black anodize if supplied with heat sink



P.O. Box 350166, Brooklyn, New York 11235-0003 (718) 934-4500 Fax (718) 332-4661 For detailed performance specs & shopping online see Mini-Circuits web site



The Design Engineers Search Engine Provides ACTUAL Data Instantly From MINI-CIRCUITS At: www.minicircuits.com

RF/IF MICROWAVE COMPONENTS



All Mini-Circuits products are manufactured under exacting quality assurance and control standards, and are capable of meeting published specifications after being subjected to any or all of the following physical and environmental test.

Specification	Test/Inspection Condition	Reference/Spec
Operating Temperature	-40° to 85° C Ambient Environment	Individual Model Data Sheet
Base Plate Temperature	85°C	---
Storage Temperature	-55° to 125° C Ambient Environment	Individual Model Data Sheet
Stabilization Bake	(non-operating) 125°C, 24 hours	---
Burn-in at Elevated Temp.	(DC on) 160 hours at 85° C	MIL-STD-202, Method 108
Thermal Shock	-55° to 100°C, 5 cycles	MIL-STD-202, Method 107, Condition A, except 100°C