



SUPER ULTRA

Wideband Amplifier

ZVE-143-S+ ZVE-143X-S+

FEATURES

- Wideband, 8 to 14 GHz
- High Output IP3, +35 dBm typ.
- Rugged Compact Case
- Unconditionally Stable

APPLICATIONS

- Radar and Military
- Test Instrumentation
- Satellite Repeaters
- Communication



Generic photo used for illustration purposes only

Model No.	ZVE-143-S+	ZVE-143X-S+▲
Option	With heatsink	Without heatsink
Case Style	AV243	
Connectors	SMA	

+RoHS Compliant

The +Suffix identifies RoHS Compliance.
See our website for methodologies and qualifications

PRODUCT OVERVIEW

Mini-Circuits' ZVE-143-S+ is a Class-A, two-stage, unconditionally stable amplifier providing flat gain over an extremely wide frequency range from 8 to 14 GHz. This model is capable of delivering up to 0.6W output power at P1dB with high output IP3 supporting a wide range of sensitive, high-dynamic range receiver applications and many systems where high performance over wideband is needed. It operates on a +12V supply and features built-in safety features including protection against reverse bias and immunity to accidental open or short loads for 2 minutes. The amplifier comes in a rugged, compact case (1.05 x 1.01 x 0.35") with SMA connectors and an optional heat sink for efficient cooling.

KEY FEATURES

Feature	Advantages
Ultra-wideband, 8 to 14 GHz able to work from 5.0 to 14.5 GHz	Enables a single amplifier to be used in a wide range of applications.
Excellent gain flatness, ± 0.8 dB typ. across full frequency range	Provides consistent performance across its operating frequency, minimizing the need for external equalizing networks in wideband applications.
High gain, 19 dB typ.	Reduces the number of gain stages, lowering component count and overall system cost.
Class A Amplifier	Provides good linearity with low signal distortion.
Low Noise and High IP3: • NF, 4.5 dB typ. • OIP3, +35 dBm typ.	The combination of low noise and high IP3 makes the ZVE-143-S+ ideal for use in low noise receiver front end (RFE) as it gives the user the advantages of sensitivity and two-tone IM performance at both ends of the dynamic range.
Rugged design	Built-in protection against reverse bias and accidental open and short loads provides added reliability for demanding operating conditions.



SUPER ULTRA

Wideband Amplifier

ZVE-143-S+ ZVE-143X-S+

ELECTRICAL SPECIFICATIONS AT +25°C

Parameter	Condition (GHz)	ZVE-143-S+ ZVE-143X-S+ [▲]			Units
		Min.	Typ.	Max.	
Frequency Range		8		14	GHz
Gain	8 - 14	16	19	22	dB
Gain Flatness	8 - 14	—	±0.8	±1.5	dB
Input VSWR	8 - 14	—	1.5	2.5	:1
Output VSWR	8 - 14	—	1.5	2.5	:1
Output Power at 1dB Compression	8 - 14	+26	+28	—	dBm
Output Power at 3 dB Compression	8 - 14	—	+35	—	dBm
Noise Figure	8 - 14	—	4.5	5.5	dB
DC Supply Voltage		+10	+12 ¹	+17	V
Supply Current		—	350	450	mA

1. Recommended Operating Voltage.

[▲] Heat sink not included. Alternative heat sinking and heat removal must be provided by the user to limit maximum base-plate temperature to 85°C, in order to ensure proper performance. For reference, this requires thermal resistance of user's external heat sink to be 7.7°C/W max.

ABSOLUTE MAXIMUM RATINGS

Parameter	Ratings
Operating Temperature	ZVE-143-S+ -40°C to +54°C ambient ZVE-143X-S+ -40°C to +85°C base plate temp.
Storage Temperature	-65°C to +125°C
DC Voltage	+17 V
CW Input RF Power (no damage)	+15 dBm

Permanent damage may occur if any of these limits are exceeded.





SUPER ULTRA

Wideband Amplifier

ZVE-143-S+ ZVE-143X-S+

OUTLINE DRAWING FOR MODELS WITH HEATSINK (ZVE-143-S+)

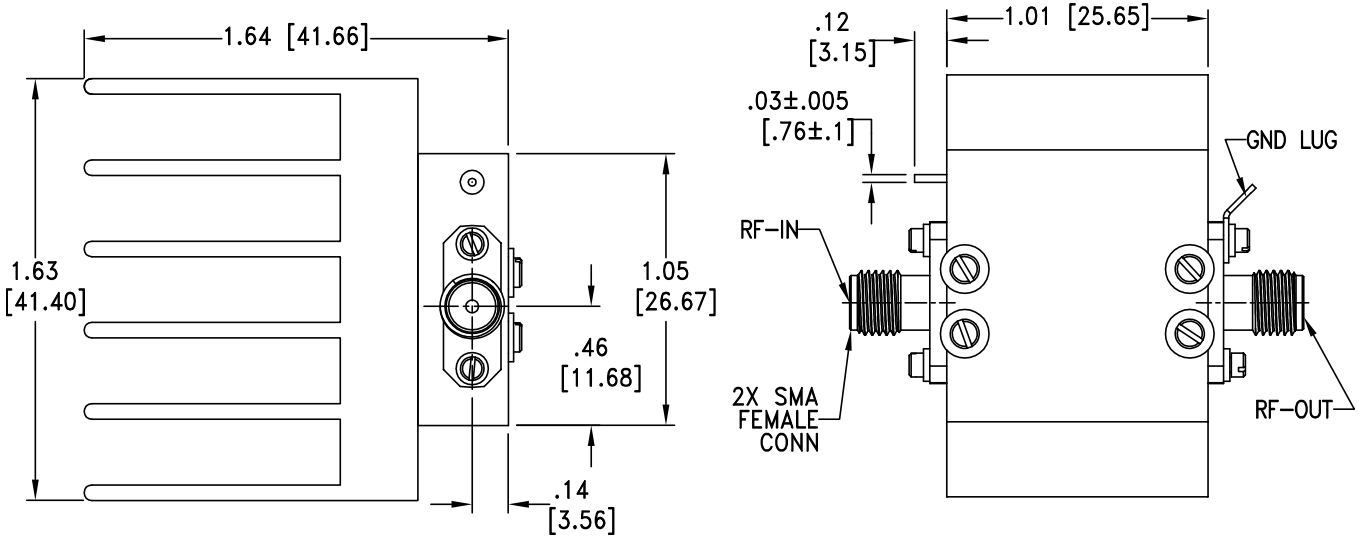

MOUNTING INFORMATION FOR MODELS WITHOUT HEATSINK (ZVE-143X-S+)

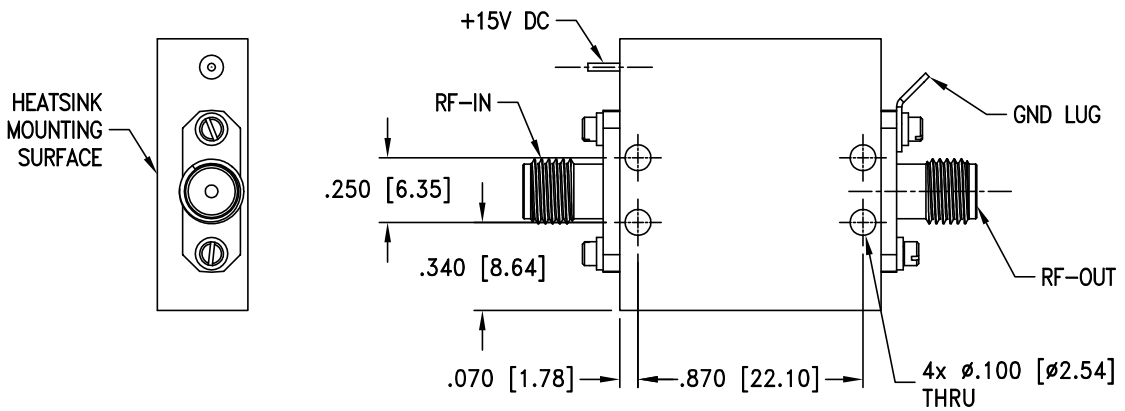

Weight: 58 grams; Weight without heatsink: 17 grams

Dimensions are in inches [mm]



SUPER ULTRA

Wideband Amplifier

ZVE-143-S+ ZVE-143X-S+

Mini-Circuits

50Ω 8 to 14 GHz

TYPICAL PERFORMANCE DATA/CURVES

Frequency (MHz)	Gain (dB)	Directivity (dB)	VSWR (:1)		Pout at 1 dB Compr. (dBm)	Pout at 3 dB Compr. (dBm)	Noise Figure (dB)	OIP3 (dBm)
	12V	12V	IN	OUT	12V	12V	12V	12V
8000	19.61	20.50	1.37	1.24	28.89	29.91	3.16	36.94
8600	19.39	20.73	1.57	1.46	28.67	29.86	3.34	36.94
9000	19.70	20.48	1.45	1.48	28.84	29.91	3.49	36.73
9600	19.91	19.65	1.21	1.39	28.98	29.74	3.44	36.30
10000	19.61	20.58	1.25	1.40	28.84	29.55	3.41	36.30
10600	19.10	22.29	1.34	1.51	28.67	29.26	3.59	35.97
11000	18.98	23.08	1.29	1.49	28.33	29.38	3.65	35.29
11600	18.90	23.77	1.28	1.35	28.82	29.69	3.74	34.74
12000	18.91	23.41	1.27	1.34	28.82	29.72	3.73	34.75
12600	19.20	21.42	1.18	1.40	29.00	29.96	3.65	34.60
13000	19.40	19.82	1.12	1.40	29.10	29.93	3.68	34.51
13600	19.34	18.26	1.38	1.34	29.14	29.82	3.56	34.03
14000	18.83	18.28	1.59	1.32	29.12	29.53	3.52	34.51

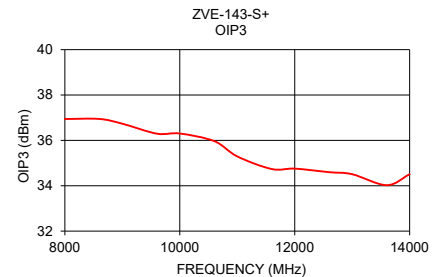
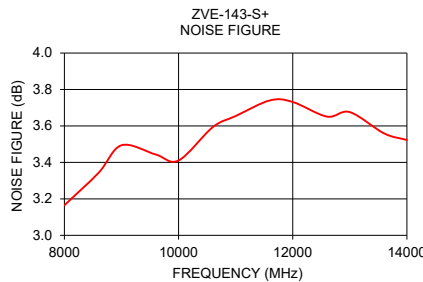
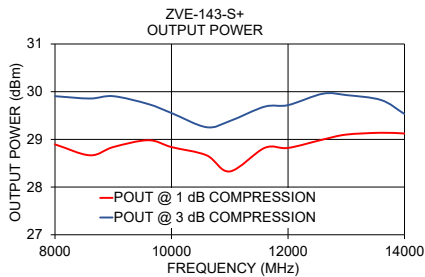
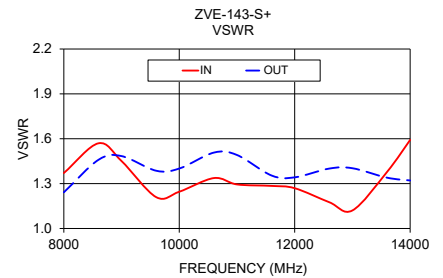
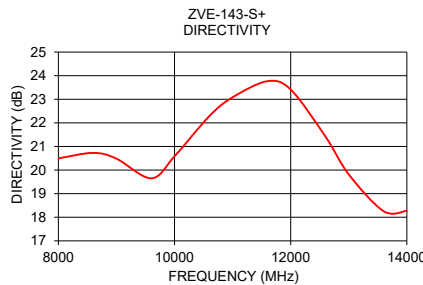
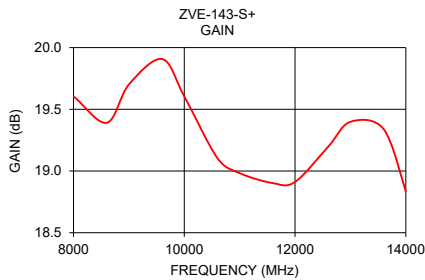

- NOTES**
- A. Performance and quality attributes and conditions not expressly stated in this specification document are intended to be excluded and do not form a part of this specification document.
 - B. Electrical specifications and performance data contained in this specification document are based on Mini-Circuit's applicable established test performance criteria and measurement instructions.
 - C. The parts covered by this specification document are subject to Mini-Circuits standard limited warranty and terms and conditions (collectively, "Standard Terms"); Purchasers of this part are entitled to the rights and benefits contained therein. For a full statement of the standard. Terms and the exclusive rights and remedies thereunder, please visit Mini-Circuits' website at www.minicircuits.com/terms/viewterm.html



Typical Performance Data

FREQUENCY (MHz)	GAIN (dB) 12V	DIRECTIVITY (dB) 12V	VSWR (:1)		NOISE FIGURE (dB) 12V	POUT @ 1 dB COMPRESSION (dBm) 12V	POUT @ 3 dB COMPRESSION (dBm) 12V	OUTPUT IP3 (dBm) 12V
			IN 12V	OUT 12V				
4000	22.57	27.59	6.68	1.82	4.55	26.22	28.42	37.35
4200	22.47	27.81	5.85	1.80	4.26	26.66	28.51	37.59
4400	22.48	28.05	4.95	1.75	4.06	27.11	28.83	37.30
4600	22.56	28.64	4.13	1.68	3.81	27.51	28.95	36.90
4800	22.66	29.55	3.44	1.61	3.59	27.62	28.94	36.81
5000	22.74	31.13	2.91	1.54	3.47	27.82	29.08	36.49
5200	22.81	33.89	2.46	1.50	3.28	28.51	29.33	36.51
5400	22.82	38.93	2.10	1.47	3.12	28.20	29.39	36.48
5600	22.77	49.56	1.81	1.46	2.97	28.36	29.44	36.49
5800	22.66	38.33	1.59	1.48	2.89	28.21	29.44	36.55
6000	22.51	32.40	1.41	1.51	2.83	28.76	29.39	36.63
6200	22.30	28.80	1.31	1.55	2.80	28.78	29.61	36.62
6400	22.06	26.41	1.24	1.58	2.79	28.73	29.42	36.57
6600	21.80	24.57	1.21	1.60	2.82	28.62	29.50	36.60
6800	21.51	23.16	1.21	1.58	2.83	28.78	29.64	36.62
7000	21.19	22.09	1.19	1.53	2.87	28.73	29.59	36.57
7200	20.86	21.37	1.14	1.45	2.99	28.78	29.35	36.50
7400	20.50	20.90	1.14	1.35	3.04	28.82	29.67	36.56
7600	20.14	20.63	1.19	1.26	3.10	29.00	29.75	36.75
7800	19.83	20.53	1.27	1.22	3.17	29.02	29.82	36.82
8000	19.61	20.50	1.37	1.24	3.16	28.89	29.91	36.94
8200	19.49	20.50	1.47	1.31	3.28	28.89	30.11	36.99
8400	19.49	20.53	1.53	1.38	3.36	28.74	29.87	37.20
8600	19.39	20.73	1.57	1.46	3.34	28.67	29.86	36.94
8800	19.56	20.75	1.51	1.47	3.42	28.70	29.82	36.81
9000	19.70	20.48	1.45	1.48	3.49	28.84	29.91	36.73
9200	19.86	19.53	1.38	1.47	3.50	28.89	29.91	36.69
9400	19.94	19.37	1.28	1.42	3.44	28.95	30.07	36.37
9600	19.91	19.65	1.21	1.39	3.44	28.98	29.74	36.30
9800	19.78	20.03	1.21	1.38	3.44	28.90	29.76	36.39
10000	19.61	20.58	1.25	1.40	3.41	28.84	29.55	36.30
10200	19.41	21.18	1.29	1.44	3.48	28.86	29.77	36.40
10400	19.23	21.78	1.33	1.48	3.47	28.71	29.67	36.19
10600	19.10	22.29	1.34	1.51	3.59	28.67	29.26	35.97
10800	19.02	22.72	1.32	1.51	3.61	28.43	29.26	35.58
11000	18.98	23.08	1.29	1.49	3.65	28.33	29.38	35.29
11200	18.96	23.40	1.28	1.45	3.70	28.62	29.50	35.21
11400	18.93	23.63	1.28	1.39	3.72	28.89	29.58	34.92
11600	18.90	23.77	1.28	1.35	3.74	28.82	29.69	34.74
11800	18.89	23.67	1.28	1.34	3.70	28.87	29.62	34.82
12000	18.91	23.41	1.27	1.34	3.73	28.82	29.72	34.75
12200	18.97	22.89	1.24	1.36	3.67	28.91	29.67	34.69
12400	19.08	22.23	1.21	1.38	3.74	28.99	29.75	34.61
12600	19.20	21.42	1.18	1.40	3.65	29.00	29.96	34.60
12800	19.31	20.59	1.14	1.41	3.62	29.05	29.95	34.61
13000	19.40	19.82	1.12	1.40	3.68	29.10	29.93	34.51
13200	19.44	19.16	1.16	1.38	3.61	29.16	29.88	34.35
13400	19.43	18.61	1.26	1.36	3.56	29.16	29.88	34.13
13600	19.34	18.26	1.38	1.34	3.56	29.14	29.82	34.03
13800	19.15	18.16	1.49	1.33	3.58	29.01	29.64	34.41
14000	18.83	18.28	1.59	1.32	3.52	29.12	29.53	34.51
14200	18.36	18.83	1.65	1.32	3.68	29.01	29.37	34.35
14400	17.72	19.73	1.69	1.30	3.63	28.89	29.09	34.25
14600	16.85	21.11	1.78	1.26	3.81	28.64	28.70	33.98
14800	15.81	22.87	1.96	1.19	3.85	28.08	28.35	34.02
15000	14.66	24.82	2.16	1.09	4.05	27.29	27.25	36.47

Typical Performance Curves

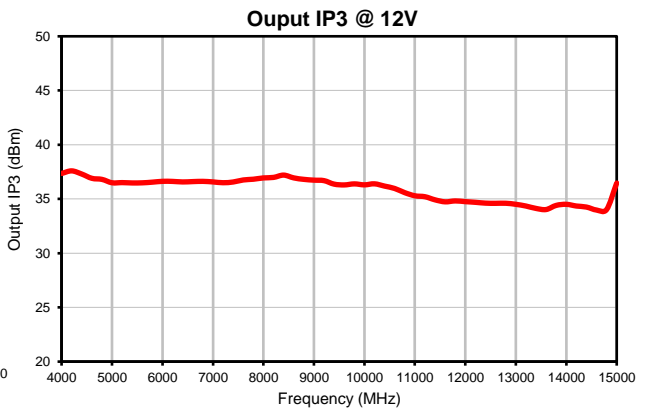
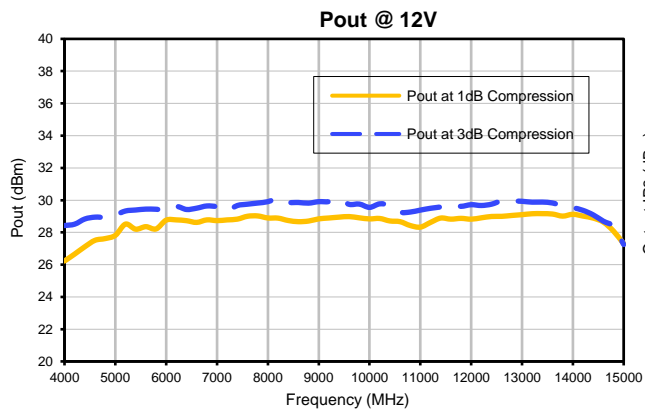
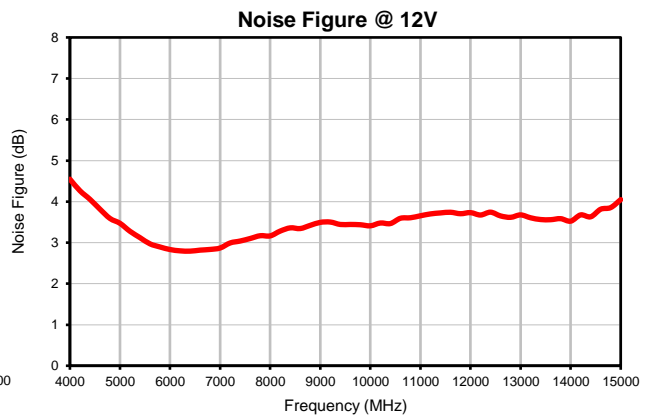
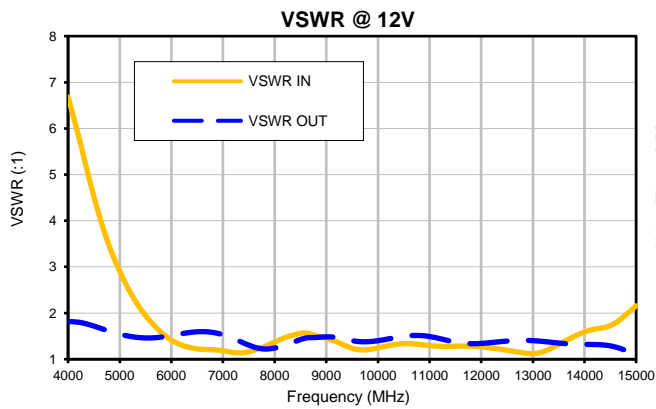
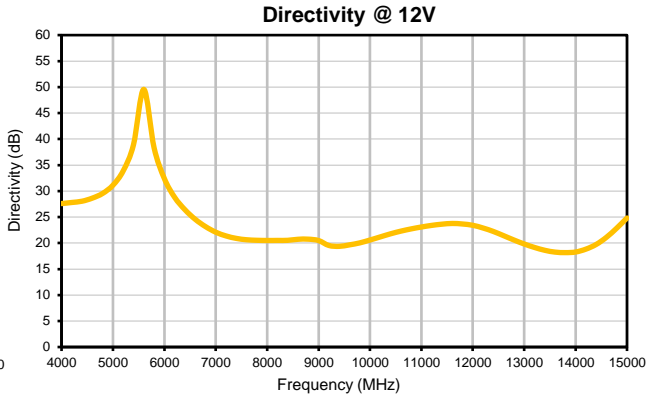
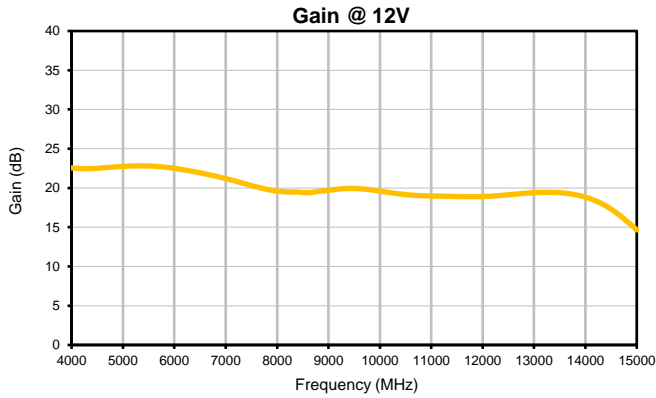

Outline Dimensions

AV243

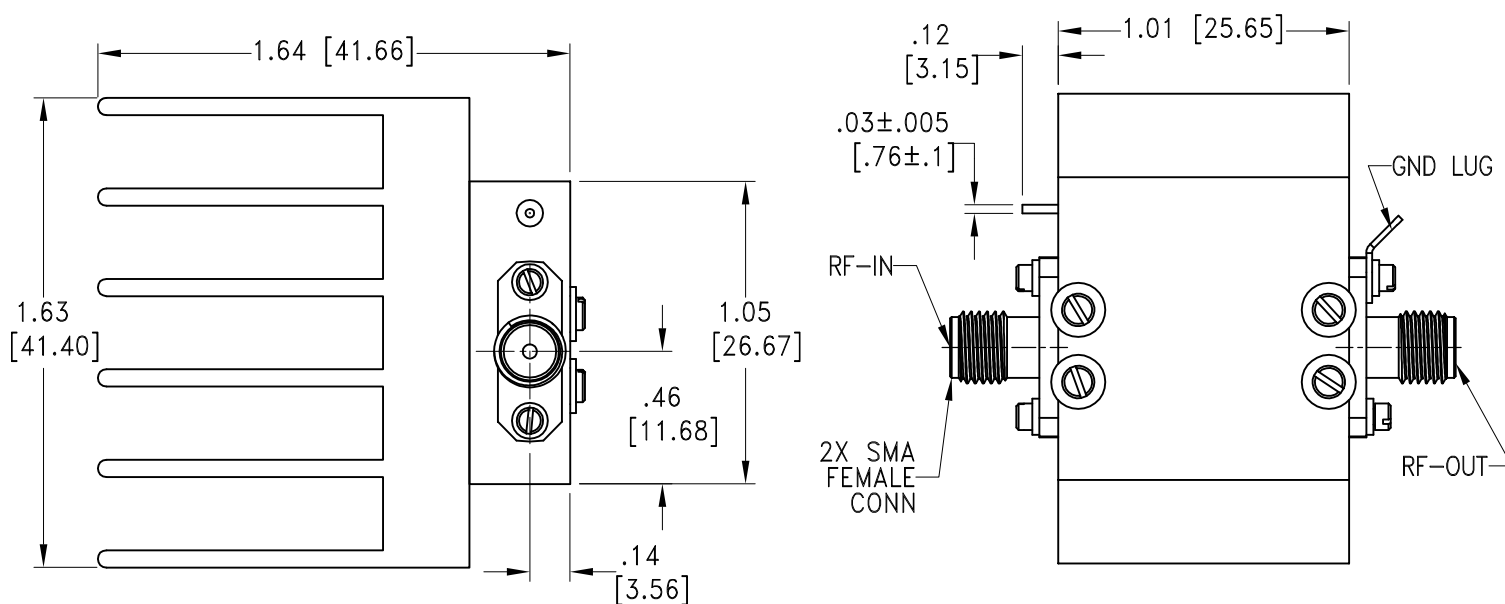

MOUNTING INFORMATION OF MODEL WITHOUT HEATSINK

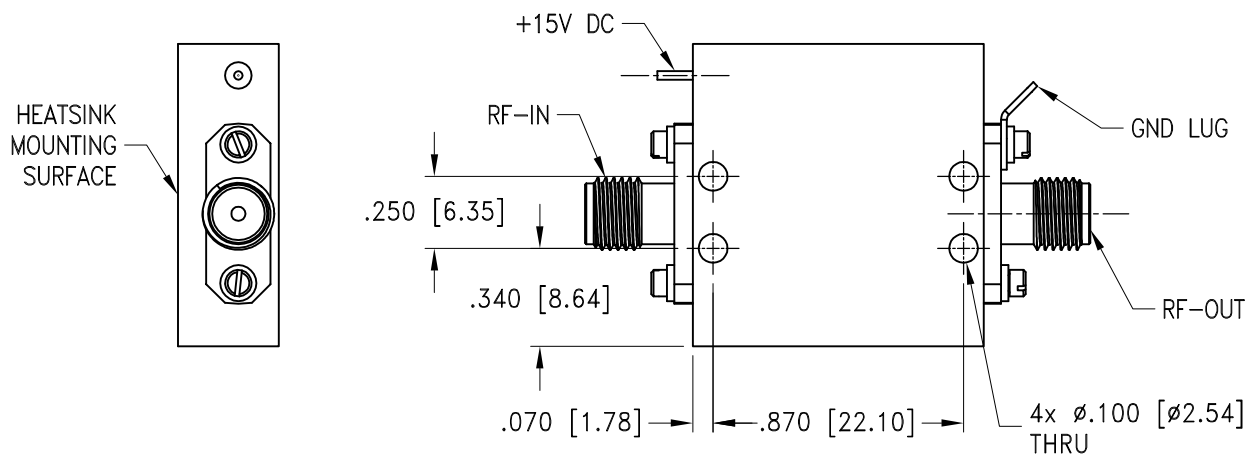

Weight: 58 grams; Weight without heatsink: 17 grams

Dimensions are in inches (mm). Tolerances: 2 Pl.±.03; 3 Pl. ±.015

Notes:

1. Case material: Aluminum alloy
2. Case finish: Nickel plate.
3. Heat sink finish: Black anodize.

Mini-Circuits
ISO 9001 ISO 14001 CERTIFIED

ALL NEW
minicircuits.com

P.O. Box 350166, Brooklyn, New York 11235-0003 (718) 934-4500 Fax (718) 332-4661 For detailed performance specs & shopping online see Mini-Circuits web site



The Design Engineers Search Engine Provides ACTUAL Data Instantly From MINI-CIRCUITS At: www.minicircuits.com

RF/IF MICROWAVE COMPONENTS



All Mini-Circuits products are manufactured under exacting quality assurance and control standards, and are capable of meeting published specifications after being subjected to any or all of the following physical and environmental test.

Specification	Test/Inspection Condition	Reference/Spec
Operating Temperature	-55° to 54° C Ambient Environment	Individual Model Data Sheet
Storage Temperature	-55° to 100° C Ambient Environment	Individual Model Data Sheet
Stabilization Bake	(non-operating) 125°C, 24 hours	- - -
Burn-in at Elevated Temp.	(DC on) 160 hours at 85° C	MIL-STD-202, Method 108
Thermal Shock	-55° to 100°C, 5 cycles	MIL-STD-202, Method 107, Condition A, except 100°C