

Cavity Bandpass Filters

ZVBP Model Series

50Ω 24.25 to 43.5 GHz

The Big Deal

- Very low insertion loss with excellent power handling
- Sharp roll-off with wide stopband
- Passbands from 24.25 to 43.5 GHz covering 5G bands*.
- Stopbands up to 57 GHz



Product Overview

Mini-Circuits' cavity filters are designed by implementing resonant structures with very high Q and are ideal for narrow-band, high-selectivity applications. These designs can provide bandwidths as narrow as 3% with very high selectivity and excellent low noise floor. Low insertion loss combined with excellent power handling makes them well-suited for transmitter and receiver front end. Advanced filter design and construction enables stopband width greater than 3x the center frequency.

Key Features

Feature	Advantages
5G bands	Use in various 5G applications, covering n257, n258, n259, n260, and n261 bands.
Low insertion loss	Low signal loss results in better SNR in receiver front end and better power delivery to antenna in transmitter
Sharp roll-off	Higher selectivity results in better adjacent channel rejection and dynamic range
Wide stopband	Wide spur free band results in better receiver sensitivity
High power handling	Well suited for transmitter application
Protective assembly	Prevents accidental de-tuning of precisely tuned resonant circuit

*High frequency models operating above 40 GHz are available with 2.4mm connectors.

Cavity Bandpass Filter

ZVBP-40600-K+

50Ω 37700 to 43500 MHz



Generic photo used for illustration purposes only

CASE STYLE: UH3130

Connectors	Model
2.92mm-F	ZVBP-40600-K+

Features

- Low insertion loss, 1.3 dB typical
- Good return loss, 21 dB typical
- High rejection
- Broad stopband performance up to 57 GHz
- Sharp roll-off
- Also available with 2.4mm connectors (model ZVBP-40600-V+)

Applications

- 5G bands n259 and n260

Electrical Specifications¹ at 25°C

Parameter	F#	Frequency (MHz)	Min.	Typ.	Max.	Unit
Pass Band	Center Frequency	-	-	40600	-	MHz
	Insertion Loss	F1-F2	37700 - 43500	-	1.3	dB
	Return Loss	F1-F2	37700 - 43500	15	28	dB
Stop Band, Lower	Insertion Loss	DC-F3	DC - 36600	80	125	dB
	Return Loss	DC-F3	DC - 36600	-	0.21	dB
Stop Band, Upper	Insertion Loss	F4-F5	44600 - 57000	80	114	dB
	Return Loss	F4-F5	44600 - 57000	-	0.58	dB

1.Data measured after calibrating using 2.92mm cal kit.

Simplified Functional Schematic

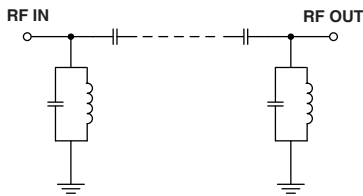

Maximum Ratings

Operating Temperature	-30°C to 70°C
Storage Temperature	-30°C to 70°C
RF Power Input	2.5 W

Permanent damage may occur if any of these limits are exceeded.

Typical Performance Data at 25°C

Frequency (MHz)	Insertion Loss (dB)	Return Loss (dB)	Frequency (MHz)	Group Delay (nsec)
10	90.06	0.01	37700	2.62
1000	122.97	0.08	38000	1.83
10000	123.19	0.16	38300	1.54
20000	121.50	0.28	38600	1.38
30000	117.15	0.06	38900	1.27
36600	102.24	0.56	39200	1.19
37200	64.67	0.57	39500	1.15
37700	2.20	21.19	39800	1.11
38000	1.54	25.61	40100	1.07
39000	1.12	35.12	40400	1.05
40000	1.04	27.80	40600	1.05
40600	1.06	30.93	40800	1.03
41000	0.92	34.38	41100	1.03
42000	1.13	22.76	41400	1.06
43000	1.37	30.75	41700	1.07
43500	1.90	24.39	42000	1.11
44000	33.92	1.11	42300	1.16
44600	84.54	0.22	42600	1.22
50000	115.14	0.67	42900	1.32
57000	117.01	1.82	43500	1.95

Typical Frequency Response

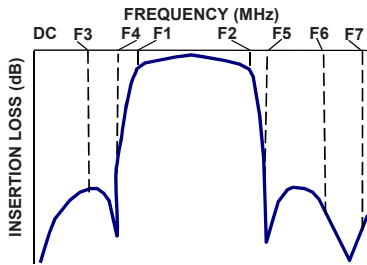

+RoHS Compliant

The +Suffix identifies RoHS Compliance. See our web site for RoHS Compliance methodologies and qualifications

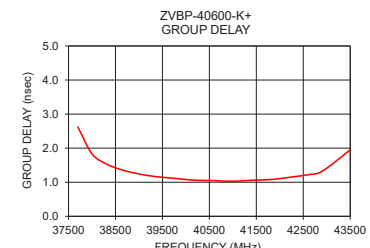
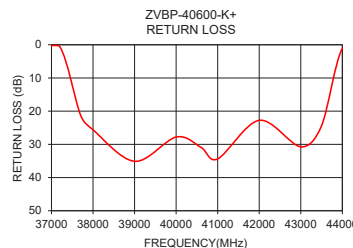
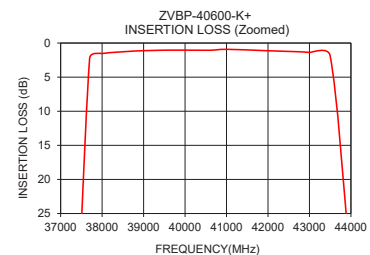
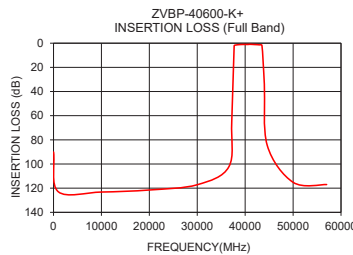

Coaxial Connections

PORT 1	2.92mm-FEMALE
PORT 2	2.92mm-FEMALE

Outline Drawing

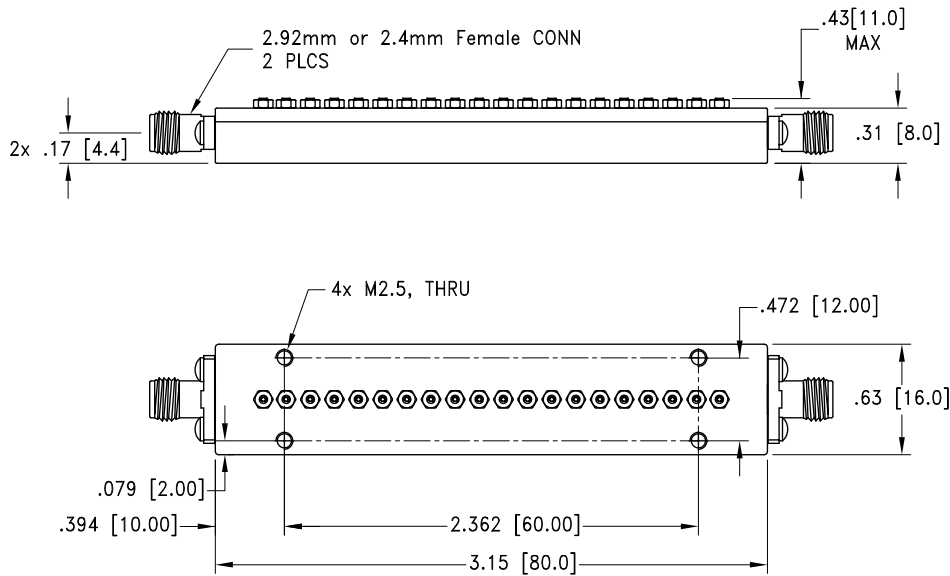

Weight: 77.5 grams \pm 5 grams;
Dimensions are in inches [mm]. Tolerances: 2 Pl. \pm .03; 3 Pl. \pm .015

Additional Notes

- Performance and quality attributes and conditions not expressly stated in this specification document are intended to be excluded and do not form a part of this specification document.
- Electrical specifications and performance data contained in this specification document are based on Mini-Circuit's applicable established test performance criteria and measurement instructions.
- The parts covered by this specification document are subject to Mini-Circuits standard limited warranty and terms and conditions (collectively, "Standard Terms"); Purchasers of this part are entitled to the rights and benefits contained therein. For a full statement of the Standard Terms and the exclusive rights and remedies thereunder, please visit Mini-Circuits' website at www.minicircuits.com/MCLStore/terms.jsp

Cavity Band Pass Filter

ZVBP-40600-K+

Typical Performance Data

FREQUENCY (MHz)	INSERTION LOSS (dB)	INPUT RETURN LOSS (dB)	OUTPUT RETURN LOSS (dB)	FREQUENCY (MHz)	Group Delay (ns)
10	90.06	0.01	0.01	37700	2.62
100	115.97	0.03	0.03	38000	1.83
1000	122.97	0.10	0.08	38300	1.54
2000	124.07	0.13	0.10	38600	1.38
4000	129.84	0.10	0.08	38900	1.27
6000	133.83	0.07	0.05	39200	1.19
8000	132.72	0.11	0.10	39500	1.15
10000	123.19	0.16	0.16	39800	1.11
12000	121.35	0.15	0.16	40100	1.07
14000	128.17	0.12	0.14	40400	1.05
16000	120.85	0.19	0.20	40600	1.05
18000	136.28	0.31	0.29	40800	1.03
20000	121.50	0.32	0.28	41100	1.03
22000	124.47	0.21	0.20	41400	1.06
24000	125.25	0.20	0.19	41700	1.07
28000	122.64	0.19	0.21	42000	1.11
32000	118.51	0.16	0.19	42300	1.16
36000	110.79	0.65	0.59	42600	1.22
36600	102.24	0.60	0.56	42900	1.32
37200	64.67	0.57	0.58	43500	1.95
37700	2.20	21.19	21.90		
38000	1.54	25.61	27.03		
39000	1.12	35.52	35.12		
40000	1.04	28.28	27.80		
40600	1.06	30.93	33.69		
41000	0.92	34.38	50.02		
42000	1.13	23.00	22.76		
43000	1.37	30.75	33.97		
43500	1.90	24.39	38.17		
44000	33.92	1.11	1.13		
45000	109.03	0.16	0.11		
46000	117.37	0.17	0.12		
47000	117.91	0.24	0.22		
48000	119.65	0.33	0.34		
49000	117.87	0.48	0.53		
50000	115.14	0.67	0.71		
51000	128.14	0.85	0.83		
53000	119.06	0.82	0.80		
55000	117.60	0.05	0.03		
57000	117.01	1.82	1.86		



Typical Performance Curves

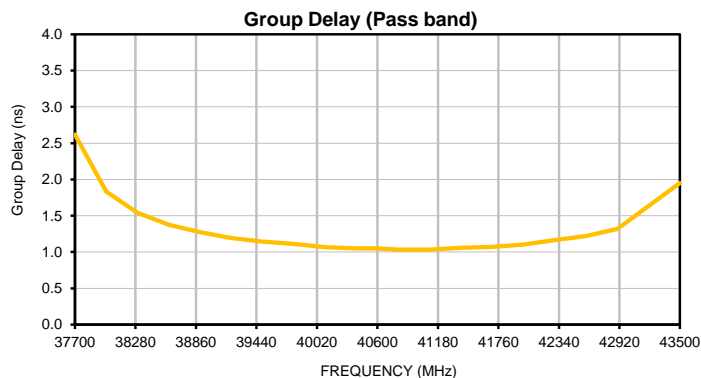
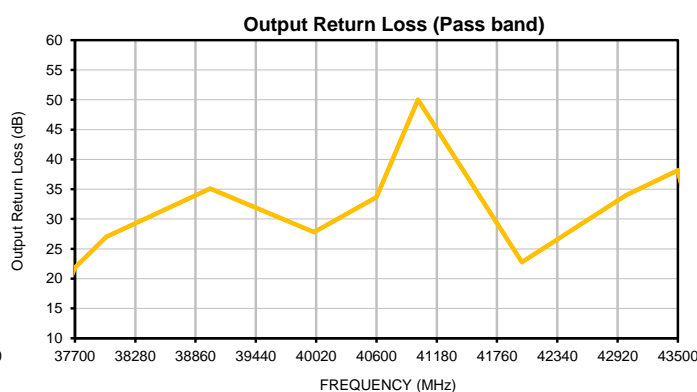
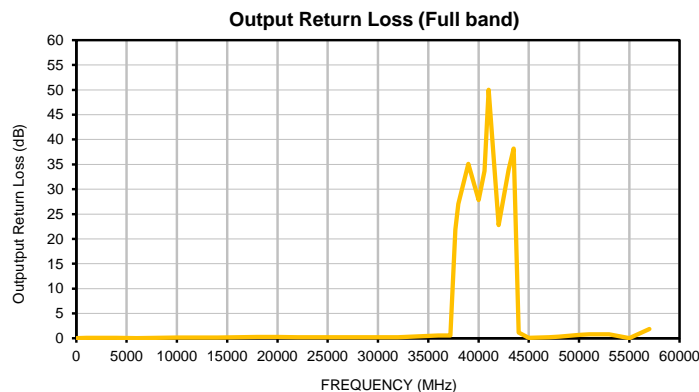
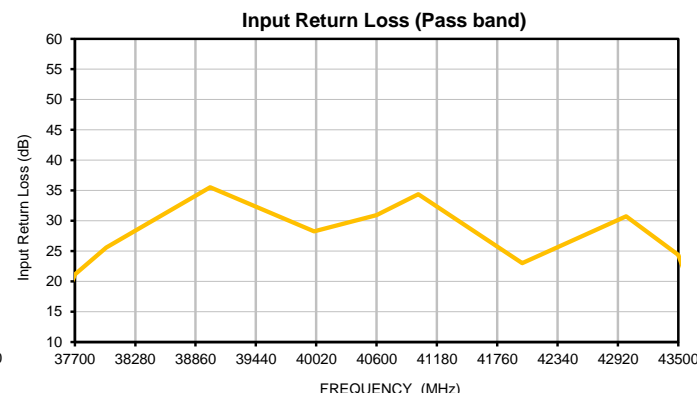
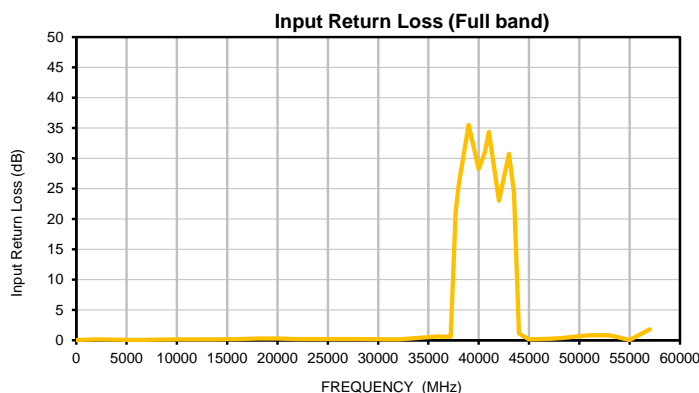
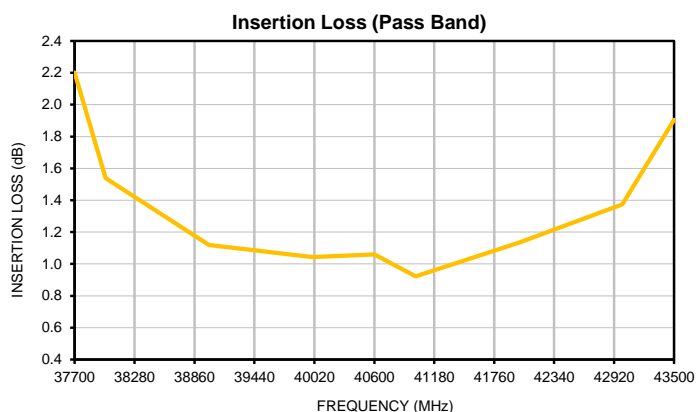

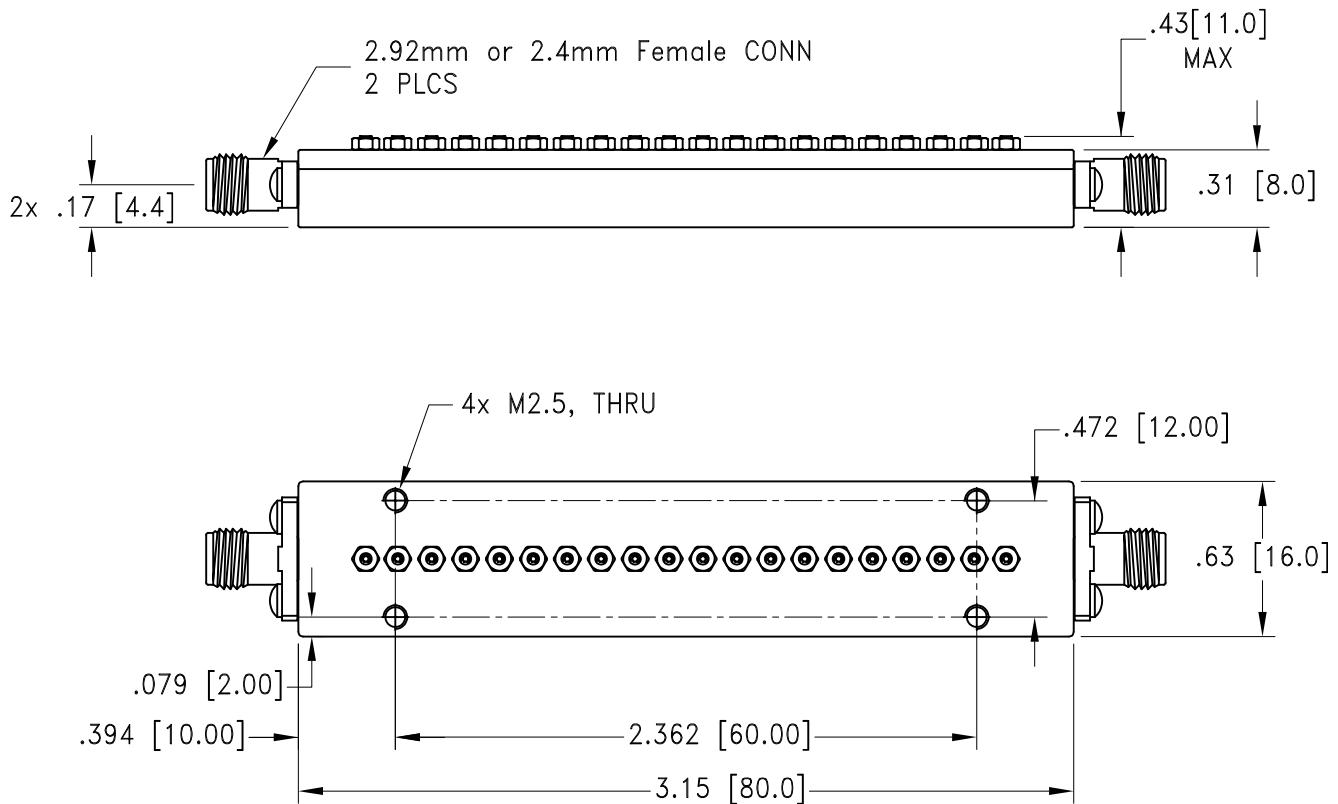

Weight: 77.5 grams \pm 5 grams;

Dimensions are in inches (mm). Tolerances: 2 Pl. \pm .03; 3 Pl. \pm .015

Notes:

1. Case material: H62 Copper Alloy
2. Case Finish: Black Painting



P.O. Box 350166, Brooklyn, New York 11235-0003 (718) 934-4500 Fax (718) 332-4661 For detailed performance specs & shopping online see Mini-Circuits web site



The Design Engineers Search Engine Provides ACTUAL Data Instantly From MINI-CIRCUITS At: www.minicircuits.com

RF/IF MICROWAVE COMPONENTS



Environmental Specifications ENV77T1

All Mini-Circuits products are manufactured under exacting quality assurance and control standards, and are capable of meeting published specifications after being subjected to any or all of the following physical and environmental test.

Specification	Test/Inspection Condition	Reference/Spec
Operating Temperature	-30° to 70°C Ambient Environment	Individual Model Data Sheet
Storage Temperature	-30° to 70° C Ambient Environment	Individual Model Data Sheet
Thermal Shock	-55° to 100°C, 100 cycles	MIL-STD-202, Method 107, Condition A-3, except +100°C