

Cavity Bandpass Filters

50Ω DC to 40 GHz

The Big Deal

- Very low insertion loss with excellent power handling
- Very fast roll-off with wide stopband
- Passbands up to 36 GHz
- Stopbands up to 40 GHz



Product Overview

Mini-Circuits' cavity filters are designed by implementing resonant structures with very high Q and are ideal for narrow-band, high-selectivity applications. These designs can provide bandwidths as narrow as 1% with very high selectivity and excellent low noise floor. Low insertion loss combined with excellent power handling makes them well-suited for transmitter and receiver front end. Advanced filter design and construction enables stopband width greater than 3x the center frequency.

Mini-Circuits' cavity filters feature a special protective assembly to prevent accidental de-tuning that would otherwise require expensive replacement or return to factory for re-tuning. Custom integrated assembly with LNA and bias tees results in greatly simplifying system integration. Precise machining allows realization of cavity filters with small form factors for applications where size is critical. Excellent repeatability across units is achieved through precise tuning and process control.

Key Features

Feature	Advantages
Low insertion loss	Low signal loss results in better SNR in receiver front end and better power delivery to antenna in transmitter
Fast roll-off	Higher selectivity results in better adjacent channel rejection and dynamic range
Wide stopband	Wide spur free band results in better receiver sensitivity
High power handling	Well suited for transmitter application
Protective assembly	Prevents accidental de-tuning of precisely tuned resonant circuit

Notes

- A. Performance and quality attributes and conditions not expressly stated in this specification document are intended to be excluded and do not form a part of this specification document.
B. Electrical specifications and performance data contained in this specification document are based on Mini-Circuit's applicable established test performance criteria and measurement instructions.
C. The parts covered by this specification document are subject to Mini-Circuits standard limited warranty and terms and conditions (collectively, "Standard Terms"); Purchasers of this part are entitled to the rights and benefits contained therein. For a full statement of the Standard Terms and the exclusive rights and remedies thereunder, please visit Mini-Circuits' website at www.minicircuits.com/MCLStore/terms.jsp



Bandpass Filter

50Ω 9750 to 11250 MHz

ZVBP-10R5G-S+



Generic photo used for illustration purposes only

CASE STYLE: PV2184

Connectors Model
SMA-F ZVBP-10R5G-S+

Features

- Low insertion loss, <0.5 dB typical
- Broad Stopband performance up to 18GHz
- Fast roll-off
- Connectorized package
- Small size

Applications

- Satellite
- Radar

Electrical Specifications at 25°C

Parameter	F#	Frequency (MHz)	Min.	Typ.	Max.	Unit	
Pass Band	Center Frequency	-	-	10500	-	MHz	
	Insertion Loss	F1-F2	9750-11250	-	0.5	dB	
	VSWR	F1-F2	9750-11250	-	1.3	1.5	:1
Stop Band, Lower	Insertion Loss	DC-F3	DC - 5950	40	51	-	dB
	VSWR	DC-F3	DC - 5950	-	40	-	:1
Stop Band, Upper	Insertion Loss	F4-F5	15100-18000	40	45	-	dB
	VSWR	F4-F5	15100-18000	-	7	-	:1

Maximum Ratings

Operating Temperature	-40°C to 85°C
Storage Temperature	-55°C to 100°C
RF Power Input	1 W max.

Permanent damage may occur if any of these limits are exceeded.

Functional Schematic

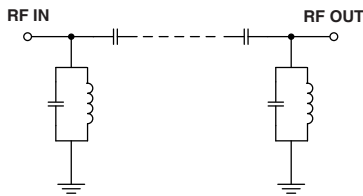

Typical Frequency Response

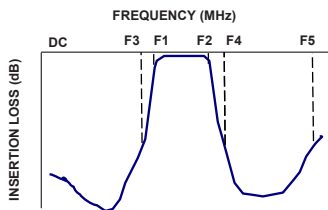

Typical Performance Data at 25°C

Frequency (MHz)	Insertion Loss (dB)	VSWR (:1)	Frequency (MHz)	Group Delay (nsec)
100	95.44	1737.18	9750	0.70
500	83.67	173.72	9800	0.68
3000	68.15	248.17	9850	0.66
5950	52.31	96.51	9900	0.64
8200	30.29	91.43	9950	0.61
8800	19.24	75.53	10000	0.60
9400	3.44	5.68	10100	0.57
9450	2.36	4.01	10250	0.54
9750	0.24	1.05	10300	0.54
10500	0.24	1.15	10400	0.53
11250	0.24	1.08	10500	0.53
11650	2.30	3.82	10600	0.52
11700	3.21	5.13	10750	0.53
12500	20.49	75.53	10900	0.54
13200	30.26	102.19	11000	0.55
15100	45.64	72.39	11050	0.56
16000	49.94	62.05	11100	0.57
17000	52.87	57.91	11150	0.58
17500	53.59	57.91	11200	0.59
18000	53.52	54.29	11250	0.61

+RoHS Compliant

The +Suffix identifies RoHS Compliance. See our web site for RoHS Compliance methodologies and qualifications

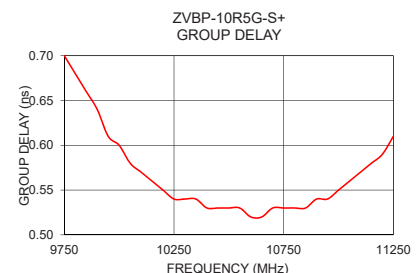
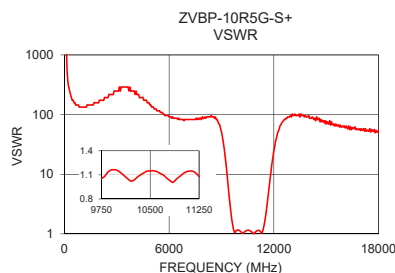
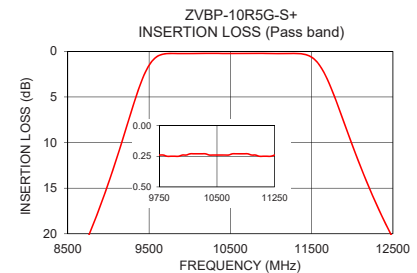
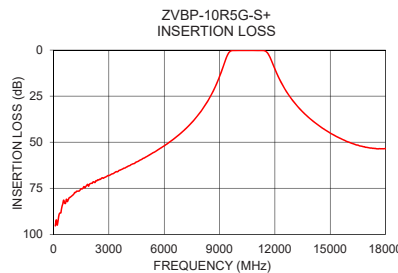

Notes

- Performance and quality attributes and conditions not expressly stated in this specification document are intended to be excluded and do not form a part of this specification document.
- Electrical specifications and performance data contained in this specification document are based on Mini-Circuits' applicable established test performance criteria and measurement instructions.
- The parts covered by this specification document are subject to Mini-Circuits standard limited warranty and terms and conditions (collectively, "Standard Terms"); Purchasers of this part are entitled to the rights and benefits contained therein. For a full statement of the Standard Terms and the exclusive rights and remedies thereunder, please visit Mini-Circuits' website at www.minicircuits.com/MCLStore/terms.jsp



Coaxial Connections

PORT - 1	SMA-FEMALE
PORT - 2	SMA-FEMALE

Outline Drawing

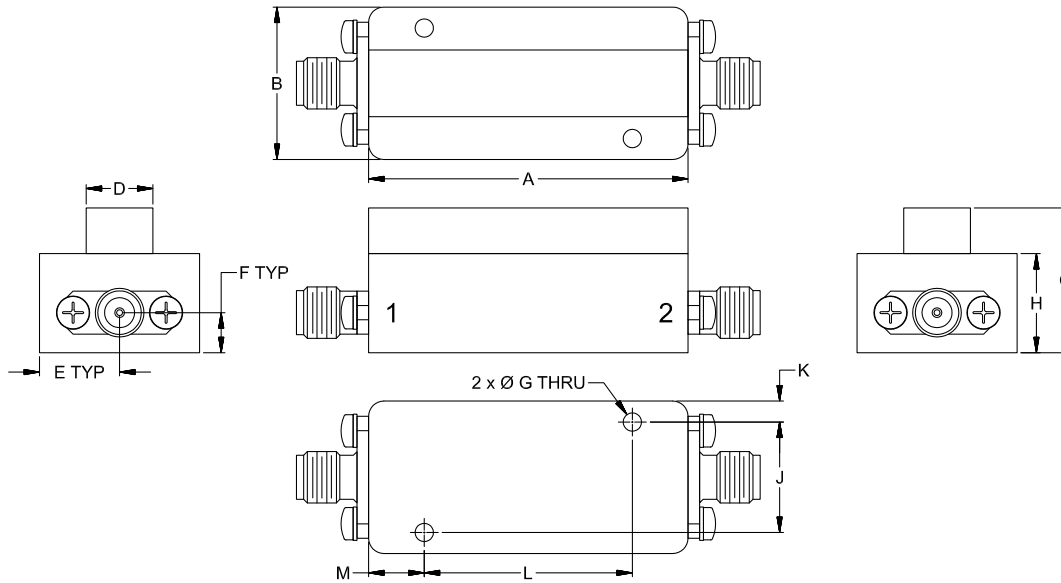

Outline Dimensions ($\frac{\text{inch}}{\text{mm}}$)

A	B	C	D	E	F	G
1.65	.79	.75	.34	.39	.21	.095
41.92	20.00	19.00	8.75	10.00	5.25	2.40
H	J	K	L	M	Wt.	
.51	.571	.11	1.075	.29	grams	
13.00	14.50	2.75	27.31	7.31	78	

Note: Please refer to case style drawing for details

Notes

- A. Performance and quality attributes and conditions not expressly stated in this specification document are intended to be excluded and do not form a part of this specification document.
- B. Electrical specifications and performance data contained in this specification document are based on Mini-Circuit's applicable established test performance criteria and measurement instructions.
- C. The parts covered by this specification document are subject to Mini-Circuits standard limited warranty and terms and conditions (collectively, "Standard Terms"); Purchasers of this part are entitled to the rights and benefits contained therein. For a full statement of the Standard Terms and the exclusive rights and remedies thereunder, please visit Mini-Circuits' website at www.minicircuits.com/MCLStore/terms.jsp



Typical Performance Data

FREQ. (MHz)	INSERTION LOSS			INPUT RETURN LOSS			OUTPUT RETURN LOSS		
	(dB)			(dB)			(dB)		
	@-40°C	@+25°C	@+85°C	@-40°C	@+25°C	@+85°C	@-40°C	@+25°C	@+85°C
100	88.27	95.44	93.09	0.01	0.01	0.01	0.00	0.00	0.00
450	89.62	85.28	85.14	0.08	0.10	0.09	0.07	0.08	0.07
850	81.16	80.22	79.73	0.10	0.13	0.13	0.08	0.11	0.11
1650	74.18	74.14	74.28	0.06	0.12	0.12	0.06	0.11	0.12
4050	62.99	62.99	63.16	0.04	0.08	0.13	0.05	0.08	0.14
5850	52.97	53.01	53.05	0.06	0.18	0.21	0.02	0.15	0.20
5950	52.34	52.31	52.43	0.06	0.18	0.20	0.02	0.15	0.20
7150	42.82	42.86	42.85	0.09	0.21	0.20	0.04	0.16	0.18
8100	31.62	31.77	31.71	0.06	0.20	0.20	0.00	0.15	0.16
8300	28.63	28.72	28.65	0.03	0.19	0.20	0.02	0.14	0.16
8500	25.30	25.29	25.20	0.02	0.19	0.18	0.02	0.15	0.17
8650	22.51	22.43	22.28	0.01	0.19	0.21	0.02	0.15	0.19
8700	21.50	21.39	21.21	0.03	0.21	0.23	0.02	0.16	0.20
9150	10.72	10.36	9.99	0.36	0.63	0.74	0.33	0.59	0.73
9250	7.84	7.49	7.12	0.79	1.11	1.28	0.74	1.08	1.30
9300	6.38	6.06	5.70	1.15	1.53	1.81	1.11	1.51	1.80
9350	4.94	4.68	4.37	1.73	2.18	2.50	1.68	2.15	2.53
9500	1.54	1.53	1.44	5.51	6.28	6.88	5.47	6.26	6.96
9550	0.85	0.94	0.92	7.91	8.73	9.47	7.90	8.75	9.52
9650	0.17	0.37	0.43	16.33	16.33	16.64	16.43	16.48	16.86
9700	0.07	0.27	0.34	24.46	22.64	22.70	24.97	22.94	22.49
9750	0.05	0.24	0.31	29.00	31.73	30.03	31.30	32.87	28.91
9800	0.06	0.24	0.30	22.75	28.09	36.43	22.91	27.81	30.41
9850	0.08	0.25	0.30	19.73	23.99	28.55	19.85	23.79	26.89
9900	0.10	0.25	0.30	18.58	22.55	28.58	18.62	22.35	26.17
10000	0.09	0.25	0.30	19.07	22.90	29.19	19.07	22.61	27.03
10100	0.05	0.24	0.29	23.36	27.30	38.33	23.08	26.37	31.24
10150	0.04	0.23	0.29	27.17	31.35	39.42	26.29	29.27	31.32
10200	0.04	0.23	0.29	35.40	38.74	33.78	30.06	31.41	29.66
10300	0.04	0.23	0.29	27.67	29.41	26.50	25.99	27.33	25.64
10400	0.06	0.24	0.29	21.97	24.72	24.71	21.35	23.79	24.29
10450	0.07	0.24	0.29	19.93	23.32	25.03	19.66	22.64	24.24
10500	0.08	0.24	0.29	19.08	23.16	26.02	18.79	22.52	25.31
10600	0.08	0.24	0.28	18.32	23.60	30.24	18.24	23.16	28.90
10700	0.07	0.23	0.28	19.92	26.55	41.89	19.92	25.99	37.99
10750	0.05	0.23	0.28	22.00	30.17	34.39	21.83	29.34	37.36
10800	0.04	0.23	0.29	24.80	36.56	31.48	24.78	34.71	31.54
10850	0.03	0.23	0.30	28.69	49.04	26.21	28.77	40.58	26.78
10900	0.02	0.23	0.30	40.21	33.00	24.03	36.91	32.21	24.28
11050	0.05	0.25	0.32	24.59	23.85	21.07	23.56	23.46	20.95
11200	0.07	0.25	0.31	21.39	24.75	24.59	20.73	24.11	24.34
11250	0.06	0.24	0.29	22.49	28.36	28.87	21.90	27.45	29.64
11300	0.05	0.24	0.30	25.25	37.76	32.24	24.55	38.50	37.08
11400	0.05	0.31	0.42	26.53	19.57	16.74	27.20	19.98	16.94
11450	0.12	0.43	0.60	18.04	14.68	12.51	18.25	14.87	12.74
11500	0.28	0.65	0.90	13.12	11.15	9.71	13.12	11.21	9.73
11600	1.07	1.57	1.97	7.01	6.27	5.45	6.93	6.25	5.50
11650	1.77	2.30	2.74	5.07	4.66	4.12	4.93	4.60	4.12
11800	4.94	5.40	5.85	1.84	1.90	1.72	1.69	1.80	1.72
12100	12.45	12.59	12.71	0.32	0.48	0.42	0.16	0.35	0.41
12300	16.75	16.81	16.78	0.13	0.31	0.25	0.03	0.16	0.21
12350	17.74	17.78	17.73	0.10	0.27	0.20	0.05	0.13	0.18
12800	24.86	25.14	25.02	0.02	0.19	0.12	0.14	0.03	0.07
13000	27.40	27.85	27.78	0.00	0.19	0.16	0.17	0.01	0.06
13350	31.26	31.94	32.06	0.03	0.18	0.14	0.17	0.01	0.05
14050	37.50	38.44	38.95	0.01	0.20	0.13	0.16	0.03	0.07
15100	45.57	45.64	46.14	0.01	0.24	0.19	0.12	0.07	0.13
15200	46.22	46.15	46.64	0.03	0.22	0.20	0.13	0.06	0.13
17500	54.31	53.59	52.43	0.04	0.30	0.31	0.08	0.16	0.27
18000	53.85	53.52	52.52	0.06	0.32	0.32	0.09	0.18	0.30

Typical Performance Data

FREQ. (MHz)	GROUP DELAY		
	(nsec)		
	@-40°C	@+25°C	@+85°C
9750	0.72	0.70	0.69
9800	0.70	0.68	0.67
9850	0.68	0.66	0.64
9900	0.65	0.64	0.62
9950	0.63	0.61	0.60
10000	0.61	0.60	0.58
10050	0.60	0.58	0.57
10100	0.58	0.57	0.56
10150	0.57	0.56	0.55
10200	0.56	0.55	0.54
10250	0.56	0.54	0.54
10300	0.55	0.54	0.53
10350	0.55	0.54	0.53
10400	0.54	0.53	0.52
10450	0.54	0.53	0.52
10500	0.54	0.53	0.52
10550	0.54	0.53	0.52
10600	0.54	0.52	0.52
10650	0.54	0.52	0.52
10700	0.54	0.53	0.52
10750	0.54	0.53	0.52
10800	0.54	0.53	0.52
10850	0.54	0.53	0.52
10900	0.55	0.54	0.53
10950	0.55	0.54	0.53
11000	0.56	0.55	0.54
11050	0.56	0.56	0.55
11100	0.57	0.57	0.56
11150	0.59	0.58	0.57
11200	0.60	0.59	0.59
11250	0.62	0.61	0.61

Typical Performance Curves

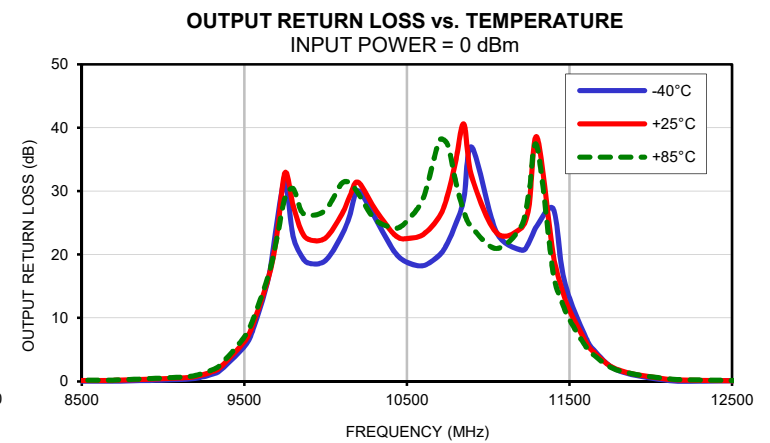
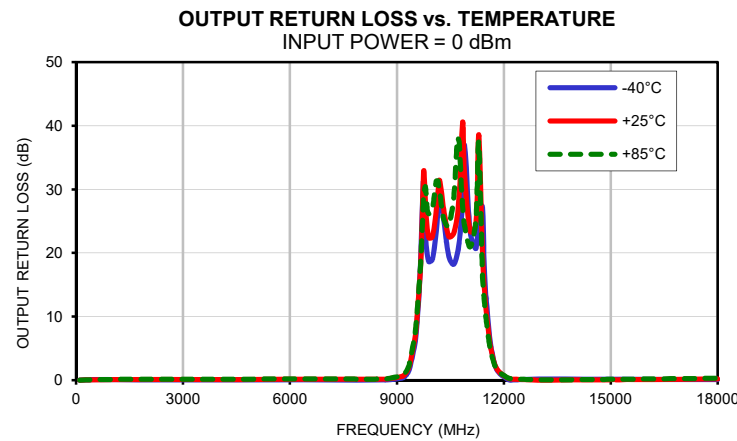
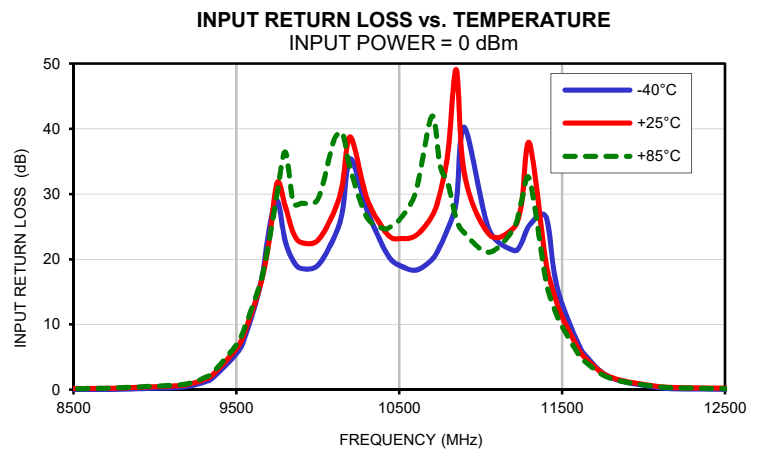
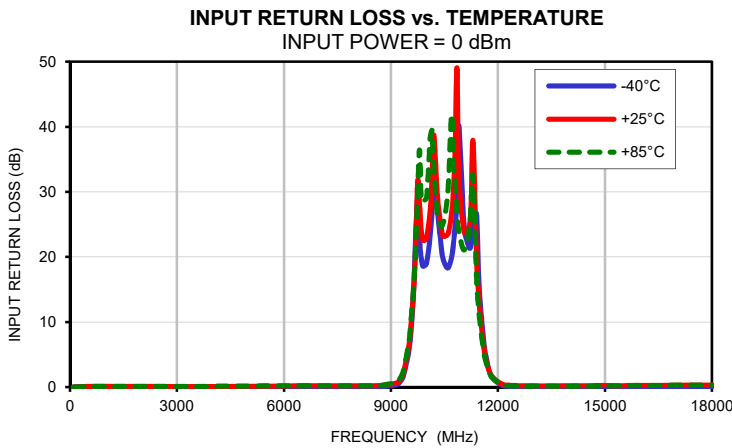
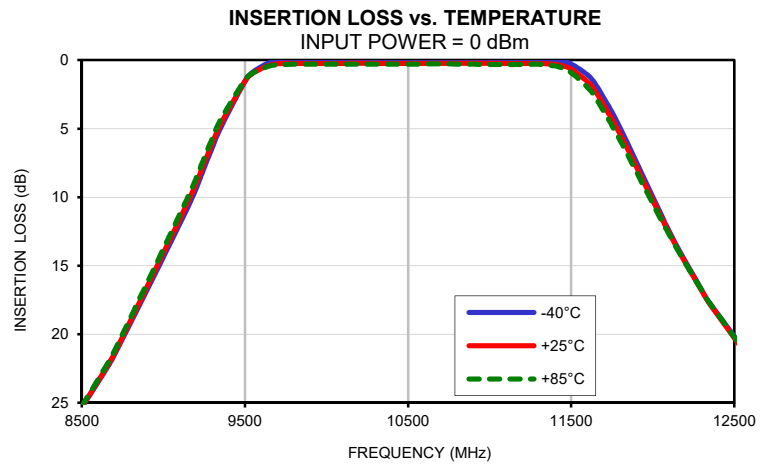
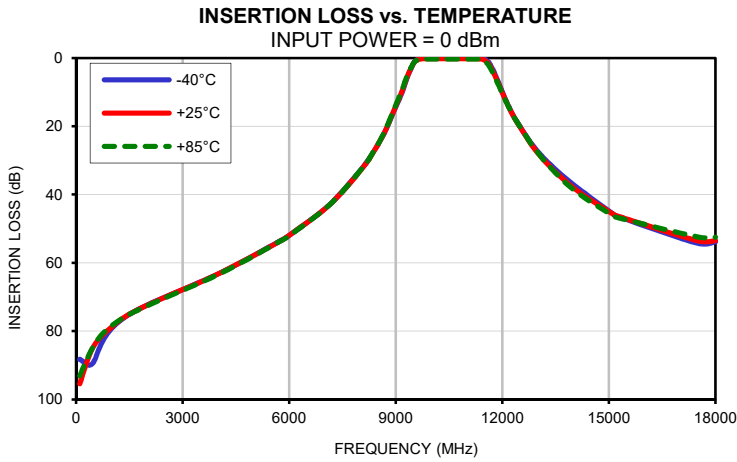

Typical Performance Curves

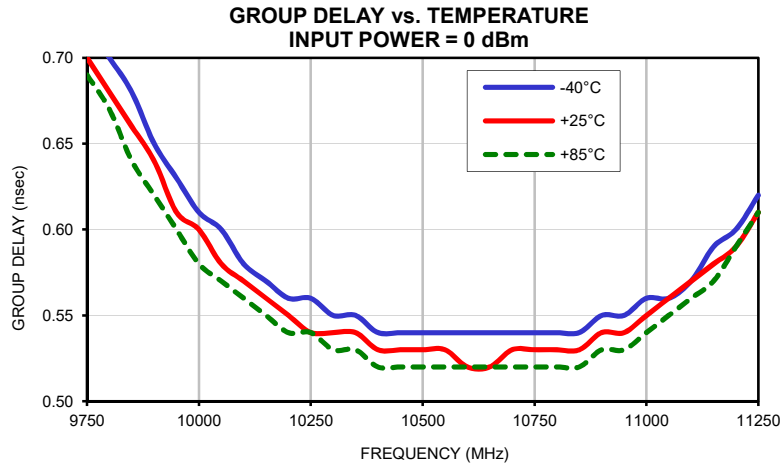

Outline Dimensions

PV2184

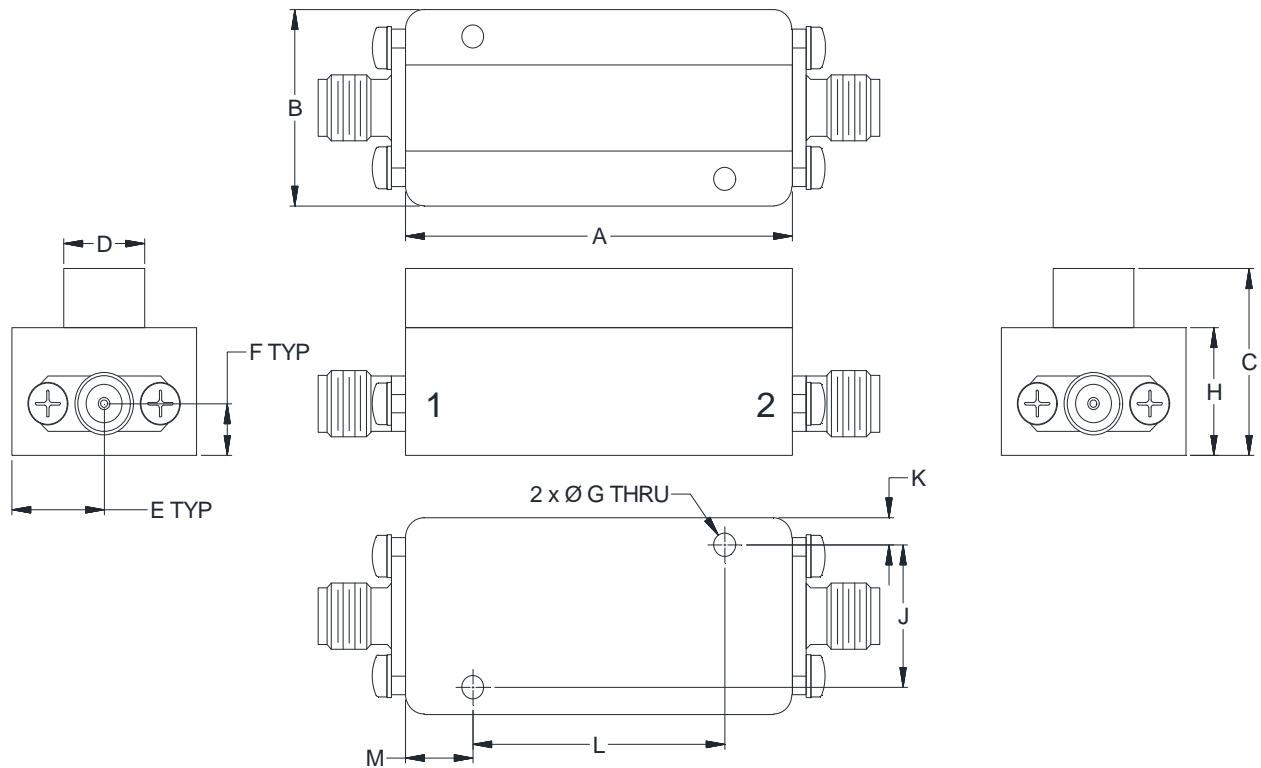

CASE#	A	B	C	D	E	F	G	H	J
PV2184	1.65 (41.92)	.79 (20.00)	.75 (19.00)	.34 (8.75)	.39 (10.00)	.21 (5.25)	.095 (2.40)	.51 (13.00)	.571 (14.50)

CASE#	K	L	M	WT. GRAMS
PV2184	.11 (2.75)	1.075 (27.31)	.29 (7.31)	78

Dimensions are in inches (mm). Tolerances: 2 Pl. $\pm .03$; 3 Pl. $\pm .015$

Notes:

1. Case material: Brass & Aluminum alloy.
2. Case finish: Powder coated.
3. Refer to the individual model data sheet for the type of connectors available.

Mini-Circuits®
ISO 9001 ISO 14001 CERTIFIED

ALL NEW
minicircuits.com

P.O. Box 350166, Brooklyn, New York 11235-0003 (718) 934-4500 Fax (718) 332-4661 For detailed performance specs & shopping online see Mini-Circuits web site



The Design Engineers Search Engine Provides ACTUAL Data Instantly From MINI-CIRCUITS At: www.minicircuits.com

RF/IF MICROWAVE COMPONENTS

All Mini-Circuits products are manufactured under exacting quality assurance and control standards, and are capable of meeting published specifications after being subjected to any or all of the following physical and environmental test.

Specification	Test/Inspection Condition	Reference/Spec
Operating Temperature	-55° to 100°C Ambient Environment	Individual Model Data Sheet
Storage Temperature	-55° to 100° C Ambient Environment	Individual Model Data Sheet
Humidity	90 to 95% RH, 40°C, 96 hours; Units may require bake-out after humidity to restore full performance.	MIL-STD-202, Method 103, Condition B
Thermal Shock	-55° to 100°C, 100 cycles	MIL-STD-202, Method 107, Condition A-3, except +100°C
Vibration (High Frequency)	20g peak, 10-2000 Hz, 12 times in each of three perpendicular directions (total 36)	MIL-STD-202, Method 204, Condition D
Mechanical Shock	50g, 11ms half-sine, 3 shocks each direction 3 axes (total 18)	MIL-STD-202, Method 213, Condition A