



LOW NOISE, HIGH GAIN

Wideband Amplifier

ZVA-24443G1+ ZVA-24443G1X+

50Ω 24 to 43.5 GHz¹

THE BIG DEAL

- Extremely Low Noise Figure of 1.7 dB typ. through Q-Band
- High Gain of 45 dB typ., over 5G bands – 24 to 39 GHz
- Available with and without heatsink
- Operates with a single DC supply of +9 to +15 V
- Over-Voltage and Reverse Voltage protected



Generic photo used for illustration purposes only

Model No.	ZVA-24443G1+	ZVA-24443G1X+▲
Case Style	T2704	
Connectors	2.92mm Female	

+RoHS Compliant

The +Suffix identifies RoHS Compliance. See our web site for RoHS Compliance methodologies and qualifications

APPLICATIONS

- 5G (24-39 GHz)
- Q-Band SATCOM
- Test and Instrumentation

PRODUCT OVERVIEW

Mini-Circuits' ZVA-24443G1+ is a co-axial, low noise, wideband and high gain amplifier operating from 24 GHz to 43.5 GHz¹. The model operates over a single positive supply range of +9 to +15 V, allowing users to choose their desired operating voltage. Internal DC-DC conversion circuitry maintains constant efficiency over the full input voltage range. The amplifier incorporates several DC-protection features such as over-voltage, reverse voltage and In-rush current that protects the amplifier from damage if mishandled during operation. The Amplifier is capable of delivering about 100mW (+20 dBm) of RF power over the entire band and has an excellent Noise figure performance of 1.7 dB, typ over the entire band, hence making it an ideal choice for applications with extremely demanding dynamic range requirements.

KEY FEATURES

Feature	Advantages
Wide-band amplifier, 24 to 43.5 GHz ¹	A single amplifier serves the need for applications including 5G bands (24 to 39 GHz), Q-Band SATCOM, Test & instrumentation etc.
<ul style="list-style-type: none"> • High Gain • Low Noise • Medium RF power 	The amplifier is capable of providing high gain of over 45 dB typ. in the entire operating band with extremely Low noise of 1.7 dB typ. and good RF power of about +20 dBm.
Adjustable DC Supply voltage	The device is capable of operating from +9 to +15 V with constant DC power consumption.
DC Protection – <ul style="list-style-type: none"> • Over-voltage • Reverse voltage • In-rush current 	The internal DC circuitry allows the amplifier to be protected from any external mishandling that could lead to catastrophic failures in the field.

1. Amplifier is usable down to 22 GHz





LOW NOISE, HIGH GAIN

Wideband Amplifier

ZVA-24443G1+ ZVA-24443G1X+

Mini-Circuits

ELECTRICAL SPECIFICATIONS AT 25°C

Parameter	Condition (MHz)	ZVA-24443G1+ ZVA-24443G1X+▲			Units
		Min.	Typ.	Max.	
Frequency Range ¹		24000	—	43500	MHz
Gain	24000 - 30000	38	43	—	dB
	30000 - 40000	38	45	—	
	40000 - 43500	40	48	—	
Noise Figure	24000 - 30000		1.75		dB
	30000 - 40000		1.50		
	40000 - 43500		1.75		
Output Power at 1dB compression	24000 - 30000		21		dBm
	30000 - 40000		23		
	40000 - 43500		21		
Output third order intercept point	24000 - 43500		27		dBm
Input VSWR	24000 - 30000		1.8		:1
	30000 - 40000		1.45		
	40000 - 43500		1.65		
Output VSWR ³	24000 - 30000		3.0		:1
	30000 - 40000		2.0		
	40000 - 43500		1.7		
Operating DC Voltage	24000 - 43500	+9	—	+15	V
Device Operating Current ² (at 9V DC)		—	—	375	mA
Device Operating Power at Operating DC Voltage		—	2.7	—	W

1. Amplifier is usable down to 22 GHz

2. DC Supply must be able to source at least 400mA DC at startup.

3. Open and short-circuit loads and not recommended at the amplifier output. Ensure proper 50 Ohm load before turning the amplifier "ON".

▲ For units without heat-sink, limit the maximum base-plate temperature to 50°C to ensure proper performance. Alternative heat sinking and heat removal can be provided by the user with max. thermal resistance of 1.8°C/W. This allows the max. base plate temperature to be +85°C.

MAXIMUM RATINGS⁵

Parameter	Ratings
Operating Temperature (Ambient)	-40°C to 85°C
Storage Temperature	-55°C to 100°C
Total Power dissipation	3.5W
Input Power (CW)	+5 dBm
DC Operating Voltage	+16V

5. Permanent damage may occur if any of these limits are exceeded.





LOW NOISE, HIGH GAIN

Wideband Amplifier

ZVA-24443G1+ ZVA-24443G1X+

OUTLINE DRAWING

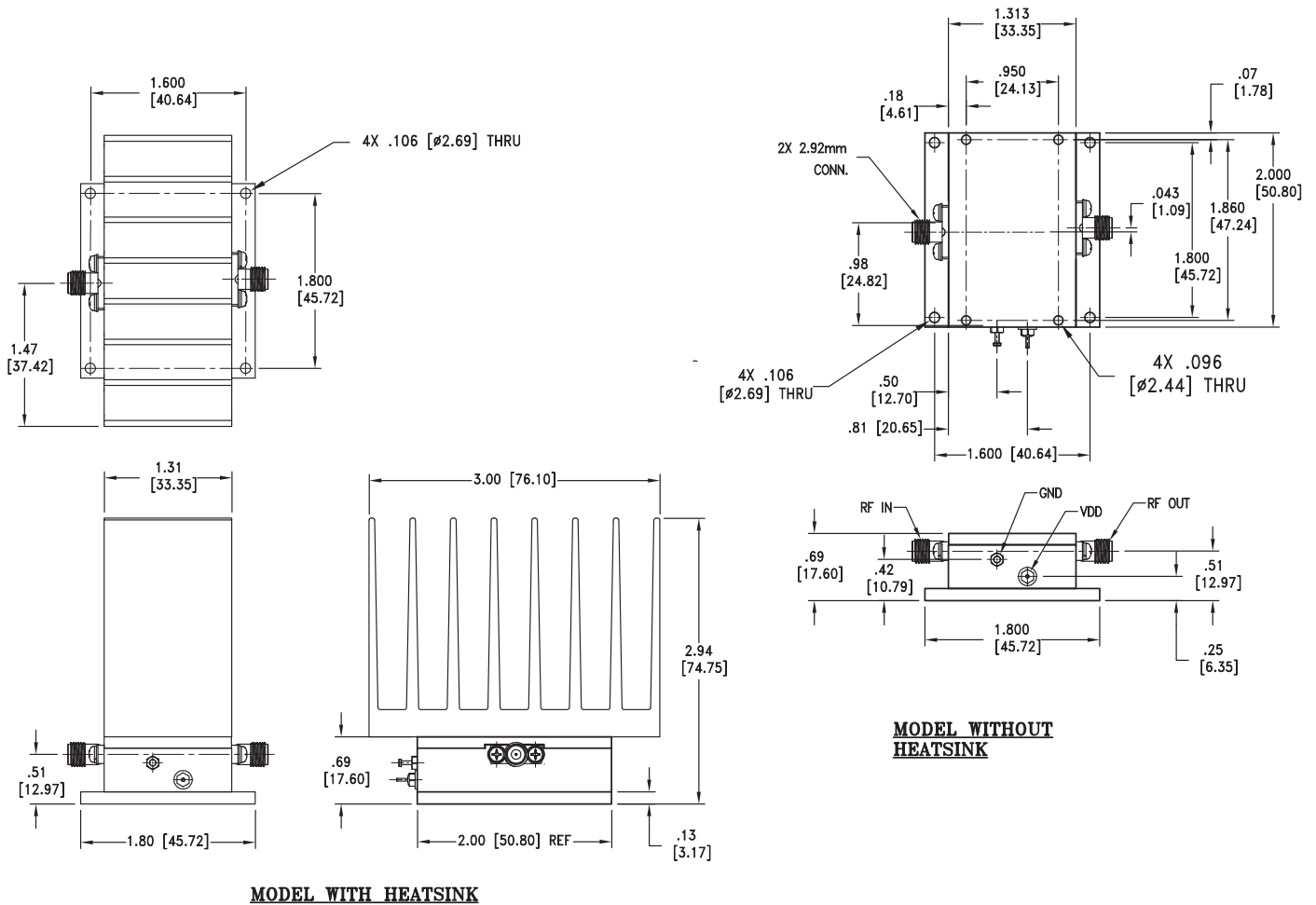

Weight: 350 grams; Weight without heatsink: 220 grams

Dimensions are in inches (mm). Tolerances: 2 Pl. ± .03; 3 Pl. ± .015



LOW NOISE, HIGH GAIN

Wideband Amplifier

ZVA-24443G1+ ZVA-24443G1X+

TYPICAL PERFORMANCE DATA/CURVES

Frequency (MHz)	Gain (dB)	Directivity (dB)	VSWR (:1)		Noise Figure (Db)	Pout at 1 Db Compr. (Dbm)	Pout at Saturation (Dbm)	Oip3 (Dbm)
			IN	OUT				
22000	45.69	46.34	2.60	2.21	2.66	21.38	22.02	29.48
24000	44.27	48.27	2.54	3.64	2.36	21.42	23.05	28.18
26000	42.88	58.65	1.93	3.93	2.10	20.47	22.77	27.54
28000	44.83	40.07	1.46	3.30	2.09	20.91	24.10	27.72
30000	45.93	39.76	1.76	3.18	1.84	21.90	24.25	26.14
32000	46.26	48.93	1.82	2.72	1.72	22.89	24.39	25.79
34000	45.75	31.21	1.55	1.75	1.76	23.82	24.44	26.67
36000	44.69	38.86	1.33	1.66	1.74	23.39	24.11	27.34
38000	45.25	38.19	1.18	1.96	1.88	22.12	23.66	26.79
40000	48.37	30.81	1.37	1.85	1.82	22.23	23.62	26.05
42000	49.42	38.69	1.49	1.50	1.47	20.92	21.99	26.15
43500	48.80	45.64	1.76	1.62	1.78	20.55	21.24	25.57

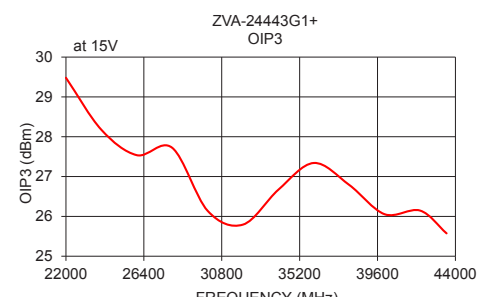
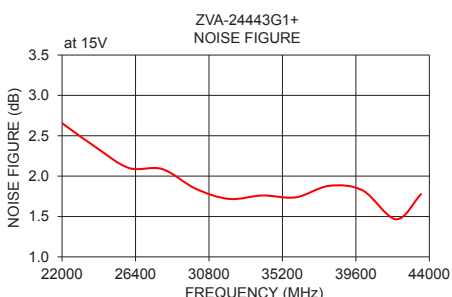
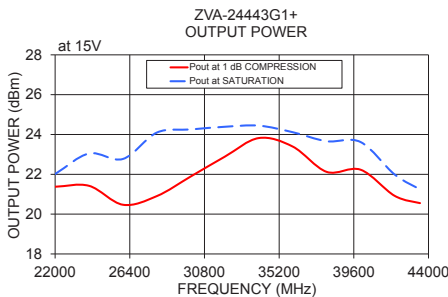
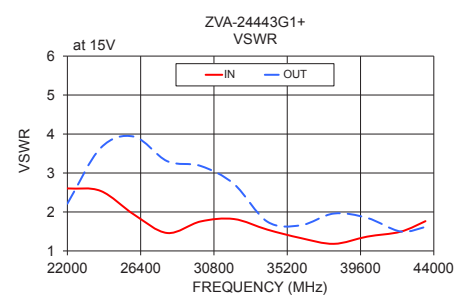
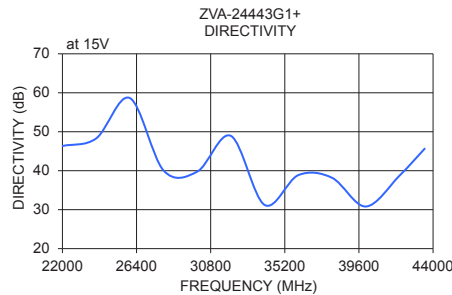
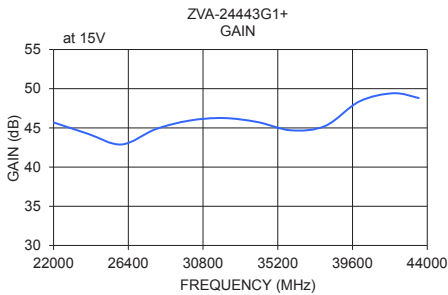

NOTES

- A. Performance and quality attributes and conditions not expressly stated in this specification document are intended to be excluded and do not form a part of this specification document.
- B. Electrical specifications and performance data contained in this specification document are based on Mini-Circuit's applicable established test performance criteria and measurement instructions.
- C. The parts covered by this specification document are subject to Mini-Circuits standard limited warranty and terms and conditions (collectively, "Standard Terms"); Purchasers of this part are entitled to the rights and benefits contained there in.
For a full statement of the standard. Terms and the exclusive rights and remedies thereunder, please visit Mini-Circuits' website at www.minicircuits.com/MCLStore/terms.jsp



Coaxial Amplifier

ZVA-24443G1+

Typical Performance Data

FREQUENCY (MHz)	GAIN (dB) 15V	DIRECTIVITY (dB) 15V	VSWR (:1)		NOISE FIGURE (dB) 15V	Pout at 1dB COMPRESSION (dBm) 15V	Pout at SATURATION (dBm) 15V	OUTPUT IP3 (dBm) 15V
			IN 15V	OUT 15V				
22000	45.69	46.34	2.60	2.21	2.66	21.38	22.02	29.48
22500	45.83	44.73	2.66	2.61	2.56	21.21	21.91	28.88
23000	45.55	45.52	2.66	3.01	2.48	21.70	22.63	28.48
23500	44.95	48.12	2.63	3.36	2.39	21.18	23.11	28.68
24000	44.27	48.27	2.54	3.64	2.36	21.42	23.05	28.18
24500	43.70	53.01	2.42	3.83	2.32	21.33	23.12	27.66
25000	43.19	39.11	2.28	3.95	2.27	21.34	23.57	28.04
25500	42.90	48.50	2.11	3.97	2.21	21.07	23.23	27.66
26000	42.88	58.65	1.93	3.93	2.10	20.47	22.77	27.54
26500	43.14	49.89	1.76	3.83	2.07	20.17	23.28	28.02
27000	43.63	35.75	1.60	3.67	2.08	20.29	23.19	27.79
27500	44.23	40.88	1.49	3.48	2.09	20.23	23.40	27.80
28000	44.83	40.07	1.46	3.30	2.09	20.91	24.10	27.72
28500	45.33	35.79	1.49	3.18	2.04	21.09	24.21	27.75
29000	45.64	33.33	1.56	3.12	1.95	20.89	24.21	27.56
29500	45.84	40.93	1.66	3.14	1.82	21.77	24.29	27.20
30000	45.93	39.76	1.76	3.18	1.84	21.90	24.25	26.14
30500	46.00	36.00	1.82	3.21	1.88	21.51	24.30	26.07
31000	46.06	41.68	1.84	3.15	1.90	22.35	24.66	26.24
31500	46.19	38.74	1.86	2.97	1.73	22.75	24.33	25.18
32000	46.26	48.93	1.82	2.72	1.72	22.89	24.39	25.79
32500	46.22	39.74	1.76	2.42	1.70	23.35	24.52	26.62
33000	46.16	35.40	1.71	2.13	1.84	23.83	24.58	26.44
33500	45.97	40.82	1.62	1.91	1.68	24.59	24.58	26.45
34000	45.75	31.21	1.55	1.75	1.76	23.82	24.44	26.67
34500	45.42	54.47	1.48	1.65	1.83	23.78	24.46	26.79
35000	45.15	37.54	1.41	1.62	1.85	24.20	24.33	27.13
35500	44.89	42.49	1.37	1.62	1.75	23.05	24.14	27.24
36000	44.69	38.86	1.33	1.66	1.74	23.39	24.11	27.34
36500	44.60	40.33	1.29	1.72	1.70	23.03	24.03	27.46
37000	44.66	40.90	1.25	1.80	1.85	22.98	23.66	27.32
37500	44.82	39.88	1.22	1.88	2.27	23.12	23.80	27.01
38000	45.25	38.19	1.18	1.96	1.88	22.12	23.66	26.79
38500	45.85	32.13	1.16	2.00	1.80	22.25	23.66	26.52
39000	46.66	33.22	1.20	1.99	1.73	22.60	23.59	26.53
39500	47.51	34.76	1.27	1.95	1.94	22.15	23.63	26.34
40000	48.37	30.81	1.37	1.85	1.82	22.23	23.62	26.05
40500	49.00	38.64	1.43	1.74	1.77	22.22	23.10	26.10
41000	49.42	29.20	1.48	1.65	1.75	21.96	22.97	26.32
41500	49.43	50.39	1.46	1.56	1.75	20.46	22.33	26.48
42000	49.42	38.69	1.49	1.50	1.47	20.92	21.99	26.15
42500	49.40	31.21	1.51	1.47	1.59	21.16	22.13	25.88
43000	49.27	36.93	1.62	1.49	1.49	20.56	21.84	25.90
43500	48.80	45.64	1.76	1.62	1.78	20.55	21.24	25.57
44000	47.71	32.97	1.91	1.86	1.74	20.75	20.77	25.29
44500	45.84	36.11	2.05	2.25	2.02	19.90	20.75	25.22
45000	43.34	47.49	2.15	2.74	2.09	18.62	19.59	24.67
45500	40.48	43.98	2.18	3.40	2.15	17.66	18.27	22.93
46000	37.58	39.58	2.20	4.15	2.47	16.80	17.50	21.16

Typical Performance Curves

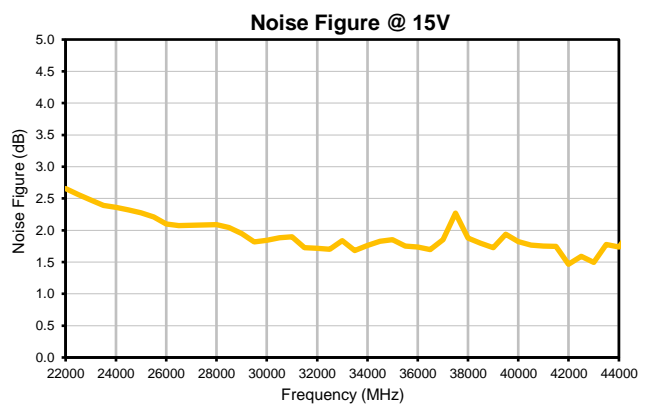
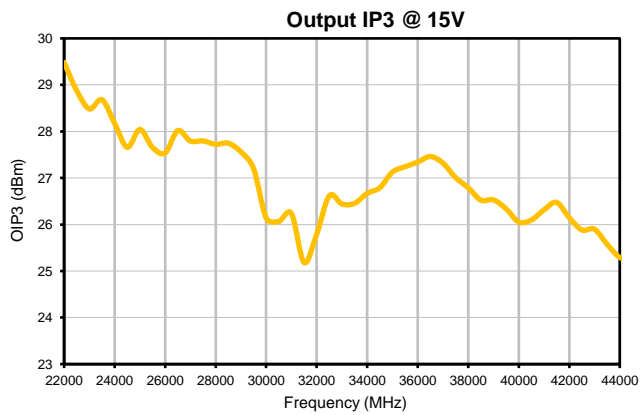
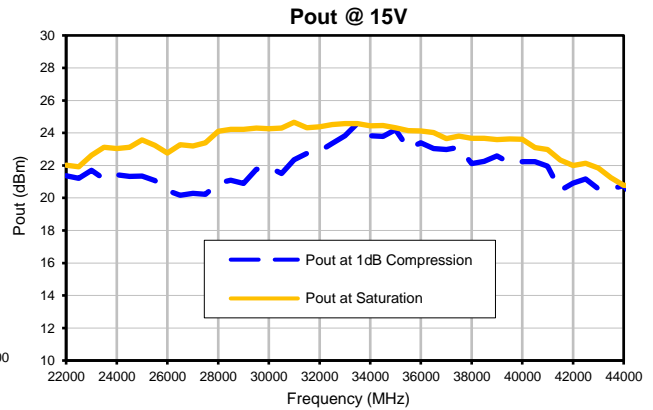
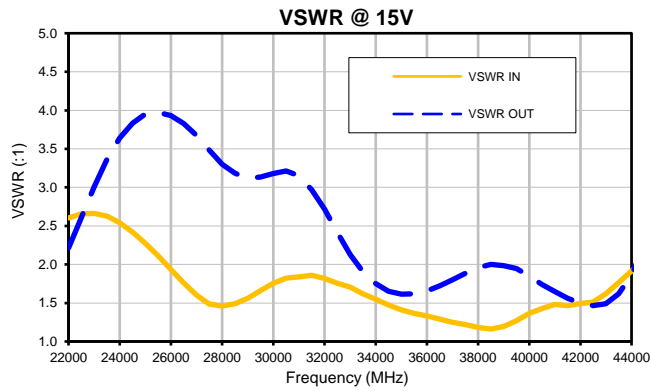
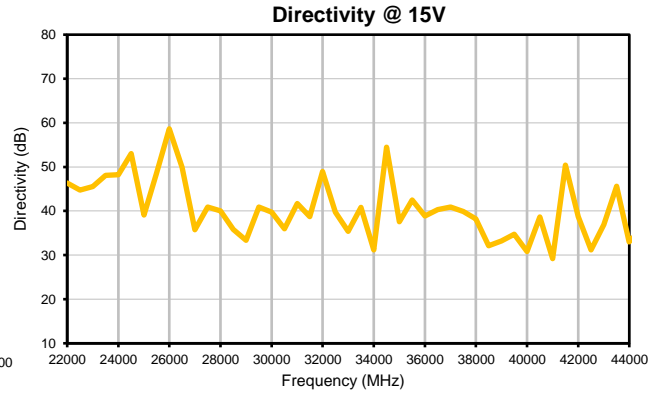
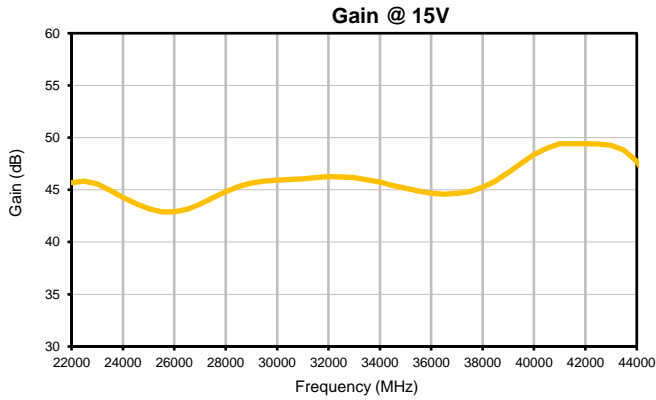

Case Style

T

Outline Dimensions

T2704

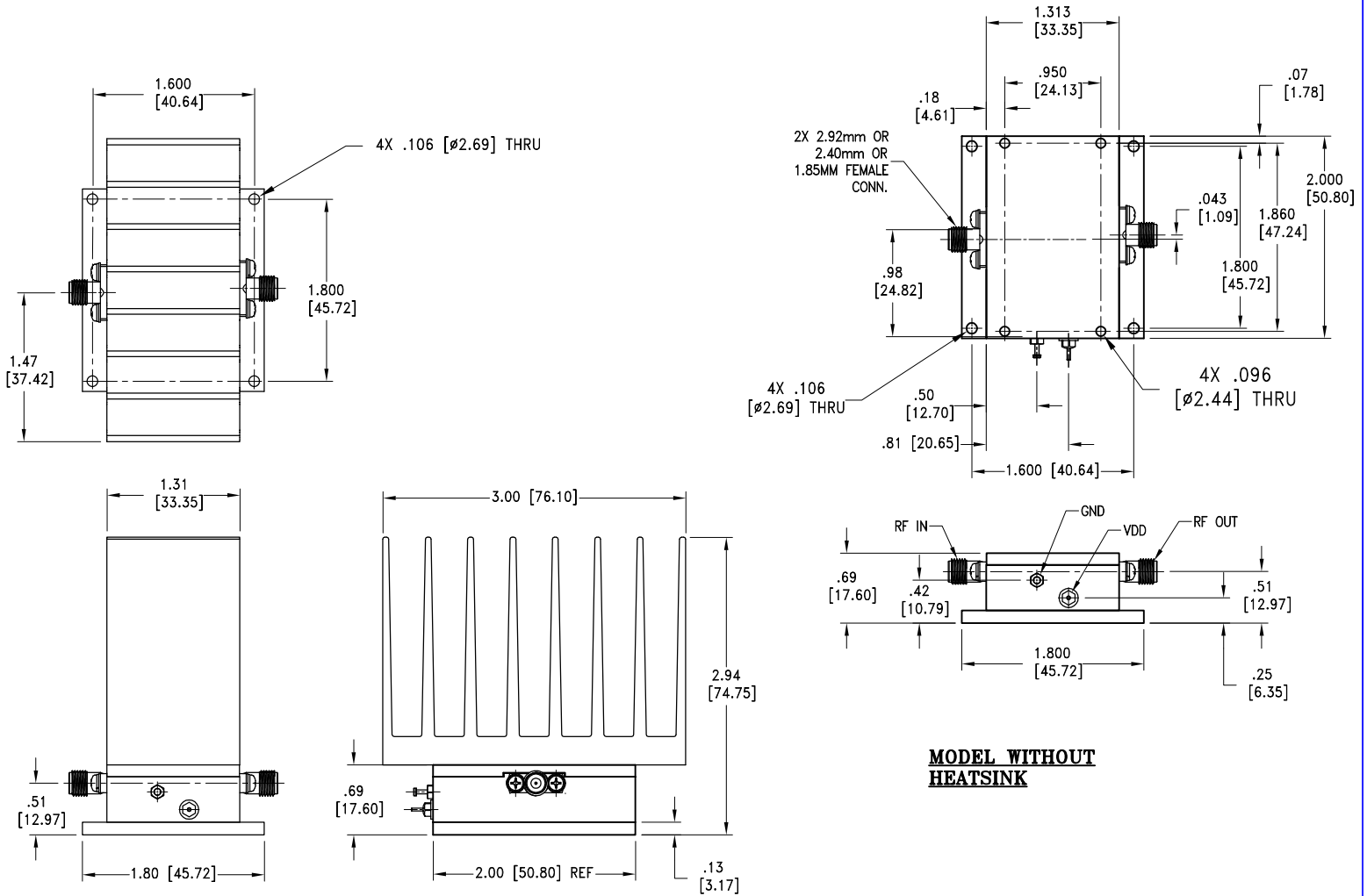

MODEL WITH HEATSINK

MODEL WITHOUT HEATSINK

Weight: 350 grams; Weight without heatsink: 220 grams

Dimensions are in inches (mm). Tolerances: 2 Pl.±.03; 3 Pl. ± .015

Notes:

1. Case Material: Brass Alloy
2. Case Finish: Gold Plating
3. Heat sink finish: Black anodize.

Mini-Circuits
ISO 9001 ISO 14001 CERTIFIED

ALL NEW
minicircuits.com

P.O. Box 350166, Brooklyn, New York 11235-0003 (718) 934-4500 Fax (718) 332-4661 For detailed performance specs & shopping online see Mini-Circuits web site



The Design Engineers Search Engine Provides ACTUAL Data Instantly From MINI-CIRCUITS At: www.minicircuits.com

RF/IF MICROWAVE COMPONENTS



All Mini-Circuits products are manufactured under exacting quality assurance and control standards, and are capable of meeting published specifications after being subjected to any or all of the following physical and environmental test.

Specification	Test/Inspection Condition	Reference/Spec
Operating Temperature	-40° to 85° C Ambient Environment	Individual Model Data Sheet
Base Plate Temperature	85°C	Unit with Heatsink
Storage Temperature	-55° to 100° C Ambient Environment	Individual Model Data Sheet
Stabilization Bake	(non-operating) 125°C, 24 hours	---
Burn-in at Elevated Temp.	(DC on) 72 hours at 85° C	----
Thermal Shock	-40° C to +85°C, 100 cycles	Transition time = 5 mins, Dwell time = 30 mins