



COAXIAL

# Variable Gain Amplifier

## ZVA-18443VG+ ZVA-18443VGX+

50Ω 18 to 43.5 GHz P<sub>SAT</sub> +31 dBm 2.92 mm Female

### THE BIG DEAL

- Variable Gain Amplifier with Analog or TTL Control
- Interactive GUI with Telemetry
- Calibrated 17 dB Attenuation Range with Minimal Power Degradation
- Flat Gain Response, ±2.5 dB
- High Gain, 47 dB Typ.
- High P<sub>SAT</sub>, +31 dBm Typ.
- Ideal for Integrated Sub-Systems



Generic photo used for illustration purposes only

### APPLICATIONS

- Wideband Test and Instrumentation
- 5G-FR2 Millimeter Wave Testing
- Aerospace & Defense
- Test and Measurement
- Broadband Telecom
- Ka-Band Satcom

### FUNCTIONAL DIAGRAM

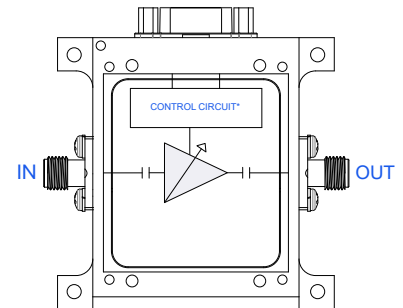

### PRODUCT OVERVIEW

Mini-Circuits' ZVA-18443VG(X)+ is a coaxial, wideband, variable gain, medium power amplifier with gain control, operating from 18 to 43.5 GHz. The model operates over a single supply range of +10 to +15 V, allowing users to choose their desired operating voltage. Internal DC-DC conversion circuitry maintains consistent efficiency over the full input voltage range. The amplifier incorporates a full suite of control and diagnostic tools, such as output power monitoring, amplifier fault tracking, internal temperature monitoring, enable/disable functionality for lower power consumption, and configurable digital or analog gain control.

The optional cable harness with integrated TTL to USB converter allows control of the amplifier from a PC moments after unboxing. Several DC-protection features such as over-voltage, reverse voltage, and in-rush current protection protect the amplifier from damage in case of unexpected spikes in voltage during operation. The high gain, low noise, medium power, and wideband frequency operation combined with digital control makes this amplifier an ideal choice for testing and instrumentation applications

### KEY FEATURES

Features	Advantages
Variable Gain, 17 dB Typ. Range	A single amplifier can be used for a variety of applications, where gain or power levels may need to be adjusted for optimal performance in the users' system.
Telemetry Reporting	With built-in temperature monitoring, power detection and alarm features, this amplifier gives the user valuable information that would otherwise require additional test equipment and control circuitry. See Telemetry Feature table for more information.
Wide DC Operating Voltage, +10 to +15 V	The device can operate from +10 to +15 V, maintaining consistent DC power consumption with no effect on RF performance, and facilitating ease of use in test setups with existing established voltage supplies.
DC Protection <ul style="list-style-type: none"> <li>• Over-Voltage</li> <li>• Reverse Voltage</li> <li>• In-Rush Current</li> </ul>	The internal DC circuitry allows the amplifier to be protected from external mishandling or unexpected spikes in voltage that could lead to catastrophic failures in the field.

REV. A  
ECO-028560  
ZVA-18443VG(X)+  
MCL NY  
260309



**COAXIAL**

# Variable Gain Amplifier

**ZVA-18443VG+**  
**ZVA-18443VGX+**50Ω 18 to 43.5 GHz P<sub>SAT</sub> +31 dBm 2.92 mm Female**ELECTRICAL SPECIFICATIONS AT +25 °C BASEPLATE, V<sub>S</sub> = +10 V**

Parameter	Condition (GHz)	Min.	Typ.	Max.	Units
Frequency Range		18		43.5	GHz
Gain at Minimum Attenuation	18-43.5	42	47		dB
Gain at Maximum Attenuation	18-43.5	25	30		dB
Output Power at 1 dB Compression at Minimum Attenuation	18-26	+25.0	+29.0		dBm
	26-40	+28.0	+30.5		
	40-43.5	+25.0	+28.5		
Output Power at 1 dB Compression at Maximum Attenuation	18-26		+28.0		dBm
	26-40		+29.5		
	40-43.5		+28.0		
Saturated Output Power (P <sub>SAT</sub> ) <sup>1</sup> at Minimum Attenuation	18-26	+28.0	+30.5		dBm
	26-40	+29.5	+32.0		
	40-43.5	+27.0	+30.0		
Saturated Output Power (P <sub>SAT</sub> ) <sup>1</sup> at Maximum Attenuation	18-26		+29.5		dBm
	26-40		+30.5		
	40-43.5		+29		
Output IP3 (Output Power = +14 dBm/Tone)	18-43.5		+41		dBm
Noise Figure	18-43.5		5.0		dB
Input Return Loss	18-43.5		13		dB
Output Return Loss	18-43.5		13		dB
DC Supply Voltage (V <sub>S</sub> )		+10		+15	V
DC Current at +12 V (ZVA-18443VGX+/ZVA-18443VG+)			1300/1400	2700/2800 <sup>2</sup>	mA

1. At P<sub>SAT</sub>, P<sub>OUT</sub> changes less than 0.1 dB for a 1 dB change in P<sub>IN</sub>.
2. Max DC current is measured at P<sub>SAT</sub>.

**TELEMETRY FEATURES**

Feature	Description
Temperature Monitoring	Allows the user to continuously monitor the internal temperature of the amplifier. (See page 5 for "TEMP MON OUTPUT VOLTAGE OVER INTERNAL TEMPERATURE OF MODULE" GRAPH.)
Mute/Unmute	Allows the user to mute or unmute the amplifier.
Attenuation Control	Allows the user to adjust the internal attenuation in increments of 0.25 dB.
Output Power Detector	Allows the user to continuously monitor the output power of the amplifier.
Alarm	Amplifier will go into alarm if internal temperature or current exceed factory set limits.
Digital or Analog Attenuation Control	Allows the user to control the attenuation digitally or with a single analog voltage.





COAXIAL

# Variable Gain Amplifier

## ZVA-18443VG+ ZVA-18443VGX+

50Ω 18 to 43.5 GHz P<sub>SAT</sub> +31 dBm 2.92 mm Female

### TYPICAL PERFORMANCE GRAPHS

GAIN @MINIMUM ATTENUATION

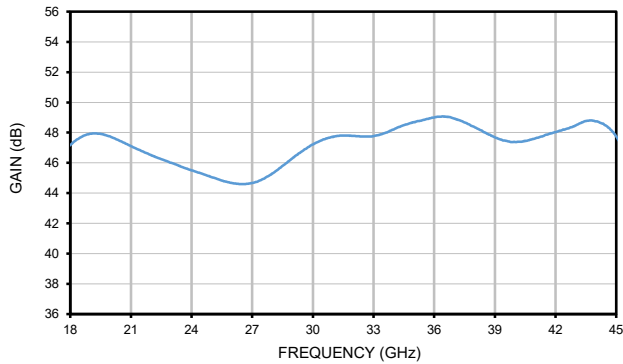

DIRECTIVITY @MINIMUM ATTENUATION

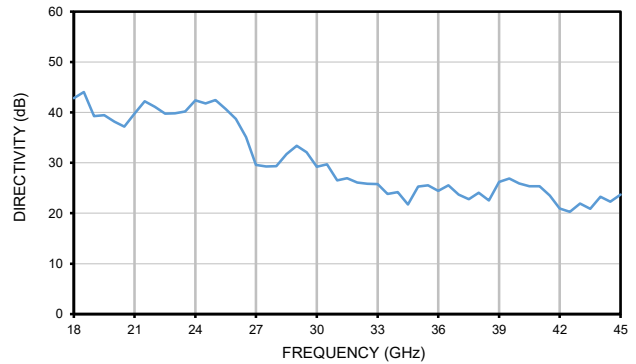

RETURN LOSS @MINIMUM ATTENUATION

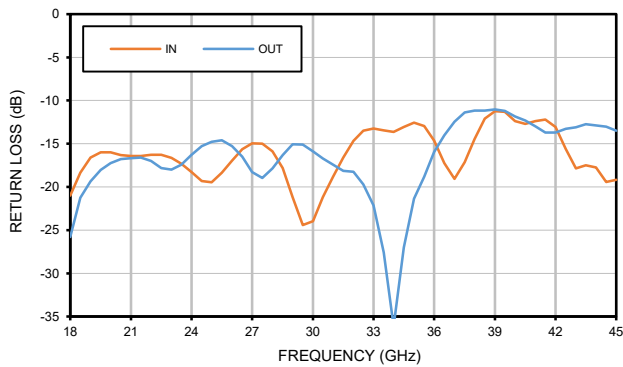

NOISE FIGURE @MINIMUM ATTENUATION

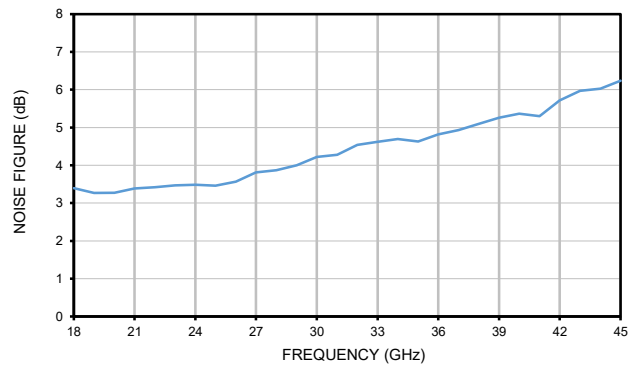

OUTPUT POWER @MINIMUM ATTENUATION

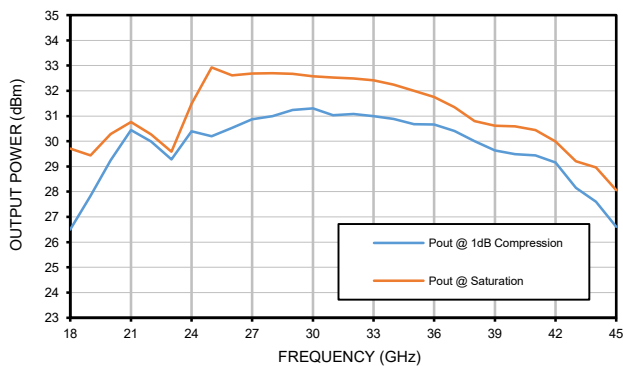

OIP3 @MINIMUM ATTENUATION

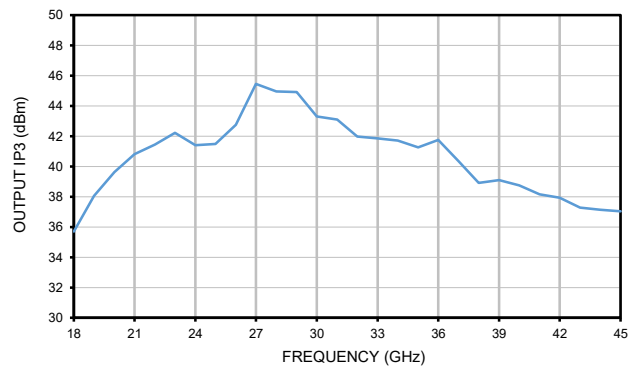



COAXIAL

# Variable Gain Amplifier

## ZVA-18443VG+ ZVA-18443VGX+

50Ω 18 to 43.5 GHz P<sub>SAT</sub> +31 dBm 2.92 mm Female

### TYPICAL PERFORMANCE GRAPHS

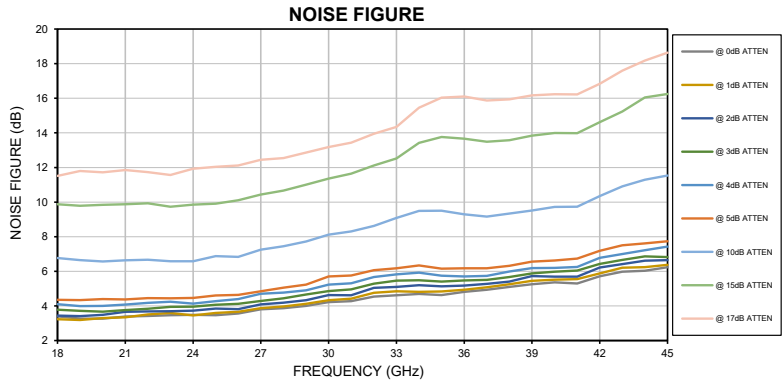
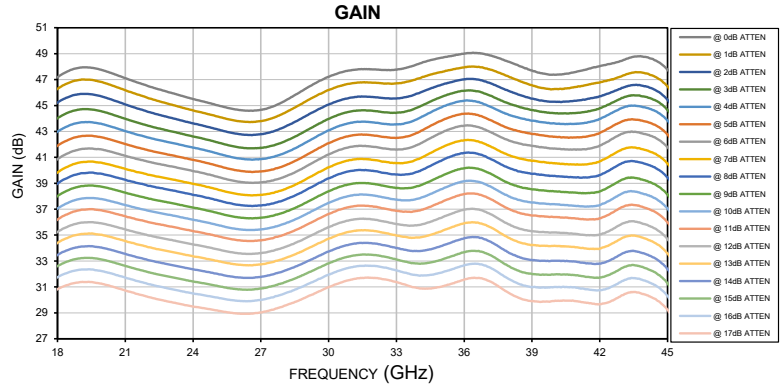



COAXIAL

# Variable Gain Amplifier

## ZVA-18443VG+ ZVA-18443VGX+

Mini-Circuits

50Ω 18 to 43.5 GHz P<sub>SAT</sub> +31 dBm 2.92 mm Female

### TYPICAL PERFORMANCE GRAPHS

#### OUTPUT POWER AT 1dB COMPRESSION

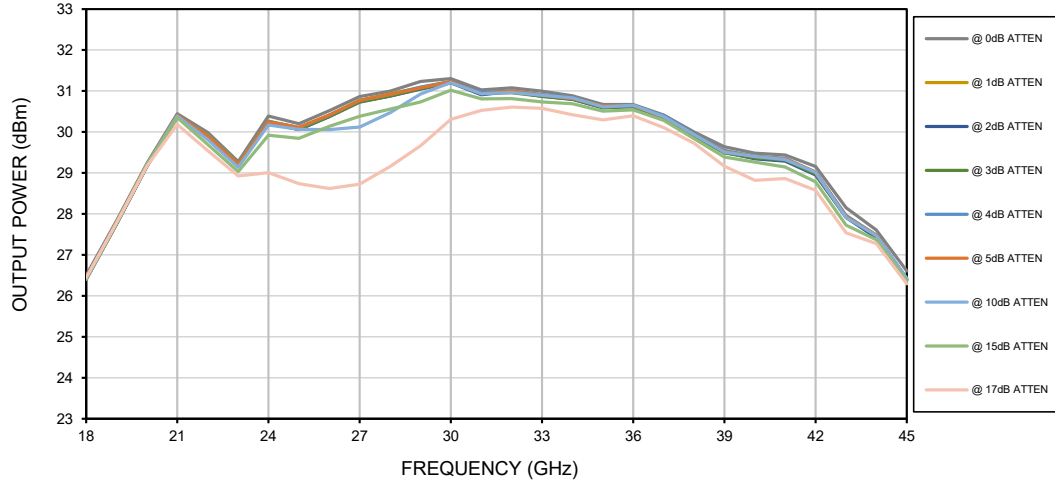

#### GAIN ATTENUATION OVER VVA CTRL VOLTAGE

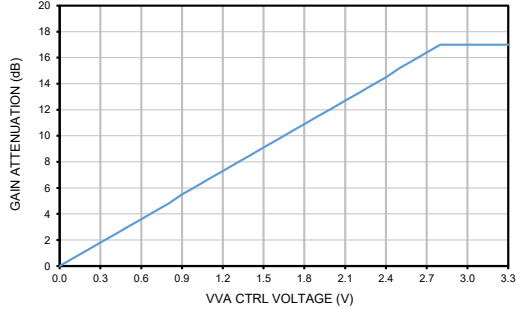

#### TEMP MON OUTPUT VOLTAGE OVER INTERNAL TEMPERATURE OF MODULE

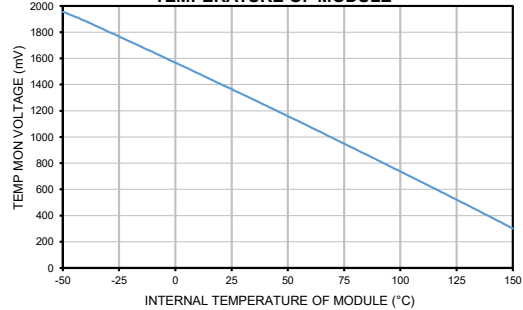



COAXIAL

# Variable Gain Amplifier

**ZVA-18443VG+**  
**ZVA-18443VGX+**

50Ω 18 to 43.5 GHz P<sub>SAT</sub> +31 dBm 2.92 mm Female

### ABSOLUTE MAXIMUM RATINGS<sup>3</sup>

Parameter	Ratings		
Operating Temperature	ZVA-18443VG+	-20 °C to +50 °C	Ambient
	ZVA-18443VGX+	-20 °C to +60 °C	Baseplate
Storage Temperature	-40 °C to +85 °C		
Total Power Dissipation	26 W		
RF Input Power <sup>4</sup> (CW)	+5 dBm		
DC Operating Voltage	+16 V		
Control Lines, J1-1 Through J1-8	+3.5 V		

3. Continuous operation is not recommended at these extremes. Permanent damage may occur if any of these limits are exceeded.

4. Specified under matched load to 50Ω.

### DETERMINING MAXIMUM THERMAL RESISTANCE OF USERS' EXTERNAL HEATSINK

$\text{MAXIMUM THERMAL RESISTANCE} = \frac{\text{MAXIMUM OPERATING CASE TEMP} - \text{MAXIMUM USER AMBIENT TEMP}}{\text{POWER DISSIPATION}}$	
<b>Example:</b>	MAXIMUM OPERATING CASE TEMP = +60 °C (CHECK MAXIMUM RATINGS TABLE FOR THIS VALUE) MAXIMUM USER AMBIENT TEMP = +30 °C (USER DEFINED) POWER DISSIPATION = 26 WATTS (CHECK MAXIMUM RATINGS TABLE FOR THIS VALUE) THEN MAXIMUM ALLOWABLE THERMAL RESISTANCE = 2 °C/W



COAXIAL

# Variable Gain Amplifier

## ZVA-18443VG+ ZVA-18443VGX+

Mini-Circuits

50Ω 18 to 43.5 GHz P<sub>SAT</sub> +31 dBm 2.92 mm Female

### CASE STYLE DRAWING FOR MODELS WITH HEATSINK (ZVA-18443VG+)

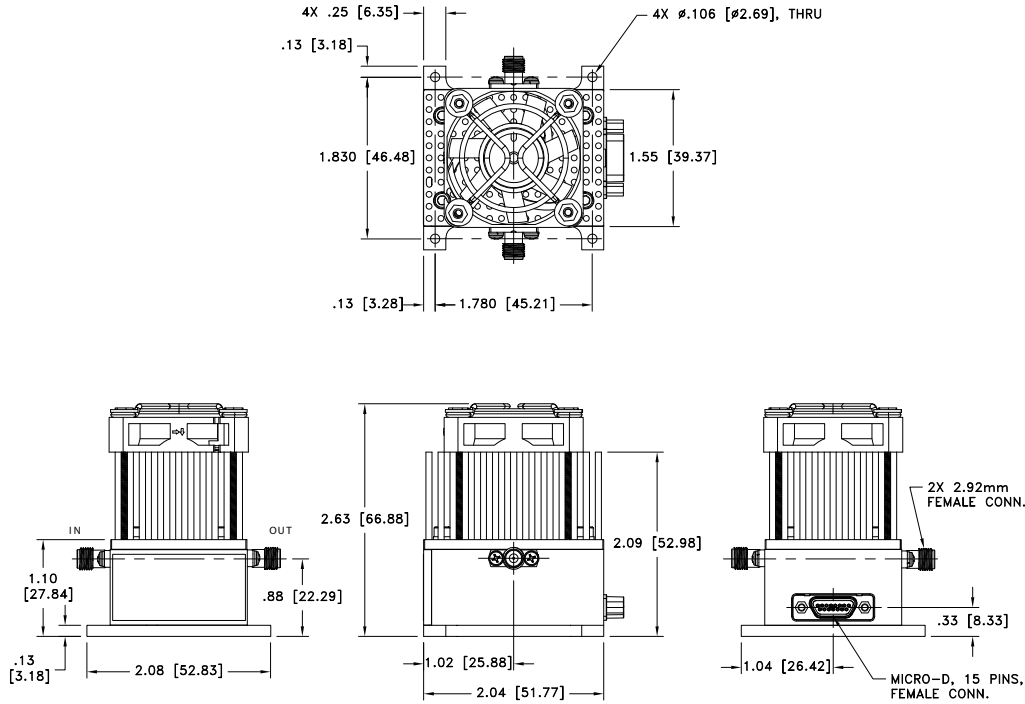

Weight: 6.8 oz. (193 grams)  
Dimensions are in inches [mm]. Tolerances: 2 Pl.±.03; 3 Pl.±.015 Inch

### CASE STYLE DRAWING FOR MODELS WITHOUT HEATSINK (ZVA-18443VGX+)

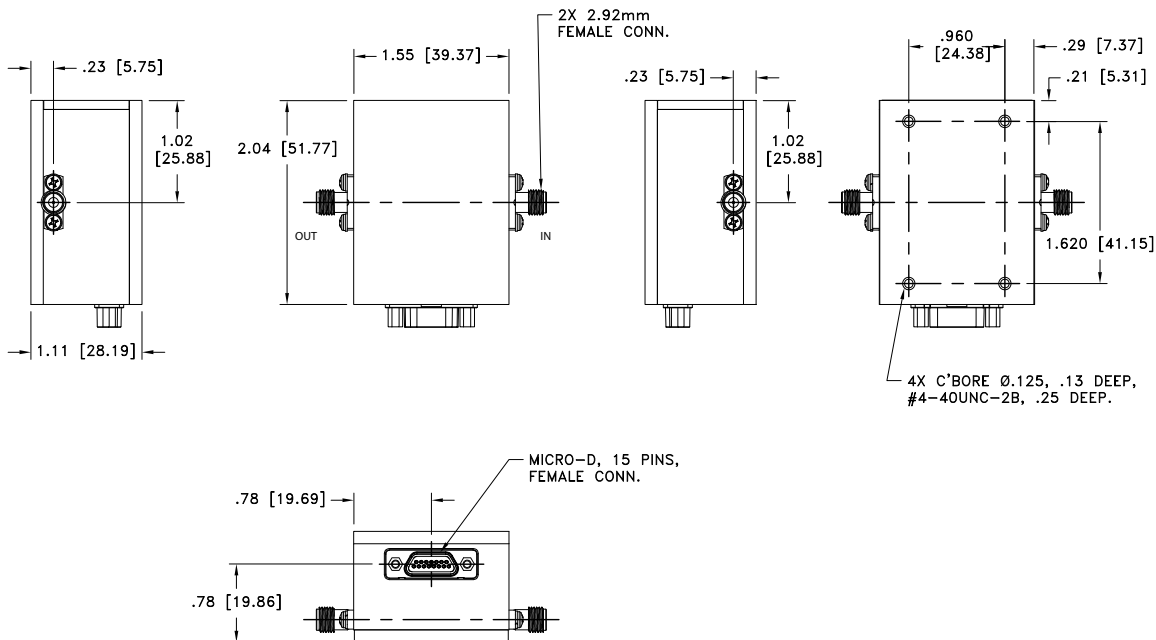

Weight: 6.5 oz. (184 grams)  
Dimensions are in inches [mm]. Tolerances: 2 Pl.±.03; 3 Pl.±.015 Inch





COAXIAL

# Variable Gain Amplifier

## ZVA-18443VG+ ZVA-18443VGX+

50Ω 18 to 43.5 GHz P<sub>SAT</sub> +31 dBm 2.92 mm Female

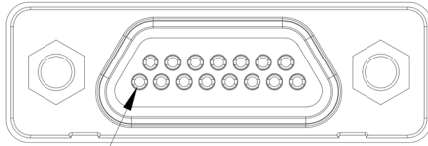

PIN 1

Function	Pin Number	Description
ALARM OUT	J1-1	Normally logic low (0 V), +3.3 V when fault is present
ENABLE IN <sup>5</sup>	J1-2	Logic low (0 V) to unmute (enable), logic high to mute (disable)
TEMP MON	J1-3	Provides analog output voltage representing temperature of module
RXD	J1-4	For optional USB to TTL converter (see Figure 3) - Connect to converter's TXD port
TXD	J1-5	For optional USB to TTL converter (see Figure 3) - Connect to converter's RXD port
VVA CTRL	J1-6	Analog Input for gain control, +3.3 V MAX (see Figure 1 & Figure 2)
+3.3 V	J1-7	Available voltage supply for analog gain control circuit (see Figure 1)
VVA/DCA <sup>6</sup>	J1-8	Logic low (0 V) for analog gain control, logic high (+3.3 V) for digital gain control using external USB to TTL converter
+V <sub>s</sub>	J1-9	Positive Supply Voltage
+V <sub>s</sub>	J1-10	Positive Supply Voltage
+V <sub>s</sub>	J1-11	Positive Supply Voltage
N/C	J1-12	NOT USED
GND	J1-13	Ground
GND	J1-14	Ground
GND	J1-15	Ground

5. J1-2 can also be left floating to disable the amplifier.

6. J1-8 can also be left floating for digital gain control option.

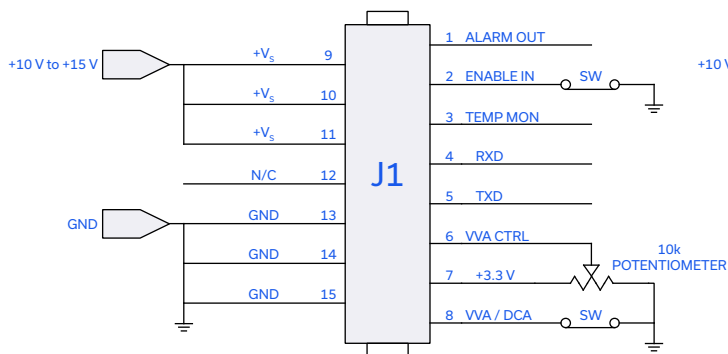

FIGURE 1

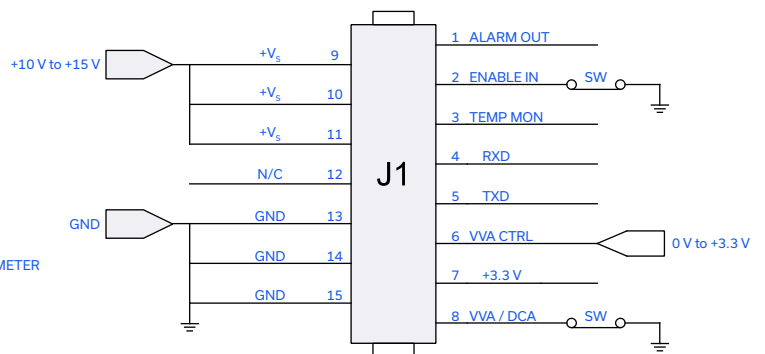

FIGURE 2

When J1-8 is grounded, the circuit shown in Figure 1 can be used to provide an analog input voltage to J1-6. The user also has the option to provide their own control voltage to pin J1-6 per Figure 2. See calculation below for gain attenuation control details:

$$\text{Gain Attenuation} = 20 * (\text{VVA CTRL VOLTAGE}) / +3.3 \text{ V dB}$$

Example: If voltage on J1-6 is +1 V, then gain will be attenuated by 6 dB. See page 5 for "GAIN ATTENUATION OVER VVA CTRL VOLTAGE" graph.



COAXIAL

# Variable Gain Amplifier

**ZVA-18443VG+**  
**ZVA-18443VGX+**

50Ω 18 to 43.5 GHz P<sub>SAT</sub> +31 dBm 2.92 mm Female

## INCLUDED ACCESSORIES

B20-9-0065-15 is a "Pigtail" connector included with every purchase of ZVA-18443VG(X)+. B20-9-0065-15 is a shielded cable with stripped wires (#28 AWG) on one end and a connector on the other end designed to mate to the ZVA-18443VG(X)+. These bare wires enable the customer to assemble their own cable as required to interface with the ZVA-18443VG(X)+ (cable length is 3 ft/0.9 meters).

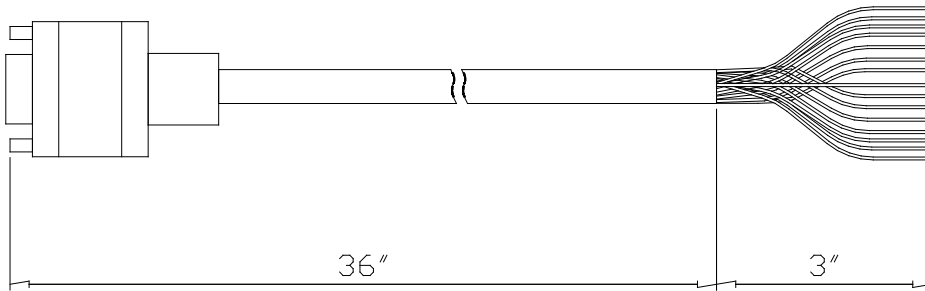

## B20-9-0065-15 WIRING INFORMATION

Function	Pin Number	Description	Wire Color
ALARM OUT	J1-1	Normally logic low (0 V), +3.3 V when fault is present	White
ENABLE IN	J1-2	Logic low (0 V) to unmute (enable), logic high to mute (disable)	Black
TEMP MON	J1-3	Provides analog output voltage representing temperature of module	Red
RXD	J1-4	For optional USB to TTL converter (see Figure 3) - Connect to converter's TXD port	Green
TXD	J1-5	For optional USB to TTL converter (see Figure 3) - Connect to converter's RXD port	Orange
VVA CTRL	J1-6	Analog Input for gain control, +3.3 V MAX	Light Blue
+3.3 V	J1-7	Available voltage supply for analog gain control circuit (see Figure 1)	White/Black
VVA/DCA	J1-8	Logic low (0 V) for analog gain control, logic high (+3.3 V) for digital gain control	Red/Black
+V <sub>s</sub>	J1-9	Positive Supply Voltage	Green/Black
+V <sub>s</sub>	J1-10	Positive Supply Voltage	Orange/Black
+V <sub>s</sub>	J1-11	Positive Supply Voltage	Blue/Black
N/C	J1-12	NOT USED	Black/White
GND	J1-13	Ground	Red/White
GND	J1-14	Ground	Green/White
GND	Shield	Ground	Shield



COAXIAL

# Variable Gain Amplifier

## ZVA-18443VG+ ZVA-18443VGX+

50Ω 18 to 43.5 GHz P<sub>SAT</sub> +31 dBm 2.92 mm Female

### GRAPHICAL USER INTERFACE (GUI) FOR WINDOWS – KEY FEATURES

- Connect via USB (see Figure 3)
- Mute and Unmute the amplifier
- Monitor internal temperature of the amplifier
- Monitor output power of the amplifier
- Adjust attenuation via the slider shown below
- Monitor Alarm for any potential faults exhibited by the amplifier

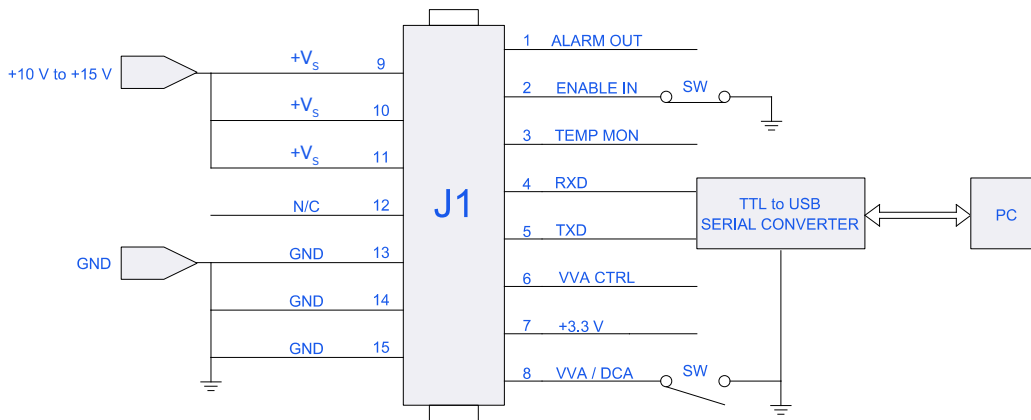
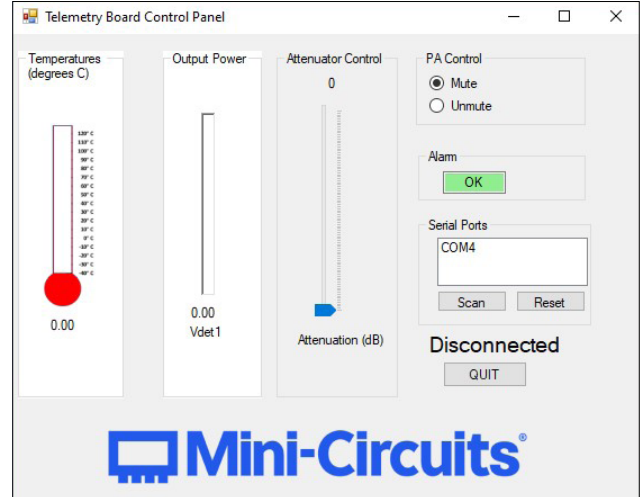

Figure 3

Suggest using TTL-232RG-VSW5V-WE from DigiKey for TTL to USB SERIAL CONVERTER





COAXIAL

# Variable Gain Amplifier

**ZVA-18443VG+**  
**ZVA-18443VGX+**

50Ω 18 to 43.5 GHz P<sub>SAT</sub> +31 dBm 2.92 mm Female

**ADDITIONAL INFORMATION IS AVAILABLE ON OUR DASHBOARD.**

Performance Data & Graphs	Data Graphs S-Parameter (S2P Files) Data Set (.zip file)
RoHS Status	Compliant
Environmental Ratings	ENV141
Export Information	ECCN # 3A001.B.4 This item will require an export license when shipped to certain countries.

**ORDERING INFORMATION**

Model No. Links	<a href="#">ZVA-18443VG+</a>	<a href="#">ZVA-18443VGX+</a>
Option	With Heatsink	Without Heatsink
Product Marking	ZVA-18443VG+	ZVA-18443VGX+
Case Style	YU3369	YU3369-1
Connector	2.92 mm female	

**NOTES**

- A. Performance and quality attributes and conditions not expressly stated in this specification document are intended to be excluded and do not form a part of this specification document.
- B. Electrical specifications and performance data contained in this specification document are based on Mini-Circuit's applicable established test performance criteria and measurement instructions.
- C. The parts covered by this specification document are subject to Mini-Circuits standard limited warranty and terms and conditions (collectively, "Standard Terms"); Purchasers of this part are entitled to the rights and benefits contained therein. For a full statement of the standard terms and the exclusive rights and remedies thereunder, please visit Mini-Circuits' website at [www.minicircuits.com/terms/viewterm.html](http://www.minicircuits.com/terms/viewterm.html)



Typical Performance Data @ 0dB Attenuation

FREQUENCY (GHz)	GAIN (dB)	DIRECTIVITY (dB)	RETURN LOSS (dB)		Pout @ 1 dB COMPRESSION (dBm)	Pout at SATURATION (dBm)	Output IP3 (dBm)	Noise Figure (dB)
			IN	OUT				
18	47.15	43.38	20.98	25.79	26.50	29.71	35.70	3.40
19	47.92	39.92	18.36	21.25	27.84	29.44	38.05	3.27
20	47.73	38.83	16.60	19.37	29.24	30.29	39.63	3.27
21	47.12	40.36	16.00	18.04	30.45	30.77	40.81	3.38
22	46.52	41.65	16.01	17.25	29.99	30.27	41.45	3.42
23	46.00	40.29	16.32	16.78	29.27	29.59	42.22	3.47
24	45.53	42.70	16.42	16.66	30.39	31.48	41.41	3.48
25	45.08	42.74	16.41	16.62	30.20	32.93	41.49	3.46
26	44.67	38.91	16.27	17.01	30.52	32.61	42.74	3.56
27	44.66	29.68	16.29	17.83	30.87	32.69	45.45	3.81
28	45.29	29.42	16.62	17.98	31.00	32.69	44.96	3.87
29	46.29	33.57	17.30	17.43	31.23	32.67	44.91	4.00
30	47.22	29.39	18.26	16.27	31.30	32.57	43.29	4.22
31	47.71	26.73	19.30	15.28	31.03	32.52	43.09	4.28
32	47.79	26.28	19.46	14.76	31.08	32.49	41.98	4.54
33	47.77	26.01	18.34	14.58	31.00	32.41	41.84	4.62
34	48.20	24.49	16.95	15.27	30.88	32.24	41.71	4.70
35	48.68	25.58	15.65	16.50	30.67	32.00	41.26	4.63
36	49.00	24.55	14.96	18.29	30.67	31.76	41.75	4.82
37	48.94	23.63	15.00	18.96	30.41	31.35	40.34	4.93
38	48.37	23.80	15.87	17.84	30.00	30.80	38.91	5.10
39	47.71	25.71	17.83	16.30	29.64	30.61	39.09	5.26
40	47.38	25.40	21.18	15.08	29.48	30.59	38.75	5.36
41	47.62	24.77	24.41	15.10	29.44	30.45	38.16	5.30
42	48.03	20.23	23.97	15.87	29.16	30.00	37.94	5.72
43	48.45	21.19	21.18	16.72	28.15	29.21	37.28	5.97
44	48.75	22.26	18.83	17.43	27.61	28.96	37.14	6.03
45	47.78	22.72	16.59	18.13	26.60	28.06	37.04	6.24

Typical Gain over Attenuation

FREQUENCY (GHz)	GAIN							
	1 dB	2 dB	3 dB	4 dB	5 dB	10 dB	15 dB	17 dB
18	46.25	45.19	44.00	42.95	41.86	37.01	32.58	30.79
19	46.98	45.88	44.69	43.68	42.61	37.78	33.20	31.36
20	46.80	45.68	44.54	43.56	42.54	37.77	33.11	31.23
21	46.19	45.09	43.98	43.04	42.04	37.33	32.63	30.74
22	45.59	44.52	43.45	42.53	41.55	36.89	32.15	30.23
23	45.09	44.06	43.03	42.15	41.18	36.55	31.77	29.84
24	44.65	43.64	42.63	41.77	40.82	36.21	31.43	29.50
25	44.20	43.21	42.21	41.35	40.41	35.83	31.11	29.21
26	43.80	42.81	41.79	40.93	39.99	35.46	30.82	28.95
27	43.80	42.78	41.74	40.86	39.91	35.44	30.88	29.04
28	44.36	43.28	42.17	41.27	40.31	35.83	31.30	29.48
29	45.32	44.17	43.04	42.14	41.15	36.60	32.01	30.19
30	46.19	45.06	43.96	43.07	42.08	37.47	32.81	30.97
31	46.70	45.61	44.55	43.68	42.68	38.06	33.39	31.57
32	46.76	45.64	44.58	43.69	42.68	38.05	33.46	31.69
33	46.71	45.54	44.43	43.54	42.50	37.74	33.13	31.39
34	47.08	45.94	44.87	43.98	42.93	37.81	32.80	30.92
35	47.58	46.59	45.65	44.83	43.81	38.53	33.08	31.01
36	47.93	47.01	46.13	45.36	44.35	39.14	33.66	31.54
37	47.86	46.83	45.89	45.04	44.02	38.89	33.59	31.55
38	47.22	46.12	45.15	44.27	43.23	37.98	32.59	30.52
39	46.57	45.53	44.65	43.83	42.81	37.52	32.00	29.90
40	46.28	45.29	44.41	43.62	42.59	37.39	31.97	29.91
41	46.44	45.38	44.44	43.60	42.55	37.25	31.90	29.89
42	46.76	45.69	44.75	43.94	42.84	37.29	31.71	29.66
43	47.26	46.36	45.58	44.81	43.75	38.20	32.45	30.35
44	47.51	46.49	45.70	44.86	43.79	38.15	32.48	30.42
45	46.51	45.47	44.68	43.86	42.79	37.08	31.31	29.27

# Coaxial Amplifier

# ZVA-18443VG(X)+

## Typical Performance Curves

GAIN @MINIMUM ATTENUATION

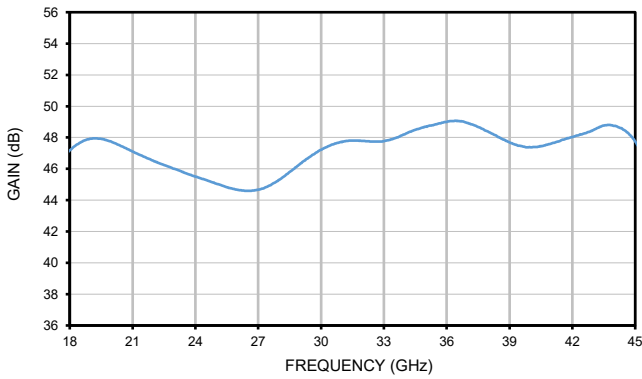

DIRECTIVITY @MINIMUM ATTENUATION

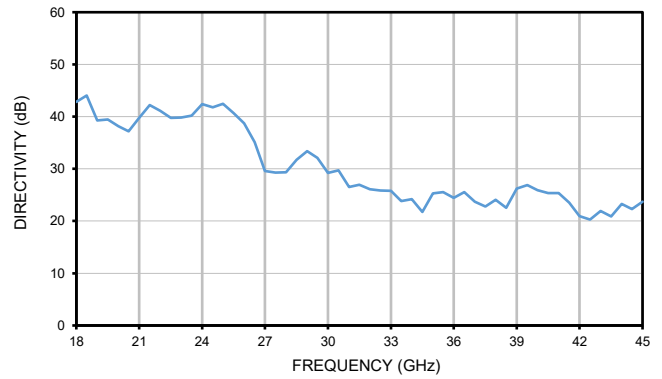

RETURN LOSS @MINIMUM ATTENUATION

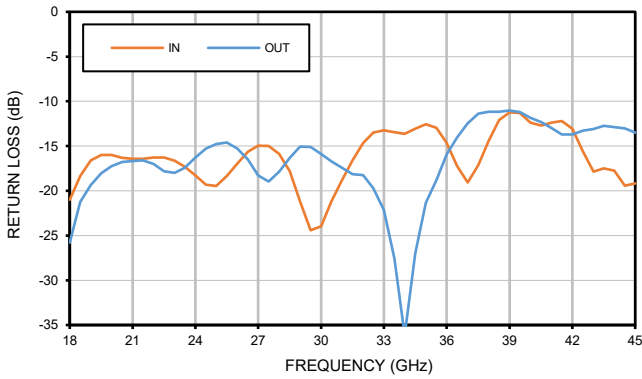

NOISE FIGURE @MINIMUM ATTENUATION

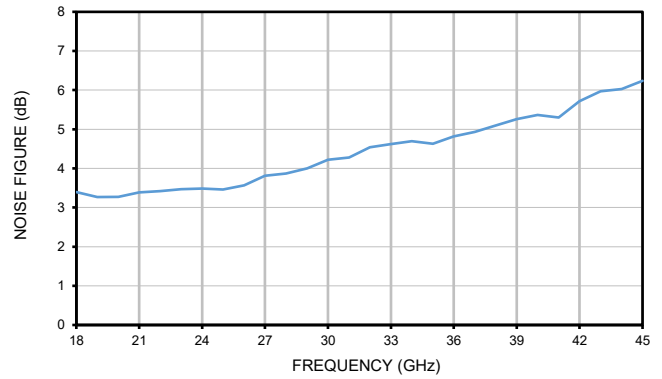

OUTPUT POWER @MINIMUM ATTENUATION

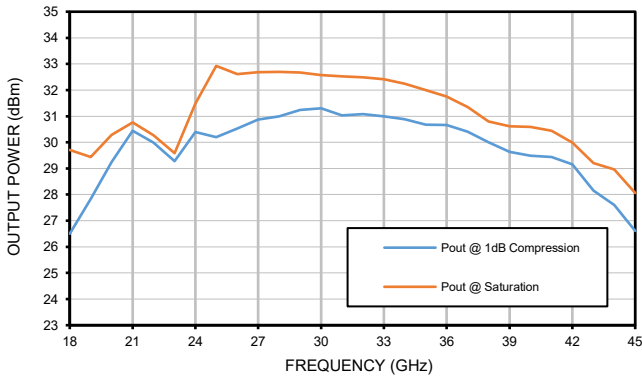

OIP3 @MINIMUM ATTENUATION

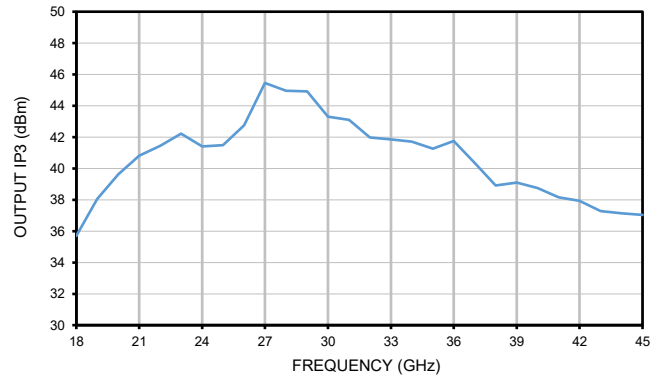

## Typical Performance Curves

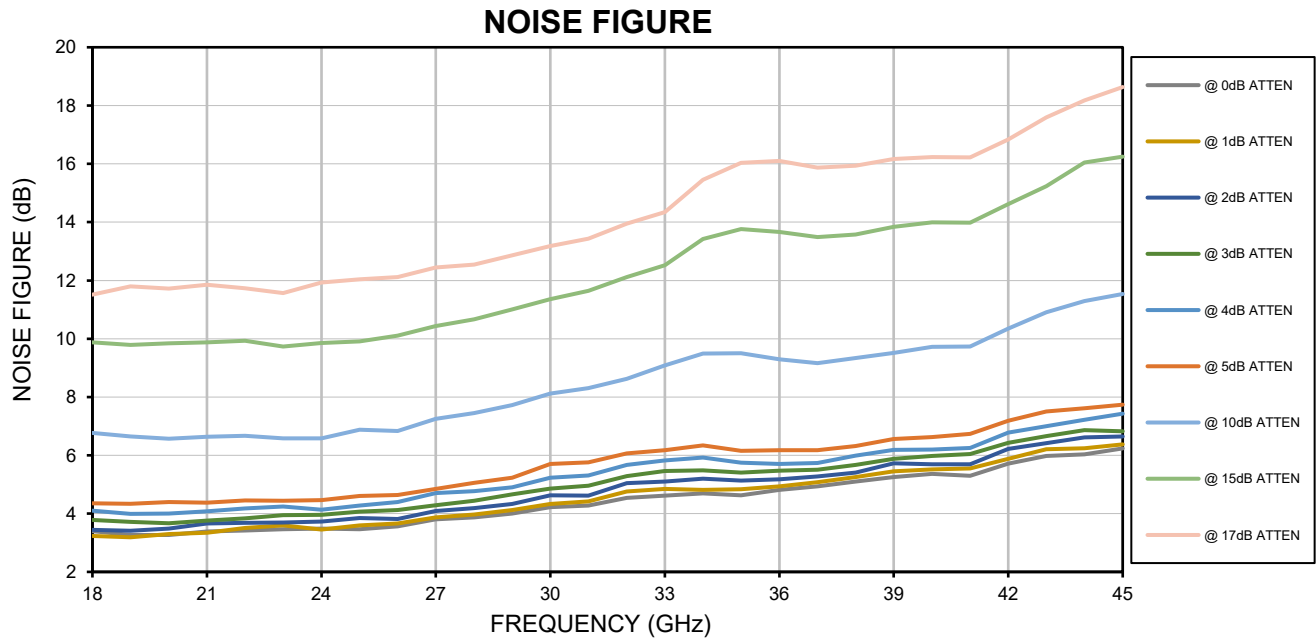
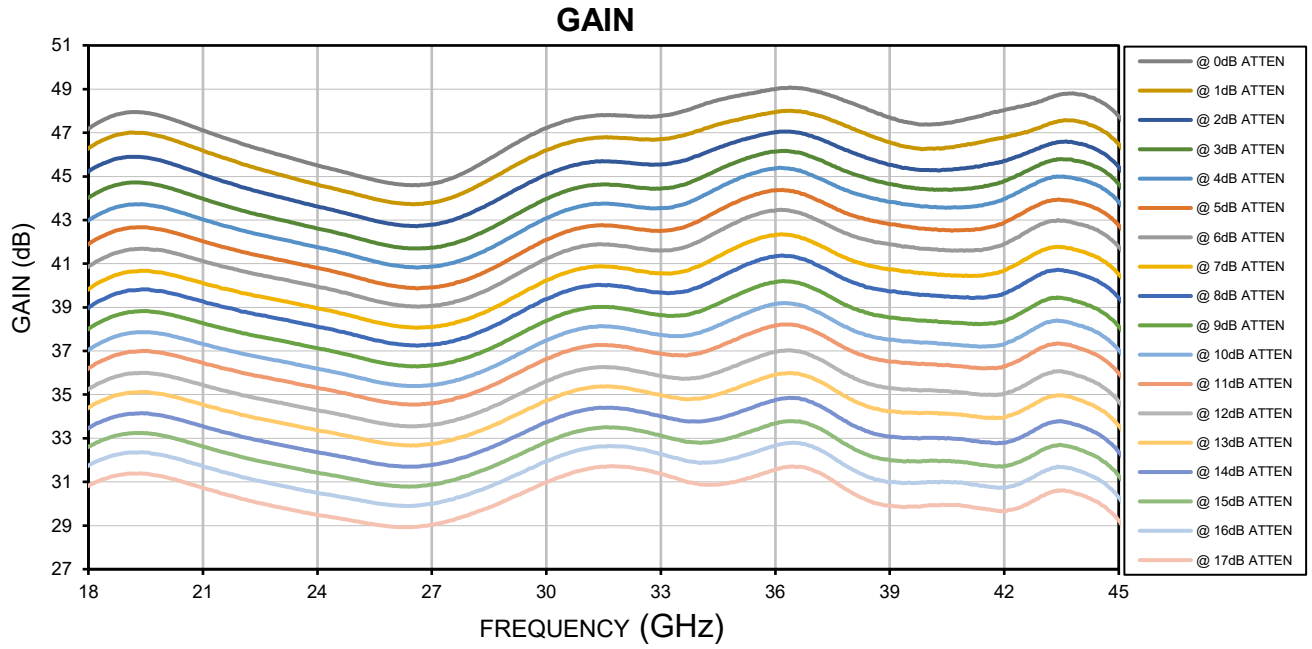

## Typical Performance Curves

### OUTPUT POWER AT 1dB COMPRESSION

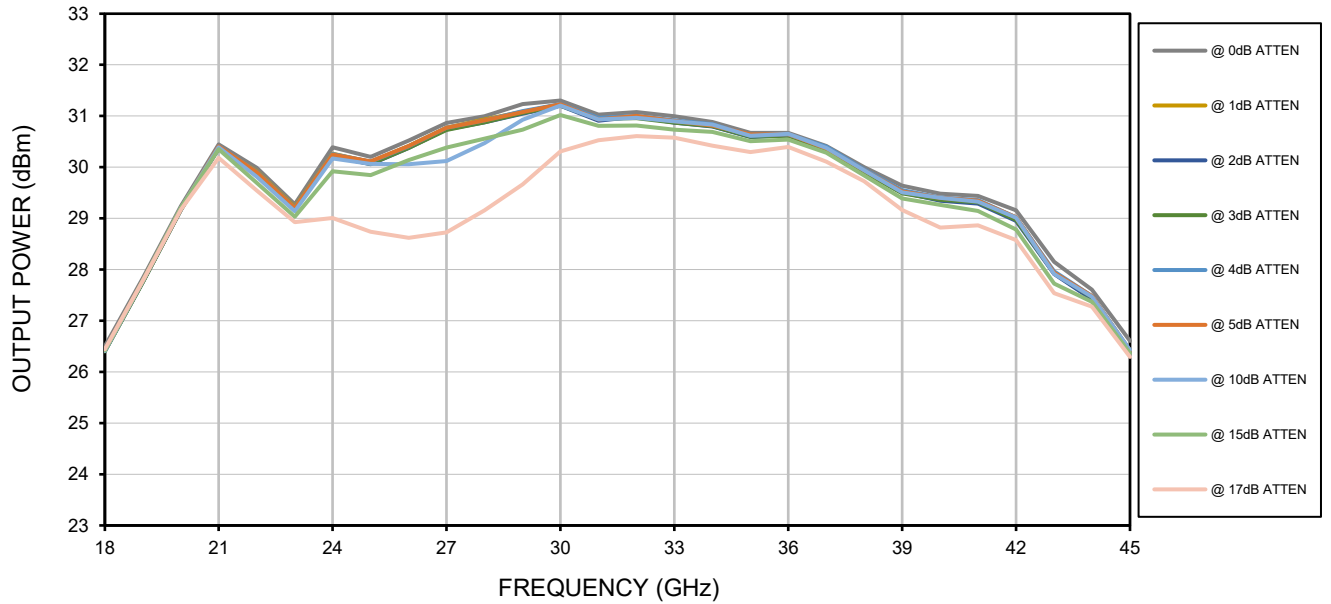

### GAIN ATTENUATION OVER VVA CTRL VOLTAGE

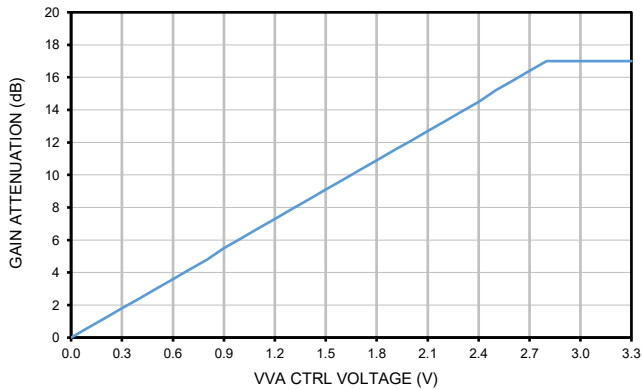

### TEMP MON OUTPUT VOLTAGE OVER INTERNAL TEMPERATURE OF MODULE

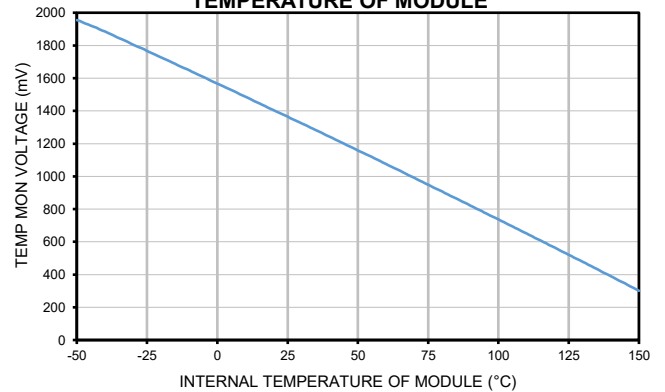

# Case Style

YU

## Outline Dimensions

YU3369-1

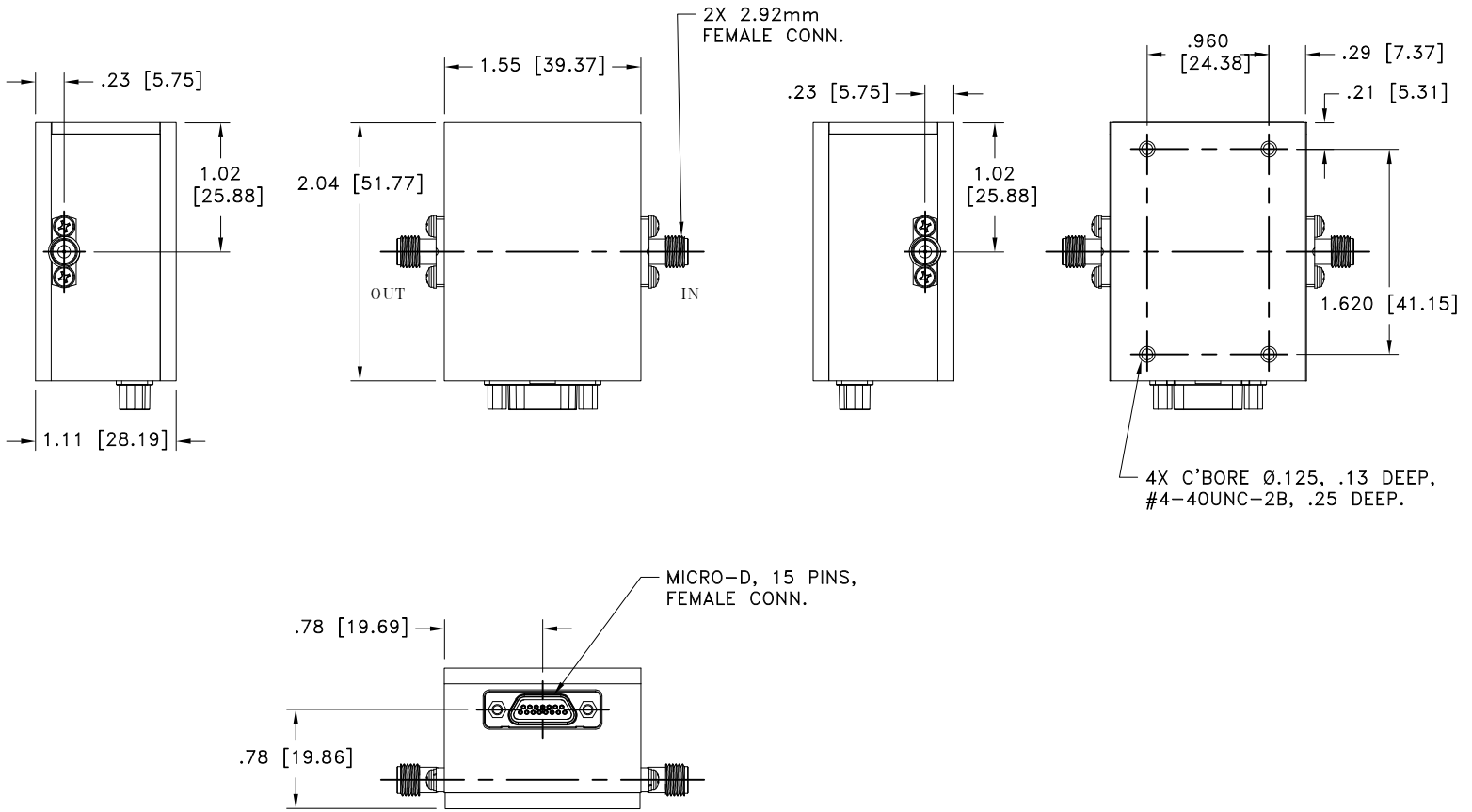

Weight: 6.5oz. (184 grams)

Dimensions are in inches [mm]. Tolerances: 2 Pl.±.03; 3 Pl. ±.015 Inch

Notes:

Case material: Aluminum.  
Case Finish: Gold plated.



P.O. Box 350166, Brooklyn, New York 11235-0003 (718) 934-4500 Fax (718) 332-4661 For detailed performance specs & shopping online see Mini-Circuits web site



The Design Engineers Search Engine Provides ACTUAL Data Instantly From MINI-CIRCUITS At: [www.minicircuits.com](http://www.minicircuits.com)

RF/IF MICROWAVE COMPONENTS

All Mini-Circuits products are manufactured under exacting quality assurance and control standards, and are capable of meeting published specifications after being subjected to any or all of the following physical and environmental test.

<b>Specification</b>	<b>Test/Inspection Condition</b>	<b>Reference/Spec</b>
Operating Temperature	-40° to +60° C Baseplate Temp	Individual Model Data Sheet
Storage Temperature	-40° to +85° C Ambient Environment	Individual Model Data Sheet
Burn-in	(DC on) 72 hours at 25°C	----
Thermal Shock	-40° C to +85°C, 100 cycles	Transition time = 5 mins, Dwell time = 30 mins
Vibration	Random Vibration (non-operating)	MIL-STD-883K, Method 2025, Cond. 1A