



LOW NOISE, HIGH GAIN

# Wideband Amplifier **ZVA-18403G+** **ZVA-18403GX+**

50Ω 18 to 40 GHz

## THE BIG DEAL

- Extremely Low Noise Figure of 3.8 dB typ. through Ka-Band
- High Gain of 43 dB typ.
- Output Power, +23 dBm (200 mW)
- Available with and without heatsink
- Operates with a single DC supply of +9 to +15 V
- Over-Voltage and Reverse Voltage protected



Generic photo used for illustration purposes only

## APPLICATIONS

- 5G (24-39 GHz)
- Test and Instrumentation
- Ka band

Model No.	ZVA-18403G+	ZVA-18403GX+ <sup>3</sup>
Case Style	T2704	
Connectors	2.92mm Female	

### +RoHS Compliant

The +Suffix identifies RoHS Compliance. See our web site for RoHS Compliance methodologies and qualifications

## PRODUCT OVERVIEW

Mini-Circuits' ZVA-18403G+ is a coaxial, low noise, wideband and high gain amplifier operating from 18 to 40 GHz. The model operates over a single positive supply range of +9 to +15 V, allowing users to choose their desired operating voltage. Internal DC-DC conversion circuitry maintains constant efficiency over the full input voltage range. The amplifier incorporates several DC-protection features against over-voltage, reverse voltage and in-rush current that protects it from damage if mishandled during operation. This amplifier has an excellent Noise Figure performance of 3.8 dB (typ.) over the entire band, and is capable of delivering about 200 mW (+23 dBm) of RF Power. This amplifier is an ideal choice for applications with extremely demanding dynamic range requirements.

## KEY FEATURES

Feature	Advantages
Wide-band Amplifier, 18 to 40 GHz	A single amplifier serves the need for applications including 5G bands (24 to 39 GHz), SATCOM, Test & Instrumentation etc.
<ul style="list-style-type: none"> <li>• High Gain</li> <li>• Low Noise</li> <li>• Medium RF power</li> </ul>	The Amplifier is capable of providing high gain of over 43 dB (typ.) in the entire operating band with extremely Low noise of 3.8 dB (typ.) and good RF power of about +23 dBm.
Adjustable DC Supply Voltage	The device is capable of operating from +9 to +15 V with consistent DC power consumption
DC Protection – <ul style="list-style-type: none"> <li>• Over-voltage</li> <li>• Reverse voltage</li> <li>• In-rush current</li> </ul>	The internal DC circuitry allows the amplifier to be protected from external mishandling that could lead to catastrophic failures in the field.

REV. A  
 ECO-008345  
 ZVA-18403G+  
 DF/CP/PS  
 210618





LOW NOISE, HIGH GAIN

# Wideband Amplifier **ZVA-18403G+** **ZVA-18403GX+**

Mini-Circuits

## ELECTRICAL SPECIFICATIONS AT 25°C

Parameter	Condition (MHz)	ZVA-18403G+ ZVA-18403GX+ <sup>3</sup>			Units
		Min.	Typ.	Max.	
Frequency Range		18000		40000	MHz
Gain	18000-40000	38	43		dB
Noise Figure	18000-40000	—	3.8	4.8	dB
Output Power at 1 dB compression	18000-24000		21		dBm
	24000-40000		23		
Output third order intercept point <sup>4</sup>	18000-40000		28		dBm
Input VSWR	18000-18500		1.8		:1
	18500-23000		1.25		
	23000-40000		1.6		
Output VSWR <sup>2</sup>	18000-20000		1.5		:1
	20000-32000		2.6		
	30000-40000		2.4		
Operating DC Voltage		+9	—	+15	V
Device Operating Current <sup>1</sup> (at 9 V DC)		—	—	375	mA
Device Operating Power at Operating DC Voltage		—	3	—	W

1. DC Supply must be able to source at least 400 mA DC at startup.

2. Open and short-circuit loads are not recommended at the amplifier output. Ensure proper 50 Ohm load before turning the amplifier "ON".

3. For units without heat-sink, limit the maximum baseplate temperature to 85 °C.

4. Output IP3 is measured with two tones separated by 1 MHz, with output power at 14 dBm/tone.

## MAXIMUM RATINGS<sup>5</sup>

Parameter	Ratings
Operating Temperature	ZVA-18403G+ -40 °C to 70 °C Ambient ZVA-18403GX+ -40 °C to 85 °C Baseplate
Storage Temperature	-55 °C to 100 °C
Total Power dissipation	3.8 W
Input Power (CW)	+5 dBm
DC Operating Voltage	+16 V

5. Permanent damage may occur if any of these limits are exceeded.





LOW NOISE, HIGH GAIN

# Wideband Amplifier

# ZVA-18403G+ ZVA-18403GX+

## OUTLINE DRAWING

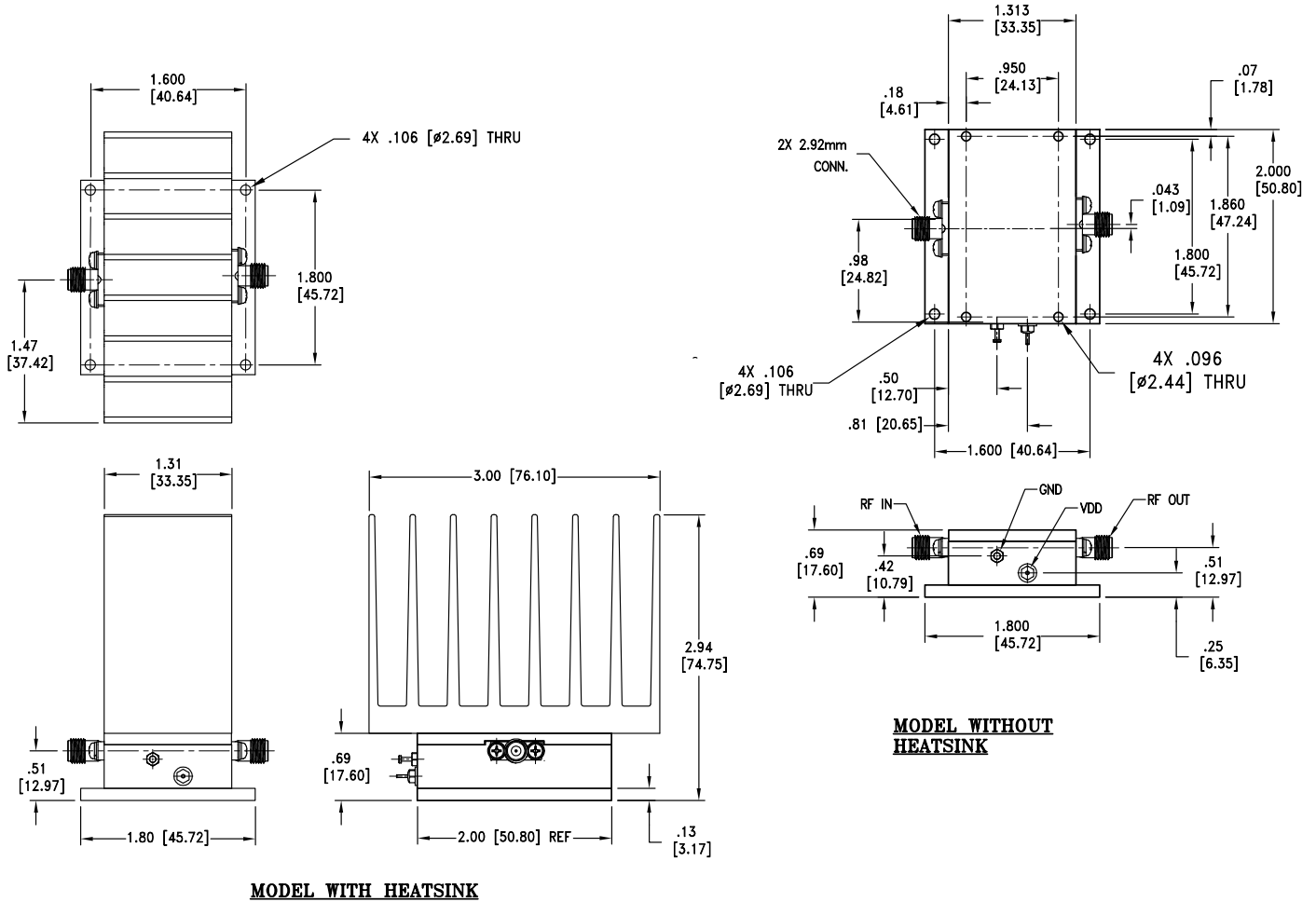

Weight: 350 grams; Weight without heatsink: 220 grams

Dimensions are in inches [mm] . Tolerances: 2 Pl.±.03; 3 Pl. ± .015



LOW NOISE, HIGH GAIN

# Wideband Amplifier ZVA-18403G+ ZVA-18403GX+

## TYPICAL PERFORMANCE DATA/CURVES

Frequency (MHz)	Gain (dB)	Directivity (dB)	VSWR (:1)		Noise Figure (dB)	Pout at 1 dB Compr. (dBm)	OIP3 (dBm)
	15 V	15 V	IN	OUT	15 V	15 V	15 V
18000	43.84	55.82	1.95	1.31	3.97	21.68	26.99
20000	43.93	60.30	1.25	1.48	3.76	22.06	27.71
22000	43.81	67.88	1.34	2.51	3.92	21.89	30.54
24000	43.57	69.86	1.73	3.21	4.06	23.40	28.97
26000	43.34	58.80	1.79	2.64	3.96	23.44	29.23
28000	43.76	53.01	1.83	2.77	3.92	21.95	28.05
30000	44.49	69.26	1.91	3.13	3.97	24.28	28.63
32000	45.22	47.89	1.75	2.33	3.66	23.54	26.90
34000	44.28	46.79	1.18	1.73	3.59	23.70	26.36
36000	42.86	54.59	1.38	1.87	3.61	23.65	27.40
38000	42.46	54.79	1.46	2.14	3.67	23.21	29.33
40000	43.75	49.69	1.93	2.49	3.91	22.62	27.23

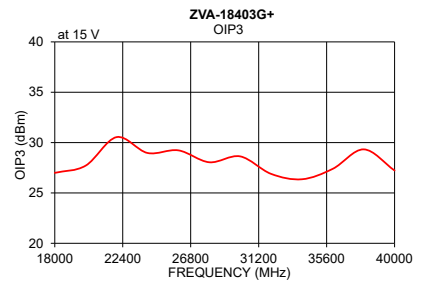
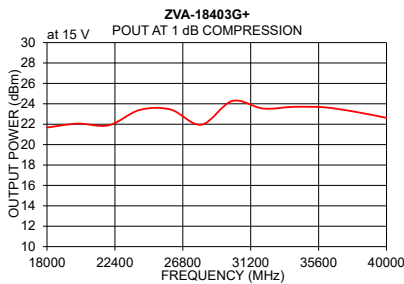
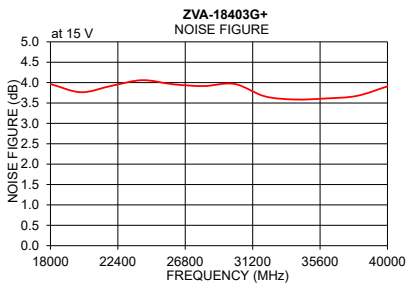
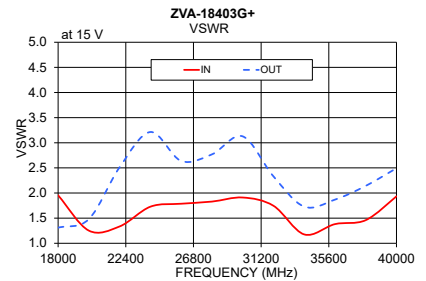
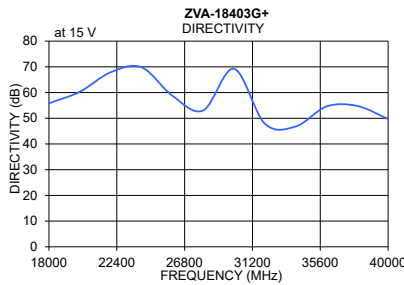
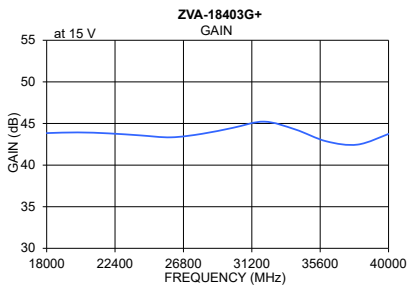

### NOTES

- A. Performance and quality attributes and conditions not expressly stated in this specification document are intended to be excluded and do not form a part of this specification document.
- B. Electrical specifications and performance data contained in this specification document are based on Mini-Circuit's applicable established test performance criteria and measurement instructions.
- C. The parts covered by this specification document are subject to Mini-Circuits standard limited warranty and terms and conditions (collectively, "Standard Terms"); Purchasers of this part are entitled to the rights and benefits contained therein. For a full statement of the standard. Terms and the exclusive rights and remedies thereunder, please visit Mini-Circuits' website at [www.minicircuits.com/MCLStore/terms.jsp](http://www.minicircuits.com/MCLStore/terms.jsp)



# Coaxial Amplifier

# ZVA-18403G+

## Typical Performance Data

FREQ. (MHz)	GAIN (dB) 15V	DIRECTIVITY (dB) 15V	VSWR (:1)		NOISE FIGURE (dB) 15V	POUT @ 1 dB COMPRESSION (dBm) 15V	OUTPUT IP3 (dBm) 15V
			IN 15V	OUT 15V			
18000	43.84	55.82	1.95	1.31	3.97	21.68	26.99
18500	43.96	66.51	1.52	1.29	3.89	21.59	26.53
19000	43.95	67.08	1.29	1.33	3.80	21.93	26.63
19500	43.92	63.37	1.24	1.40	3.71	21.94	27.46
20000	43.93	60.30	1.25	1.48	3.76	22.06	27.71
20500	43.94	58.11	1.24	1.61	3.82	21.53	27.67
21000	43.95	59.47	1.20	1.80	3.88	21.38	29.99
21500	43.91	73.27	1.21	2.13	3.88	21.21	30.31
22000	43.81	67.88	1.34	2.51	3.92	21.89	30.54
22500	43.65	63.47	1.50	2.91	4.00	22.68	30.83
23000	43.57	59.88	1.64	3.25	3.96	23.01	29.89
23500	43.53	62.18	1.71	3.34	4.05	23.51	29.82
24000	43.57	69.86	1.73	3.21	4.06	23.40	28.97
24500	43.66	70.91	1.69	2.93	4.02	23.46	28.54
25000	43.67	60.98	1.69	2.66	4.05	23.24	28.45
25500	43.56	62.03	1.73	2.52	4.04	22.77	28.85
26000	43.34	58.80	1.79	2.64	3.96	23.44	29.23
26500	43.14	64.57	1.86	2.82	4.00	22.46	29.58
27000	43.12	49.46	1.86	2.98	3.95	22.76	29.59
27500	43.33	65.49	1.84	2.96	4.00	22.61	28.89
28000	43.76	53.01	1.83	2.77	3.92	21.95	28.05
28500	44.19	58.71	1.83	2.51	3.95	22.89	28.34
29000	44.49	58.19	1.83	2.49	3.89	22.41	28.90
29500	44.54	52.71	1.88	2.76	4.01	23.00	28.97
30000	44.49	69.26	1.91	3.13	3.97	24.28	28.63
30500	44.51	56.44	1.93	3.41	3.89	23.83	28.37
31000	44.71	50.13	1.89	3.29	3.88	24.38	27.57
31500	45.01	51.48	1.84	2.84	3.82	23.47	26.42
32000	45.22	47.89	1.75	2.33	3.66	23.54	26.90
32500	45.20	50.73	1.62	1.94	3.70	23.52	27.20
33000	44.96	49.66	1.49	1.74	3.63	23.26	27.10
33500	44.60	42.95	1.33	1.69	3.62	23.06	26.90
34000	44.28	46.79	1.18	1.73	3.59	23.70	26.36
34500	44.00	46.39	1.10	1.78	3.61	23.45	26.27
35000	43.69	52.64	1.18	1.80	3.53	22.67	26.47
35500	43.29	46.79	1.30	1.84	3.61	23.39	27.18
36000	42.86	54.59	1.38	1.87	3.61	23.65	27.40
36500	42.47	47.60	1.43	1.89	3.57	23.29	27.66
37000	42.26	56.82	1.43	1.96	3.58	23.11	28.06
37500	42.29	54.30	1.42	2.02	3.68	23.19	28.71
38000	42.46	54.79	1.46	2.14	3.67	23.21	29.33
38500	42.68	64.07	1.53	2.26	3.78	22.95	28.79
39000	42.92	43.89	1.67	2.36	3.82	22.63	28.75
39500	43.26	41.67	1.86	2.38	3.89	22.67	27.69
40000	43.75	49.69	1.93	2.49	3.91	22.62	27.23

## Typical Performance Curves

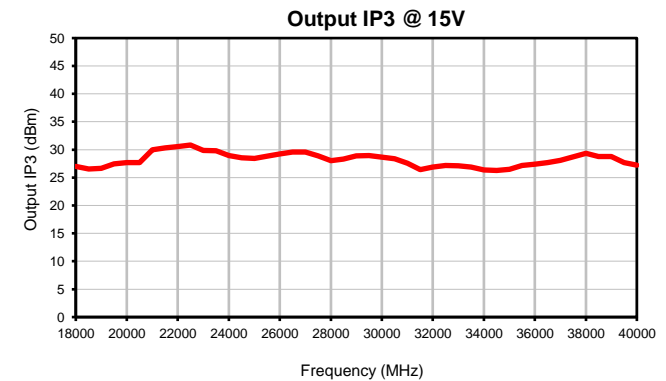
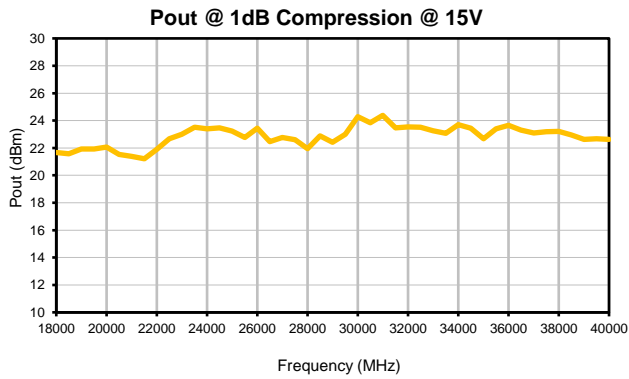
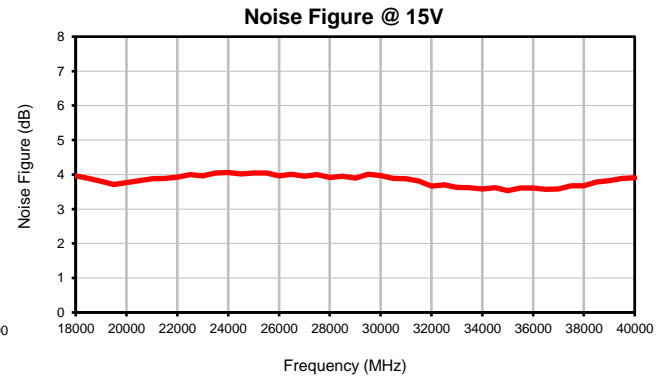
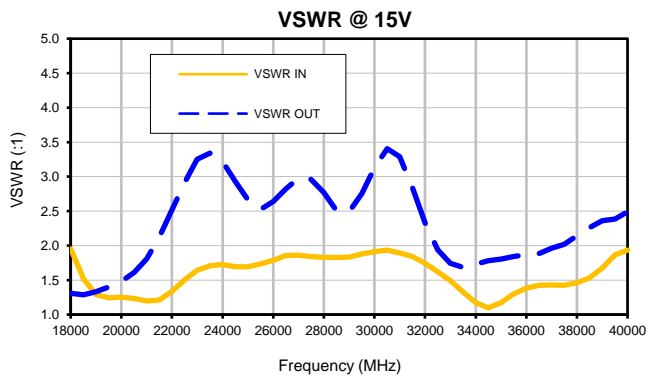
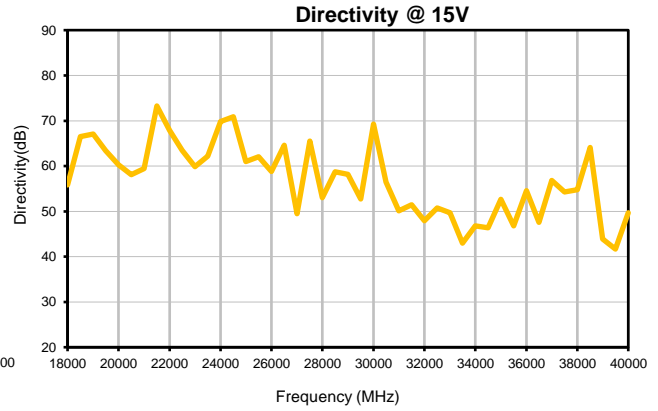
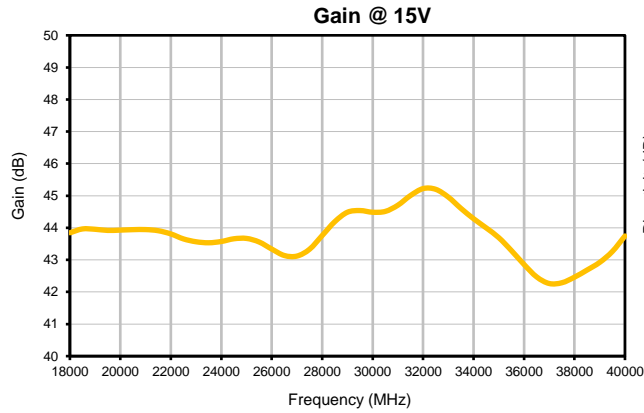

# Case Style

# T

## Outline Dimensions

### T2704

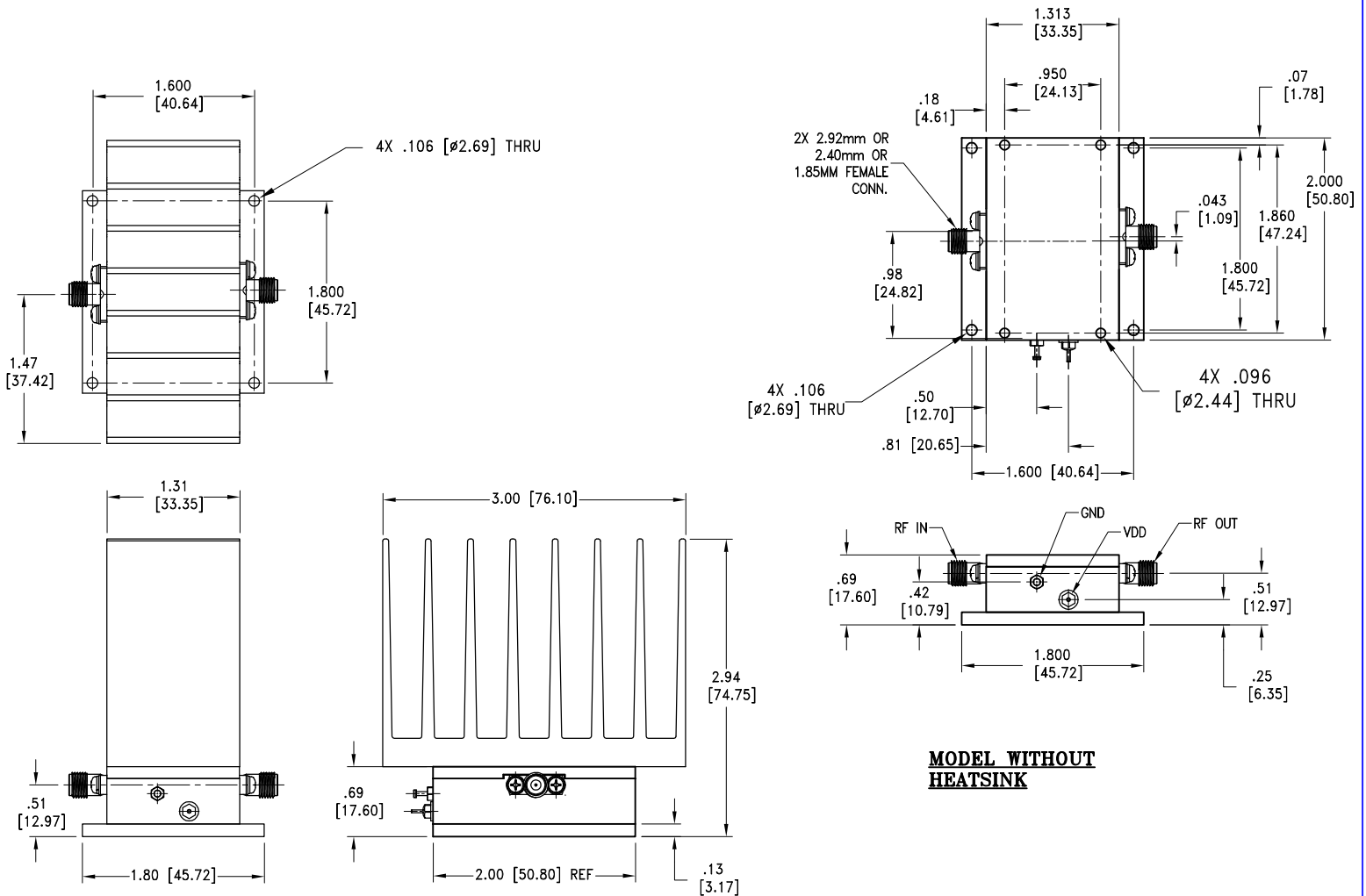

**MODEL WITH HEATSINK**

**MODEL WITHOUT HEATSINK**

Weight: 350 grams; Weight without heatsink: 220 grams

Dimensions are in inches (mm). Tolerances: 2 Pl.±.03; 3 Pl. ± .015

### Notes:

1. Case Material: Brass Alloy
2. Case Finish: Gold Plating
3. Heat sink finish: Black anodize.

**Mini-Circuits**  
ISO 9001 ISO 14001 CERTIFIED

ALL NEW  
minicircuits.com

P.O. Box 350166, Brooklyn, New York 11235-0003 (718) 934-4500 Fax (718) 332-4661 For detailed performance specs & shopping online see Mini-Circuits web site



The Design Engineers Search Engine Provides ACTUAL Data Instantly From MINI-CIRCUITS At: [www.minicircuits.com](http://www.minicircuits.com)

RF/IF MICROWAVE COMPONENTS



All Mini-Circuits products are manufactured under exacting quality assurance and control standards, and are capable of meeting published specifications after being subjected to any or all of the following physical and environmental test.

Specification	Test/Inspection Condition	Reference/Spec
Operating Temperature	-40° to 85° C Baseplate temp	Individual Model Data Sheet
Storage Temperature	-55° to 100° C Ambient Environment	Individual Model Data Sheet
Stabilization Bake	(non-operating) 125°C, 24 hours	---
Burn-in at Elevated Temp.	(DC on) 72 hours at 85° C	----
Thermal Shock	-40° C to +85°C, 100 cycles	Transition time = 5 mins, Dwell time = 30 mins