



# Mechanical Switch ZTRC-8SPDT-A18

50 Ω DC to 18 GHz 8 x SPDT Rack-Mount SMA Female

### THE BIG DEAL

- 8 x mechanical SPDT absorptive switches
- Convenient rack-mountable chassis
- Ethernet & USB control
- Fail-safe / redundancy switching
- LED switch state indicators



Generic photo used for illustration purposes only

### APPLICATIONS

- Benchtop and rack-mounted automated test systems
- 5G FR1, WiFi 6E, UWB, Bluetooth
- Military radio, radar & electronic warfare
- Switch matrices

### FUNCTIONAL BLOCK DIAGRAM

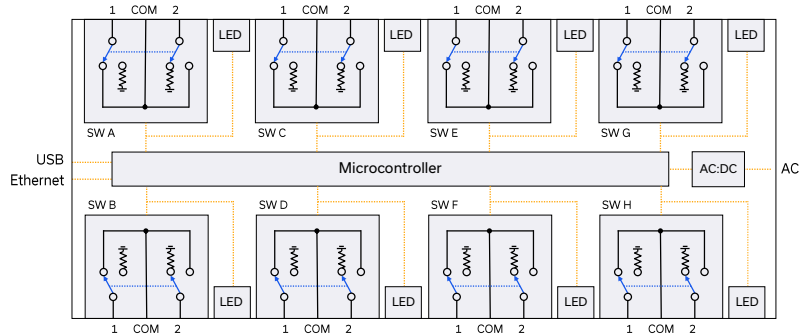

### PRODUCT OVERVIEW

Mini-Circuits' ZTRC-8SPDT-A18 houses 8 independently controlled electro-mechanical SPDT switches. Each switch operates over an extremely wide bandwidth, from DC to 18 GHz with high isolation and low insertion loss. The absorptive switches are failsafe, with a break before make configuration, and lifetime of 10 million switching cycles when used within the noted specifications.

The switches are housed in a compact 19-inch rack chassis, 2U height, with all SMA (female) RF connectors on the front. LED switch state indicators on the front panel enable visual display of all switch states. The switch assembly can be controlled via USB or Ethernet (supporting SSH, HTTP and Telnet network protocols). Full software support is provided, including our user-friendly GUI application for Windows and a full API with programming instructions for Windows and Linux environments.

### KEY FEATURES

Feature	Advantages
Mechanical switches	Mechanical absorptive switches provide low loss, high isolation, high reliability, repeatable performance and internal termination of input signals on the disconnected paths
Fail-safe design	The switches revert to a known default state when the DC supply is removed, allowing their use in systems that must continue to operate safely in the event of power failure
Break-before-make configuration	Prevents a momentary connection of the old and new signal paths, reducing the inconsistent transient effects that could otherwise be observed during switching
Rack-mount chassis	Compact 2U height, 19" rack-mountable chassis suits integration in automated production test environments.
Ethernet & USB control	USB HID and Ethernet (SSH, HTTP & Telnet) interfaces ensure compatibility with most software environments and connection requirements.

REV. D  
ECO-018908  
ZTRC-8SPDT-A18  
MCL NY  
231204



# Mechanical Switch **ZTRC-8SPDT-A18**

**ELECTRICAL SPECIFICATIONS AT +25°C (EACH SWITCH)**

Parameter	Conditions	Min.	Typ.	Max.	Units
Frequency Range	-	DC		18	GHz
Insertion Loss	DC - 8 GHz		0.15	0.30	dB
	8 - 12 GHz		0.25	0.40	
	12 - 18 GHz		0.30	0.50	
Isolation (Inactive Paths) <sup>1</sup>	DC - 8 GHz	75	90		dB
	8 - 12 GHz	70	80		
	12 - 18 GHz	60	66		
Return Loss <sup>2</sup>	DC - 8 GHz		20		dB
	8 - 12 GHz		20		
	12 - 18 GHz		19		
Switching Time			25		ms
RF Input Power (Cold Switching)	DC-18 GHz			20	W
	Into internal termination			1	
Switch Lifetime	100 mW hot switching <sup>3</sup>		10		million cycles
	1W hot switching		1		

1. Isolation measured between Com and any disconnected port. Example: Isolation for Com to 1 is the leakage measured at port 1 from a signal input at Com when the active switch path is set to Com to 2.

2. Return loss into all ports in all states

3. Hot switching power above this level will degrade the switch lifetime



## CONTROL INTERFACES

Ethernet Control	Supported Protocols	TCP / IP, SSH, HTTP, Telnet, DHCP, UDP (limited)
	Max Data Rate	100 Mbps (100 Base-T Full Duplex)
USB Control	Supported Protocols	HID – High Speed
	Min Communication Time <sup>1</sup>	400 μs typ

1. Based on the polling interval of the USB HID protocol (125 μs with 64 bytes per packet) and no other significant CPU or USB activity

## SOFTWARE & DOCUMENTATION

Mini-Circuits' full software and support package including user guide, Windows GUI, API, programming manual and examples can be downloaded free of charge (refer to the last page for the download path).

A comprehensive set of software control options is provided:

- GUI for Windows – Simple software interface for control via Ethernet and USB
- Programming / automation via Ethernet
  - Complete set of control commands which can be sent via any supported protocol – simple to implement in the majority of modern programming environments
- Programming / automation via USB
  - DLL files provide a full API for Windows with a set of intuitive functions which can be implemented in any programming environment supporting .Net Framework or ActiveX
  - Direct USB programming is possible in any other environment (not supporting .Net or ActiveX)

Please contact [testsolutions@minicircuits.com](mailto:testsolutions@minicircuits.com) for support

## MINIMUM SYSTEM REQUIREMENTS

Hardware	Intel i3 (or equivalent) or later
GUI (USB or Ethernet Control)	Windows 7 or later
USB API DLL	Windows 7 or later with support for Microsoft .Net Framework or ActiveX
USB Direct Programming	Windows 7 or later; Linux
Ethernet	Windows, Linux or macOS with Ethernet TCP / IP support

## PROGRAMMING COMMANDS

The key ASCII / SCPI commands for control of the system for control via the Ethernet or USB API are summarized below (refer to the programming manual for full details):

Command / Query	Description
:MN?	Read model name
:SN?	Read serial number
:FIRMWARE?	Read firmware version
SET[sw_label]=[port]	Set a single switch state: <ul style="list-style-type: none"> <li>• [sw_label] = A to H</li> <li>• [port] = 0 (Com to 1) or 1 (Com to 2)</li> <li>• Example: SETA=1 (set SPDT A with Com to 2)</li> </ul>
SWPORT?	Get the state of all switches: <ul style="list-style-type: none"> <li>• Returns a byte value, with the 2 least significant bits each representing the state of an individual SPDT (switch A is the least significant bit). The value for each switch will be:</li> <li>• 0 = COM to 1</li> <li>• 1 = COM to 2</li> <li>• Example: A returned value of 2 is represented as 00000010 indicating SW B = 1 (Com to 2) &amp; SW A = 0 (Com to 1)</li> </ul>



# Mechanical Switch ZTRC-8SPDT-A18

50 Ω DC to 18 GHz 8 x SPDT Rack-Mount SMA Female

## GRAPHICAL USER INTERFACE (GUI) FOR WINDOWS - KEY FEATURES

- Connect via USB or Ethernet
- Run GUI in "demo mode" to evaluate software without a hardware connection

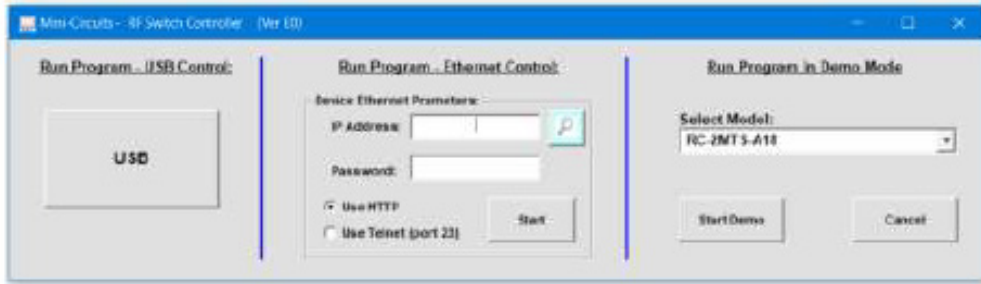

- View and set all switch states at the click of a button
- Set switch power-up states
- Configure Ethernet settings
- Update firmware

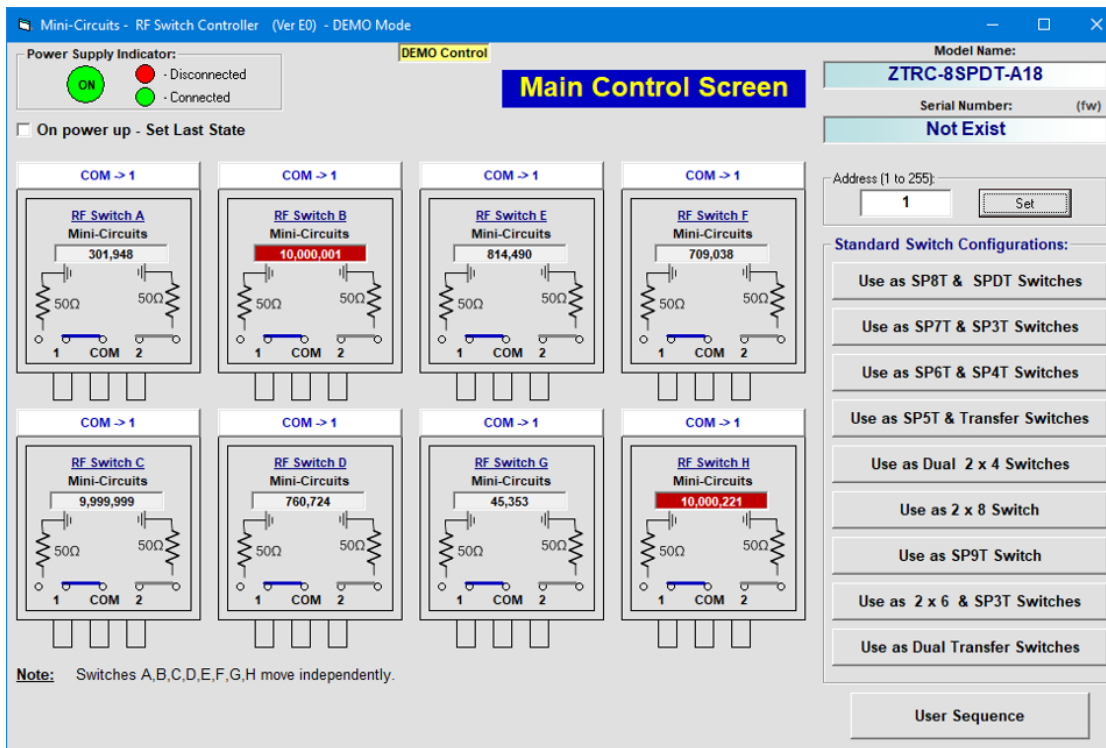



USB & ETHERNET

# Mechanical Switch ZTRC-8SPDT-A18

Mini-Circuits

50  $\Omega$  DC to 18 GHz 8 x SPDT Rack-Mount SMA Female

## TYPICAL PERFORMANCE CURVES

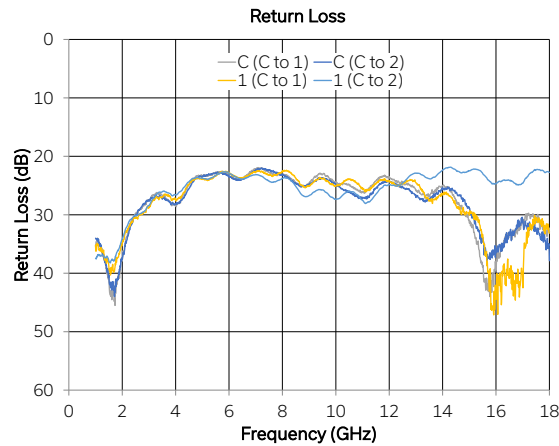
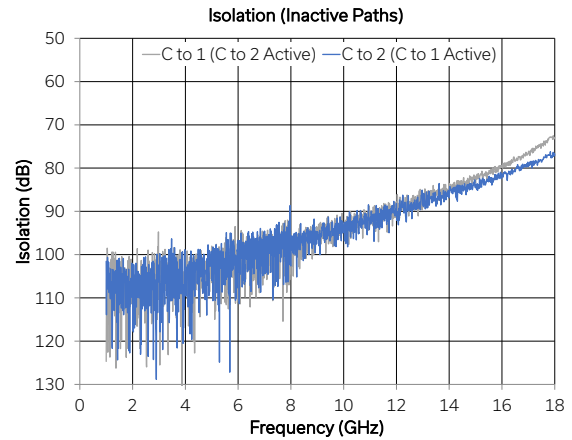
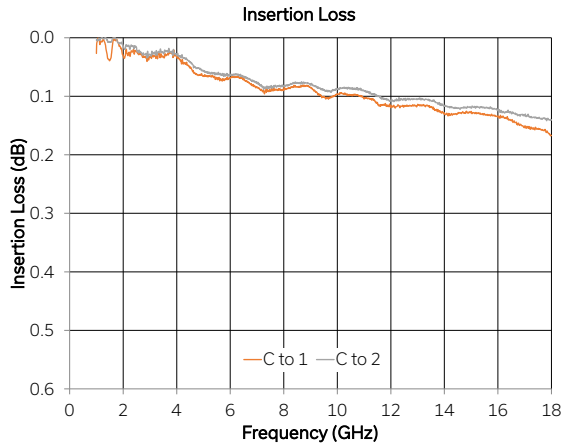



# Mechanical Switch ZTRC-8SPDT-A18

50 Ω DC to 18 GHz 8 x SPDT Rack-Mount SMA Female

### ABSOLUTE MAXIMUM RATINGS

Parameter	Conditions	Limits	Units
Temperature	Operating	0 to 70	°C
	Storage	-20 to 85	
Input Power (No Damage)	Cold switching	20	W
	Hot switching	1	
	Into internal termination	1	

Permanent damage may occur if any of these limits are exceeded. Operating in the range between operating power limits and absolute maximum ratings for extended periods of time may result in reduced life and reliability.

### POWER SUPPLY

Power Supply	AC mains input: 100-240 V, 50 / 60 Hz
Fuse	2A, 250V rating
Power Consumption	150W maximum

### FUNCTIONAL BLOCK DIAGRAM

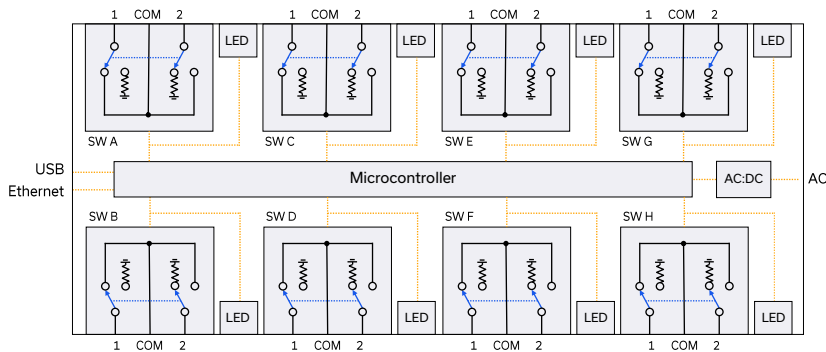

### CONNECTIONS

Port	Connector
C & 1-2 (each SPDT)	SMA female
USB	USB type B
Ethernet / LAN	RJ45
AC Input	IEC C14 inlet

C = Com port  
1-2 = input / output ports

### SWITCH STATE TABLES (EACH SPDT SWITCH)

Switch Command	Switch x State	Front Panel x LED Color
SET[x]=0	C to 1	Green
SET[x]=1	C to 2	Orange

x = switch label



USB & ETHERNET

# Mechanical Switch ZTRC-8SPDT-A18

50 Ω DC to 18 GHz 8 x SPDT Rack-Mount SMA Female

## CASE STYLE DRAWING

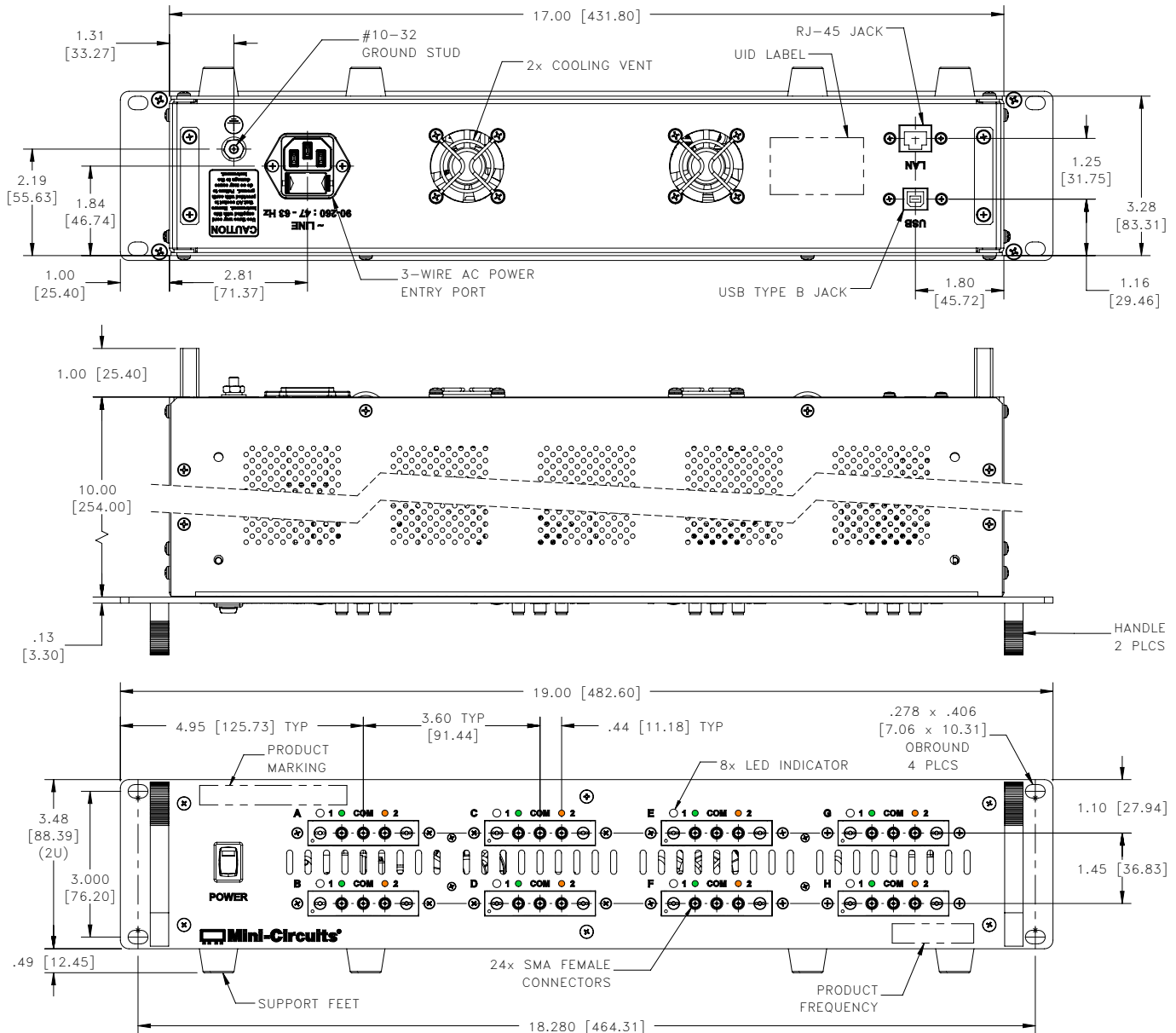

### Notes:

1. Case material: Aluminum (with protective coating to prevent corrosion).
2. Dimensions are in inches (mm). Tolerances: 2 Pl. ±.03 inch; 3 Pl. ±.015 inch.
3. Weight: 3350 grams.
4. Marking may contain other features or characters for internal lot control.

### PRODUCT MARKING\*

Product Marking: ZTRC-8SPDT-A18

Product Frequency: DC - 18 GHz

Unit ID Label: Serial number and other identification marks

\*Marking may contain other features or characters for internal lot control





USB & ETHERNET



# Mechanical Switch ZTRC-8SPDT-A18





50 Ω DC to 18 GHz 8 x SPDT Rack-Mount SMA Female

DETAILED MODEL INFORMATION IS AVAILABLE ON OUR WEBSITE [CLICK HERE](#)

Case Style	VD2683
Software, User Guide & Programming Manual	<a href="http://www.minicircuits.com/softwaredownload/rfswitchcontroller.html">www.minicircuits.com/softwaredownload/rfswitchcontroller.html</a>
Environmental Rating	ENV140
Regulatory Compliance	<p>Refer to our website for compliance methodologies and qualifications</p>  <p><a href="http://www.minicircuits.com/quality/environmental_introduction.html">www.minicircuits.com/quality/environmental_introduction.html</a></p>

Contact Us: [testsolutions@minicircuits.com](mailto:testsolutions@minicircuits.com)

Included Accessories	Part Number	Description
	CBL-3W-xx	AC power cord (IEC C13 connector to local plug) Select one option from the list below. Please contact <a href="mailto:testsolutions@minicircuits.com">testsolutions@minicircuits.com</a> if your region is not listed.
	USB-CBL-AB-7+	USB cable (6.8ft) type A to type B
	CBL-RJ45-MM-5+	Ethernet cable (5 ft)
	HT-4-SMA	SMA connector wrench (4" length)

AC Power Cord Options	Part Number	Description
	CBL-3W-US	USA NEMA 5-15 plug (type B) to IEC C13 connector
	CBL-3W-EU	Europe CEE 7/7 plug (type E/F) to IEC C13 connector
	CBL-3W-UK	UK BS-1363 plug (type G) to IEC C13 connector
	CBL-3W-AU	Australia & China AS/NZS 3112 plug (type I) to IEC C13 connector
	CBL-3W-IL	Israel SI-32 plug (type H) to IEC C13 connector

- NOTES**
- A. Performance and quality attributes and conditions not expressly stated in this specification document are intended to be excluded and do not form a part of this specification document.
  - B. Electrical specifications and performance data contained in this specification document are based on Mini-Circuit's applicable established test performance criteria and measurement instructions.
  - C. The parts covered by this specification document are subject to Mini-Circuits standard limited warranty and terms and conditions (collectively, "Standard Terms"); Purchasers of this part are entitled to the rights and benefits contained therein. For a full statement of the standard. Terms and the exclusive rights and remedies thereunder, please visit Mini-Circuits' website at [www.minicircuits.com/MCLStore/terms.jsp](http://www.minicircuits.com/MCLStore/terms.jsp)





# Rack-Mounted/USB & Ethernet Control RF SPDT Switch Matrix

# ZTRC-8SPDT-A18

## Typical Performance Data per Switch

FREQUENCY (MHz)	INSERTION LOSS ON (dB)		ISOLATION OFF (dB)		VSWR, IN (:1)		VSWR ENERGIZED (:1)		VSWR DE-ENERGIZED (:1)	
	IN-J1	IN-J2	IN-J1	IN-J2	ON	OFF	T1	J2	J1	T2
10	0.00	0.00	86.92	90.23	1.00	1.00	1.00	1.00	1.00	1.01
50	0.01	0.01	98.46	106.75	1.00	1.00	1.00	1.00	1.00	1.01
100	0.01	0.01	101.44	104.72	1.00	1.01	1.00	1.00	1.00	1.01
125	0.01	0.01	108.20	98.00	1.00	1.01	1.01	1.00	1.01	1.01
150	0.01	0.01	96.37	102.07	1.00	1.01	1.01	1.00	1.01	1.01
175	0.02	0.02	94.22	97.85	1.00	1.01	1.01	1.01	1.01	1.01
200	0.02	0.02	101.65	109.01	1.01	1.01	1.01	1.01	1.01	1.01
225	0.02	0.02	97.99	107.65	1.01	1.01	1.01	1.01	1.01	1.01
250	0.02	0.02	101.47	94.21	1.01	1.01	1.01	1.01	1.01	1.01
275	0.02	0.02	92.78	92.66	1.01	1.01	1.01	1.01	1.01	1.01
300	0.02	0.02	97.04	96.69	1.01	1.01	1.01	1.01	1.01	1.01
325	0.02	0.02	104.51	99.02	1.01	1.01	1.01	1.01	1.01	1.01
350	0.02	0.02	100.00	94.75	1.01	1.01	1.01	1.01	1.01	1.01
375	0.02	0.02	101.93	94.94	1.01	1.01	1.01	1.01	1.01	1.01
400	0.03	0.03	100.05	95.08	1.01	1.01	1.01	1.01	1.01	1.01
425	0.03	0.03	95.00	102.15	1.01	1.01	1.01	1.01	1.01	1.01
450	0.03	0.02	102.73	93.54	1.01	1.01	1.01	1.01	1.01	1.01
475	0.03	0.03	112.90	96.47	1.01	1.01	1.01	1.01	1.01	1.01
500	0.03	0.03	97.69	95.09	1.01	1.01	1.01	1.01	1.01	1.01
550	0.03	0.03	106.01	101.00	1.01	1.01	1.01	1.01	1.01	1.02
600	0.03	0.03	99.20	94.68	1.01	1.01	1.01	1.01	1.01	1.02
650	0.03	0.03	100.64	90.78	1.01	1.01	1.01	1.01	1.01	1.02
700	0.03	0.03	89.79	97.48	1.01	1.01	1.01	1.01	1.01	1.02
750	0.04	0.04	97.85	104.45	1.01	1.01	1.01	1.01	1.01	1.02
800	0.04	0.03	93.32	96.76	1.01	1.01	1.01	1.01	1.01	1.02
850	0.04	0.04	99.91	94.27	1.01	1.01	1.01	1.01	1.01	1.02
900	0.04	0.04	94.16	97.69	1.01	1.01	1.01	1.01	1.01	1.02
950	0.04	0.04	90.40	98.16	1.01	1.01	1.01	1.01	1.01	1.02
1000	0.04	0.04	102.68	97.93	1.01	1.01	1.01	1.01	1.01	1.02
1500	0.05	0.05	95.49	99.63	1.01	1.02	1.01	1.01	1.02	1.04
2000	0.06	0.06	100.29	89.71	1.02	1.03	1.02	1.02	1.03	1.05
2500	0.07	0.07	112.79	91.64	1.04	1.04	1.04	1.04	1.04	1.07
3000	0.08	0.07	99.44	94.36	1.06	1.06	1.06	1.06	1.06	1.08
3500	0.08	0.08	102.43	115.93	1.08	1.07	1.08	1.08	1.07	1.10
4000	0.09	0.08	93.35	96.55	1.09	1.09	1.09	1.10	1.09	1.11
4500	0.10	0.09	95.08	98.69	1.10	1.11	1.10	1.11	1.11	1.12
5000	0.11	0.10	92.98	90.42	1.12	1.13	1.12	1.12	1.12	1.13
5500	0.12	0.12	101.53	94.30	1.15	1.15	1.15	1.14	1.15	1.14
6000	0.13	0.11	98.44	94.76	1.16	1.18	1.18	1.18	1.18	1.14
6500	0.15	0.13	91.76	99.78	1.18	1.20	1.19	1.20	1.21	1.13
7000	0.15	0.14	104.93	92.46	1.18	1.21	1.19	1.20	1.21	1.12
7500	0.15	0.12	90.86	88.25	1.16	1.20	1.17	1.18	1.20	1.11
8000	0.14	0.14	105.64	91.48	1.14	1.17	1.15	1.14	1.17	1.09
8500	0.14	0.13	101.28	92.80	1.11	1.13	1.12	1.11	1.13	1.08
9000	0.14	0.13	100.36	91.51	1.09	1.09	1.10	1.08	1.09	1.06
9500	0.14	0.13	88.90	85.21	1.07	1.06	1.07	1.05	1.06	1.06
10000	0.14	0.13	92.35	89.45	1.04	1.04	1.05	1.04	1.04	1.06
10500	0.15	0.13	85.50	103.82	1.03	1.02	1.04	1.04	1.03	1.06
11000	0.16	0.14	91.02	91.97	1.04	1.04	1.05	1.06	1.04	1.07
11500	0.16	0.15	85.91	83.52	1.07	1.05	1.08	1.07	1.05	1.09
12000	0.17	0.16	98.57	78.50	1.10	1.08	1.10	1.09	1.08	1.12
12500	0.19	0.18	83.88	86.26	1.15	1.12	1.15	1.12	1.12	1.15
13000	0.20	0.19	82.82	89.80	1.19	1.17	1.17	1.17	1.18	1.20
13500	0.22	0.21	84.33	85.23	1.23	1.22	1.23	1.21	1.22	1.25
14000	0.25	0.22	84.16	89.36	1.27	1.26	1.27	1.26	1.27	1.30
14500	0.28	0.24	80.50	91.55	1.31	1.30	1.31	1.29	1.32	1.34
15000	0.30	0.25	84.72	83.73	1.32	1.32	1.31	1.29	1.32	1.37
15500	0.31	0.25	79.28	78.90	1.33	1.34	1.33	1.29	1.33	1.39
16000	0.32	0.25	80.73	79.61	1.31	1.32	1.32	1.28	1.31	1.37
16500	0.32	0.26	79.17	80.78	1.31	1.27	1.31	1.27	1.28	1.36
17000	0.30	0.25	77.82	81.23	1.30	1.23	1.27	1.21	1.21	1.33
17500	0.30	0.24	75.87	81.12	1.28	1.19	1.24	1.18	1.16	1.30
18000	0.31	0.26	76.06	78.10	1.27	1.17	1.26	1.19	1.15	1.29



# Rack-Mounted/USB & Ethernet Control RF SPDT Switch Matrix

# ZTRC-8SPDT-A18

## Typical Performance Curves per Switch

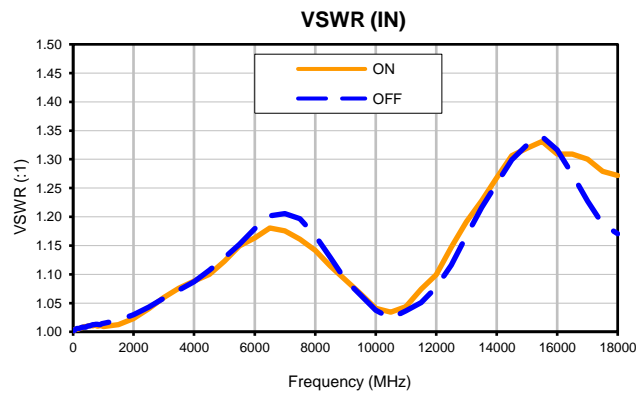
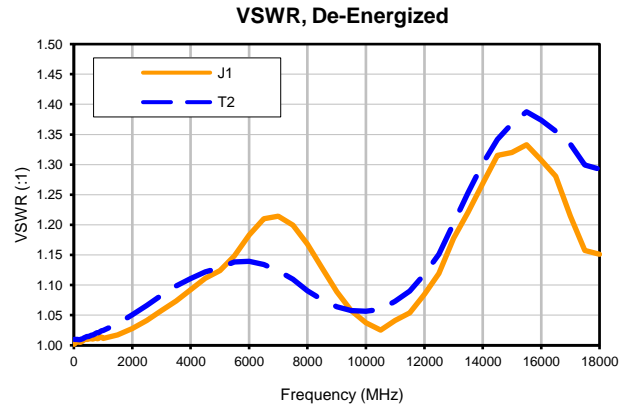
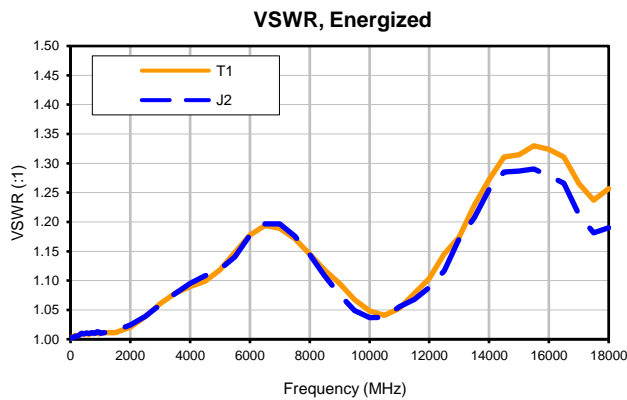
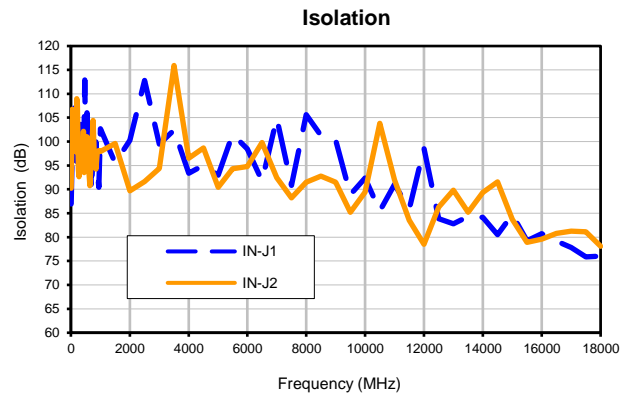
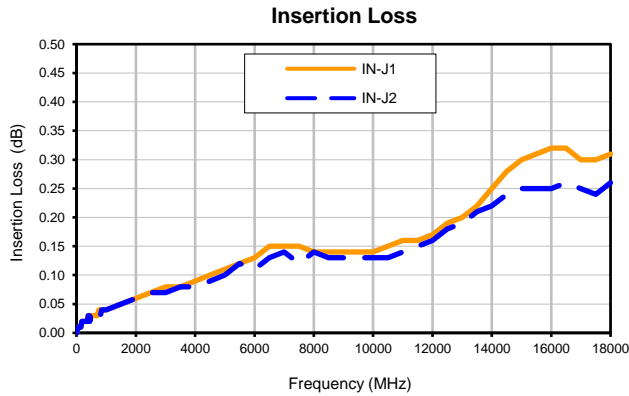

## Outline Dimensions

### VD2683

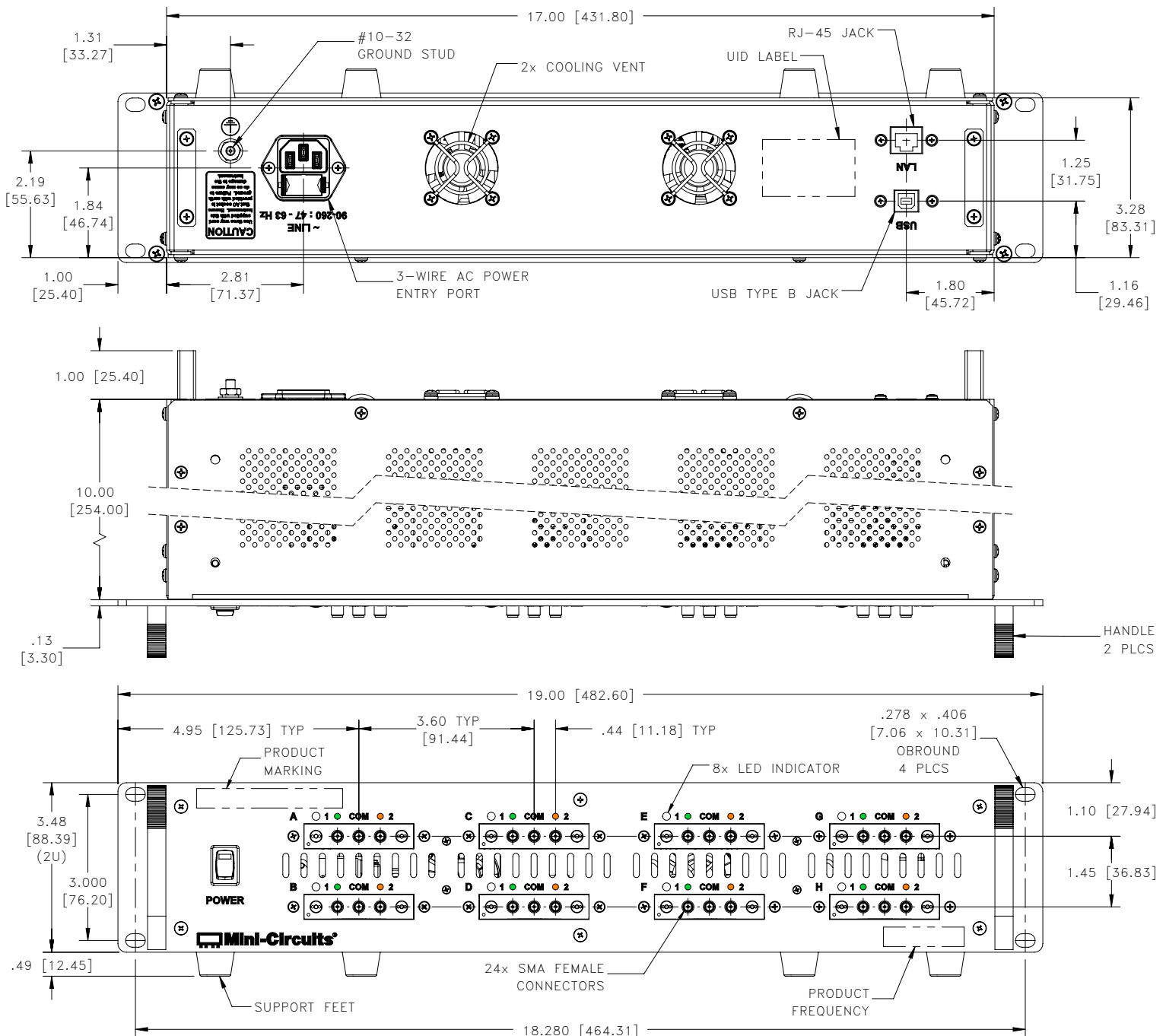

### Notes:

1. Case material: Aluminum (with protective coating to prevent corrosion).
2. Dimensions are in inches (mm). Tolerances: 2 Pl.  $\pm 0.03$  inch; 3 Pl.  $\pm 0.015$  inch.
3. Weight: 3350 grams.
4. Marking may contain other features or characters for internal lot control.



P.O. Box 350166, Brooklyn, New York 11235-0003 (718) 934-4500 Fax (718) 332-4661 For detailed performance specs & shopping online see Mini-Circuits web site



The Design Engineers Search Engine Provides ACTUAL Data Instantly From MINI-CIRCUITS At: [www.minicircuits.com](http://www.minicircuits.com)

RF/IF MICROWAVE COMPONENTS



All Mini-Circuits products are manufactured under exacting quality assurance and control standards, and are capable of meeting published specifications after being subjected to any or all of the following physical and environmental test.

Specification	Test/Inspection Condition	Reference/Spec
Operating Temperature	0° to 70° C Ambient Environment	Individual Model Data Sheet
Storage Temperature	-20° to 85° C Ambient Environment	Individual Model Data Sheet
Operating and Storage Humidity	5% to 85% RH (non-condensing)	Ambient
Bench Handling Test	Bench Top Tip 45° & Drop	MIL-PRF-28800F
Transit Drop Test	Free Fall Drop, 20 cm (7.9 inches)	MIL-PRF-28800F class 3