

RACK-MOUNTED

Adapter Patch Panel

ZT-396

50 Ω DC to 18 GHz 16 x SMA Female

THE BIG DEAL

- Rack-mounted connector patch panel
- 16 x SMA adapters in 1U rack space
- Excellent return loss
- Flat frequency response

APPLICATIONS

- Production test setups
- Simplification of cable runs
- Interconnection of RF cables & equipment

PRODUCT OVERVIEW

Mini-Circuits panel-mounted structures provide clean, organized management of cable runs and connections in complex, high volume test setups. Multiple connector adapters, power splitters, directional couplers and other essential RF components and test accessories can be integrated efficiently within the test system. Custom configurations are available upon request.

ZT-396 integrates 16 wideband adapters on to a compact panel requiring only 1U of rack space, with SMA female connectors on the front and rear.

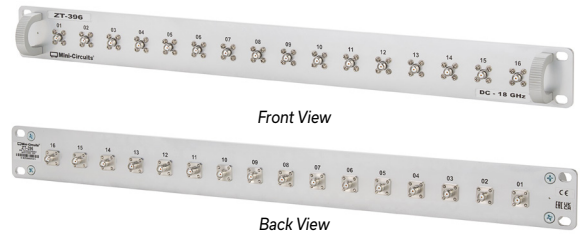

Generic photo used for illustration purposes only

ELECTRICAL SPECIFICATIONS AT +25°C (EACH ADAPTER)

Parameter	Conditions	Min.	Typ.	Max.	Units
Frequency Range		DC		18	GHz
Insertion Loss	DC - 18 GHz		0.1		dB
Return Loss	DC - 18 GHz	23			dB

TYPICAL PERFORMANCE GRAPHS

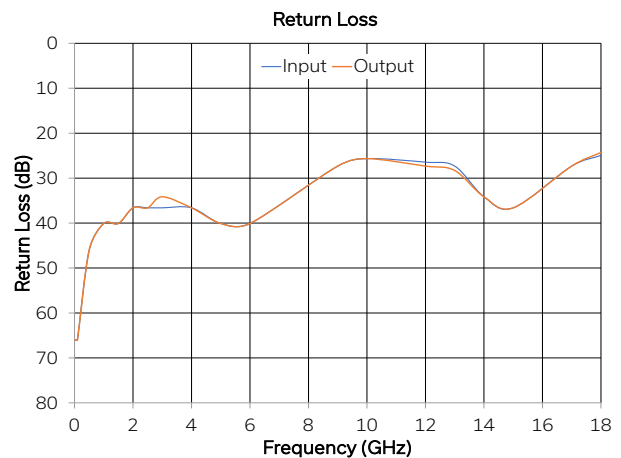
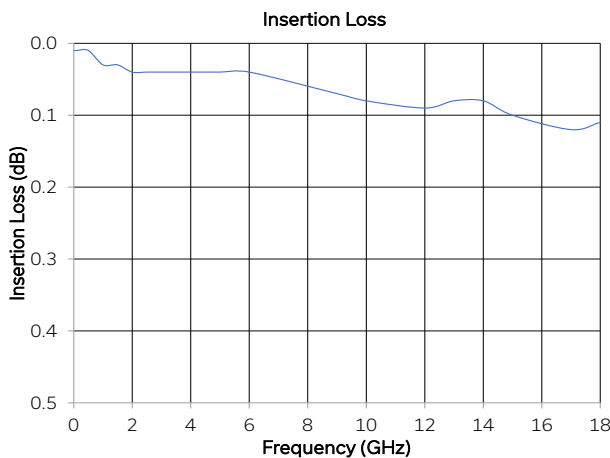

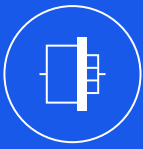

RACK-MOUNTED

Adapter Patch Panel

ZT-396

Mini-Circuits

50 Ω DC to 18 GHz 16 x SMA Female

CASE STYLE DRAWING

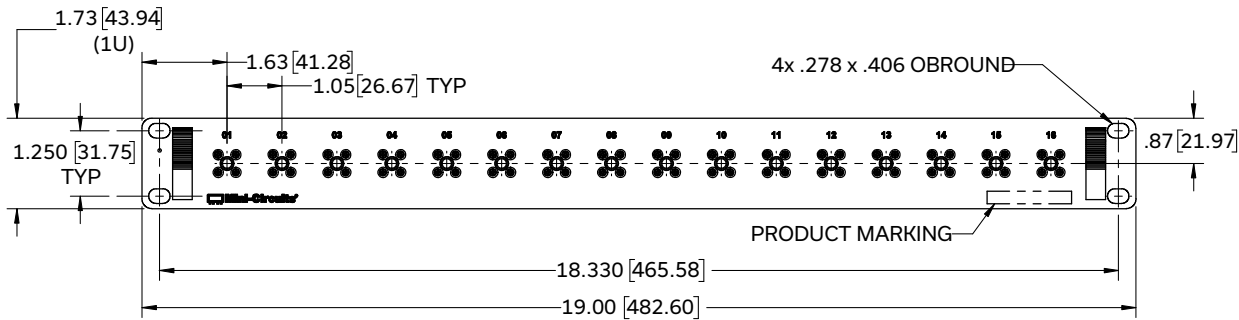
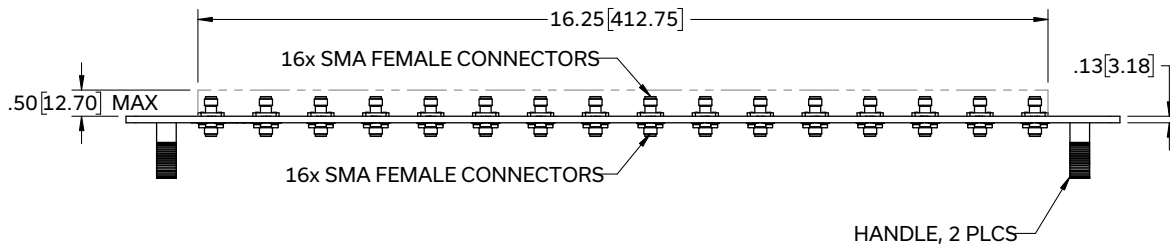
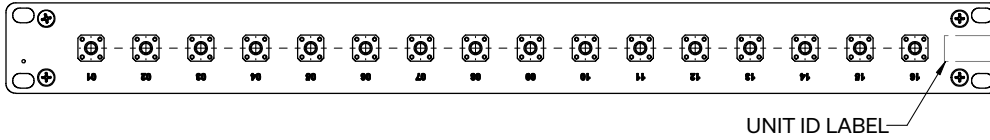

Weight: 280 grams.

Dimensions are in inches [mm]. Tolerances: 2 Pl. ±.03 inch; 3 Pl. ±.015 inch.

PRODUCT MARKING

Product Marking: ZT-396

Unit ID Label: Serial number and other identification marks

Marking may contain other features or characters for internal lot control



RACK-MOUNTED

Adapter Patch Panel

ZT-396

50 Ω DC to 18 GHz 16 x SMA Female

ABSOLUTE MAXIMUM RATINGS

Parameter	Conditions	Limits	Units
Temperature	Operating	0 to +50	°C
	Storage	-20 to +60	

Permanent damage may occur if any of these limits are exceeded. Operating in the range between operating power limits and absolute maximum ratings for extended periods of time may result in reduced life and reliability.

CONNECTIONS

Port	Connector
01-16 (front & rear)	SMA female

DETAILED MODEL INFORMATION IS AVAILABLE ON OUR WEBSITE [CLICK HERE](#)

Case Style	YF3460		
Environmental Rating	ENV55		
Regulatory Compliance	Refer to our website for compliance methodologies and qualifications 	www.minicircuits.com/quality/environmental_introduction.html	

Contact Us: testsolutions@minicircuits.com

Included Accessories	Part Number	Description
	HT-4-SMA	SMA connector wrench (4" length)

- NOTES**
- A. Performance and quality attributes and conditions not expressly stated in this specification document are intended to be excluded and do not form a part of this specification document.
 - B. Electrical specifications and performance data contained in this specification document are based on Mini-Circuit's applicable established test performance criteria and measurement instructions.
 - C. The parts covered by this specification document are subject to Mini-Circuits standard limited warranty and terms and conditions (collectively, "Standard Terms"); Purchasers of this part are entitled to the rights and benefits contained therein. For a full statement of the standard. Terms and the exclusive rights and remedies thereunder, please visit Mini-Circuits' website at www.minicircuits.com/MCLStore/terms.jsp

Outline Dimensions

YF3460

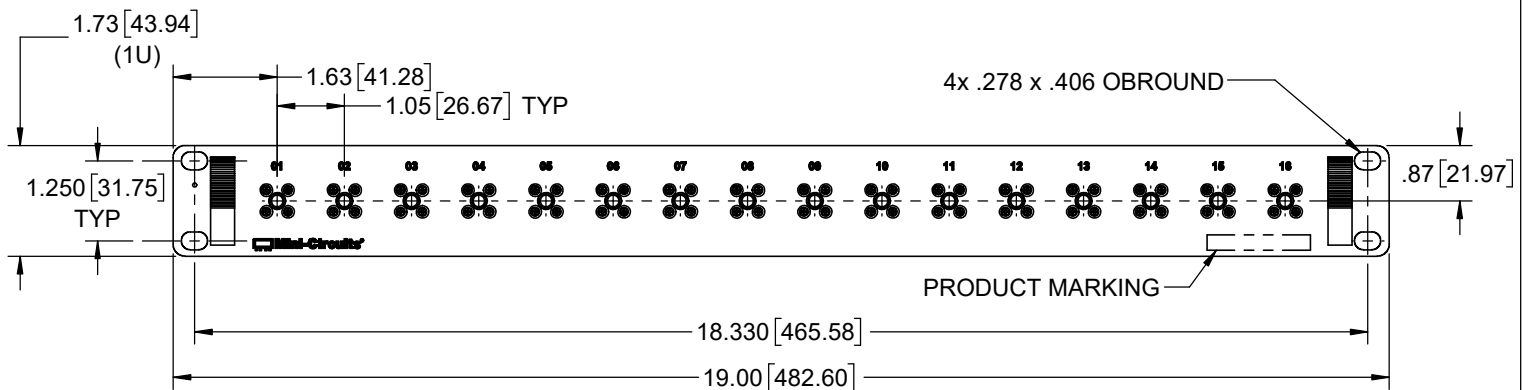
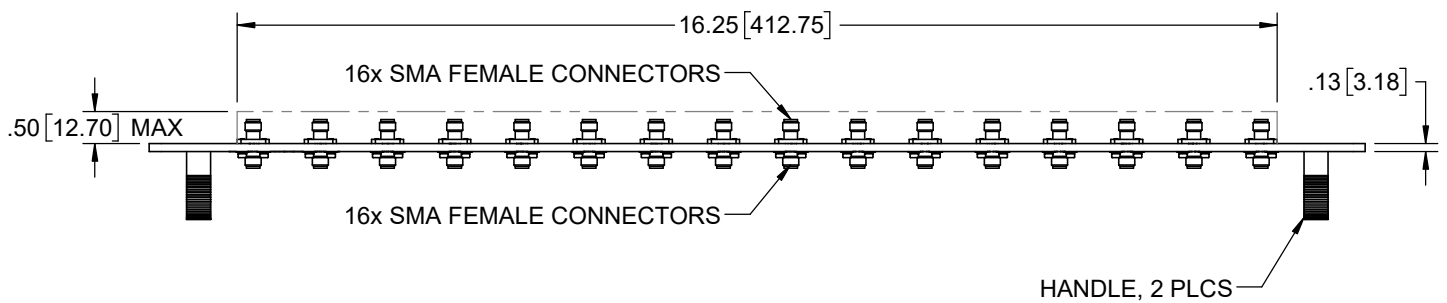
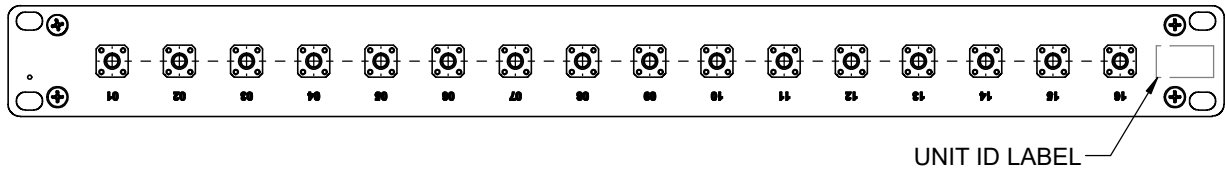

Notes:

1. Case material: Aluminum (with protective coating to prevent corrosion).
2. Dimensions are in inches (mm). Tolerances: 2 Pl. ± 0.03 inch; 3 Pl. ± 0.015 inch.
3. Weight: 280 grams.
4. Marking may contain other features or characters for internal lot control.

Mini-Circuits
ISO 9001 ISO 14001 CERTIFIED

ALL NEW
minicircuits.com

P.O. Box 350166, Brooklyn, New York 11235-0003 (718) 934-4500 Fax (718) 332-4661 For detailed performance specs & shopping online see Mini-Circuits web site



The Design Engineers Search Engine Provides ACTUAL Data Instantly From MINI-CIRCUITS At: www.minicircuits.com

RF/IF MICROWAVE COMPONENTS



Environmental Specifications **ENV55**

All Mini-Circuits products are manufactured under exacting quality assurance and control standards, and are capable of meeting published specifications after being subjected to any or all of the following physical and environmental test.

Specification	Test/Inspection Condition	Reference/Spec
Operating Temperature	-0° to 50° C Ambient Environment	Individual Model Data Sheet
Storage Temperature	-20° to 60° C Ambient Environment	Individual Model Data Sheet
Operating and Storage Humidity	5% to 85% RH (non-condensing)	Ambient
Bench Handling Test	Bench Top Tip 45° & Drop	MIL-PRF-28800F
Transit Drop Test	Free Fall Drop, 20 cm (7.9 inches)	MIL-PRF-28800F Class 3