

High Power, Solid state

SPDT RF Switch

ZSW2-63DR+

50 Ω Reflective RF switch 5 to 6000 MHz, 4 W
Internal driver, Single Supply Voltage 2.3V to 4.8V

The Big Deal

- Wide band, 5 to 6000 MHz
- High power +36 dBm
- High linearity, IP3 +73 dBm @ 850 MHz
- Low loss, 1.1 dB up to 6 GHz



Case Style: QV2426

Connectors	Order P/N
SMA	ZSW2-63DR+
	ZSW2-63DRB+ (with bracket)

Applications

- Lab
- Instrumentation
- Automatic Test equipment (ATE)
- Defense

+RoHS Compliant

The +Suffix identifies RoHS Compliance. See our web site for RoHS Compliance methodologies and qualifications

Product Overview

Mini-Circuits' ZSW2-63DR+ is a 50 Ω high power SPDT RF switch designed for automatic test equipment applications, covering a broad frequency range from 5 to 6000 MHz with low insertion loss and high linearity.

The ZSW2-63DR+ operates on a single supply voltage from +2.3 V to +4.8 V with a single pin control. The switch comes housed in a rugged, compact, aluminum alloy case (2.00 x 1.5 x 0.6") with 3 SMA-F connectors at RF ports and a 9-pin D-sub connector for DC power and control signals.

Key Features

Feature	Advantages
Wideband, 5 to 6000 MHz	One model can be used in many applications, saving component count. Also ideal for wideband applications such as military and instrumentation.
High linearity, + 73 dBm IP3	High linearity minimizes unwanted inter-modulation products which are difficult or impossible to filter in multi-carrier environments, or in the presence of strong interfering signal from adjacent circuitry or received by antenna.
Low insertion loss: <ul style="list-style-type: none">• 0.33 dB up to 1000 MHz• 1.1 dB up to 6000 MHz	Provides excellent transmission of signal power from input to output and minimizes overall system loss
High power: +36 dBm up to 6000 MHz	Suitable for signal routing applications with high power requirement such as antenna feeds in transmit systems and more.

RF Electrical Specifications: 5-6000 MHz, T_{AMB}=25°C, V_{DD}=+2.3V to +4.8V (unless noted otherwise)

Parameter	Port	Frequency	Min.	Typ.	Max.	Units
Operating Frequency	—	—	5	—	6000	MHz
Insertion Loss	RF COM to any active port	5-1000 MHz	—	0.33	0.7	dB
		1000-2500 MHz		0.6	0.9	
		2500-5000 MHz		0.9	1.4	
		5000-6000 MHz		1.1	1.5	
Isolation	between RF COM and RF1/RF2 ports	5-1000 MHz	39	48	—	dB
		1000-2500 MHz	30	37		
	between RF1 and RF2 ports	5-1000 MHz	40	51	—	dB
		1000-2500 MHz	30	40		
VSWR	RF COM port	5-1000 MHz	—	1.15	—	:1
		1000-2500 MHz		1.20		
	2500-5000 MHz	1.35				
	5000-6000 MHz	1.35				
RF1/RF2 ports	5-1000 MHz	1.15	—	1.15	—	:1
	1000-2500 MHz	1.20				
	2500-5000 MHz	1.30				
	5000-6000 MHz	1.30				
0.1dB Compression point ¹	RF COM to any active port	100-6000	—	35	—	dBm
IP2 ²	RF COM to any active port	850 MHz	—	115	—	dBm
		1800 MHz		115		
		2500 MHz		115		
IP3 ²	RF COM to any active port	850 MHz	—	73	—	dBm
		1800 MHz		74		
		2500 MHz		75		
Harmonics	—	850 MHz	—	-97	—	dBc
		1800 MHz		-97		
		2500 MHz		-90		
Operating RF input power ³	Through path	100-6000 MHz	—	—	+36	dBm

¹ 0.1 dB compression may degrade below 100 MHz to 31dBm at 5MHz.

² IP3 and IP2 tested with +25 dBm per tone. span between tones 45 MHz @ 850 MHz, 100 MHz @ 1800 & 2500 MHz.

³ For Max Power below 100 MHz See power derating curves on page 3.

DC Electrical Specifications

Parameter	Min.	Typ.	Max.	Units
V _{DD} , Supply Voltage	2.3	—	4.8	V
Supply Current ⁴	—	0.15	0.25	mA
Control Voltage Low	0	—	0.2xVDD (max 0.6V)	V
Control Voltage High	0.85xVDD	—	5.5	V
Control Current	—	40	—	μA

⁴ Supply current may reach 3mA at startup.

Switching Specifications

Parameter	Conditions	Min.	Typ.	Max.	Units	
Switching time 50% trigger to 10/90% signal level	On time	Pulse rate =125[kHz], RF freq. =501[MHz]	—	1.6	—	μs
	Off time		—	1.2	—	
Video feedthrough @ all ports	V _{ctrl} =0/3V, Duty Cycle= 50%	—	0.3	—	mVpp	

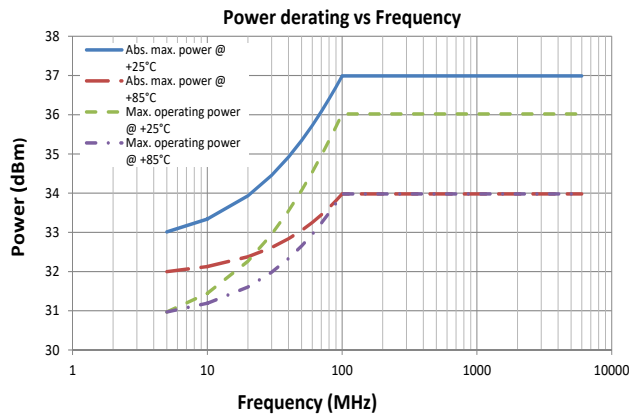

Absolute Maximum Ratings ^{5,6}

Parameter	Ratings
Operating Temperature, case	-40°C to +85°C
Storage Temperature	-55°C to +100°C
V _{dd} , Supply Voltage	-5V Min. 5V Max.
Control Voltage	-0.3V Min. 5.5V Max.
ESD, HBM	Class 1B (Pass 500V)
RF input power	See derating curves
DC voltage on RF pins	8V

5. Operation of this device above any of these conditions may cause permanent damage.
6. Operation in the range between the max operating power and the absolute maximum rating for extended periods of time may result in reduced life and reliability.

The RF switch control bit selects the desired switch-state, as shown in **Table 1: Truth Table**.

Table 1: Truth Table.

STATE	Control Input	RF Input / Output	
	Control V1	RF COM to RF2	RF COM to RF1
1	Low	OFF	ON
2	High	ON	OFF

Simplified Diagram

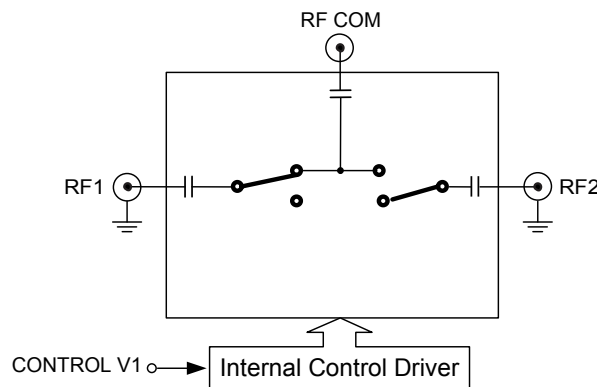

Connections

RF1	(SMA female)
RF2	(SMA female)
RF COM	(SMA female)
DC Supply and Control	9 Pin D-Sub female*

*9 Pin D-Sub Pin Connections

PIN Number	Function
3	V _{dd}
4	Not Connected
5	V1
1-2,6-9	GND ⁸

8. Only one of the GND pins is required to be connected for proper operation.

Outline Drawing (QV2426)

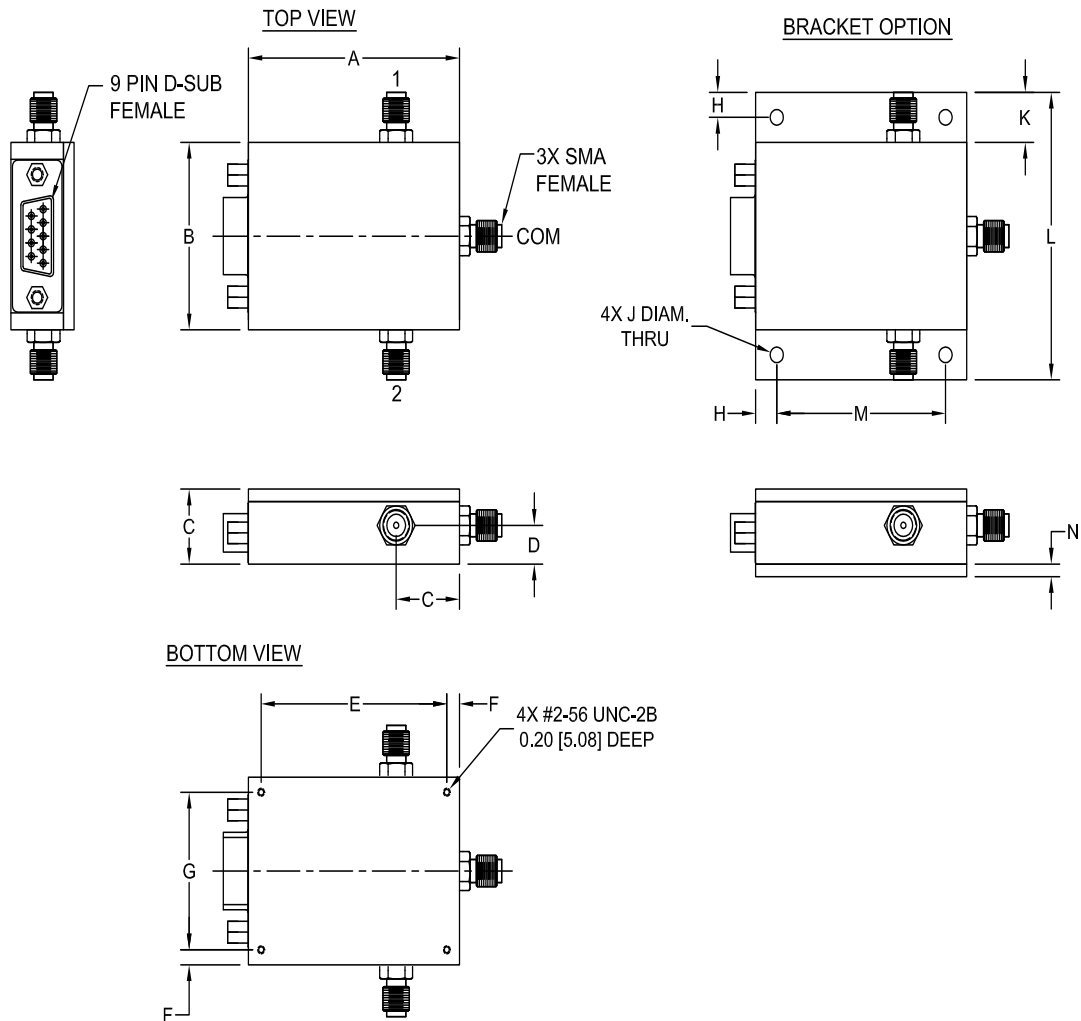

Outline Dimensions (inch / mm)

A	B	C	D	E	F	G	H	J	K	L	M	N	WT. GRAMS
2.00	1.50	.60	.31	1.760	.120	1.260	.200	.125	.40	2.30	1.600	.100	70
50.8	38.1	15.24	7.87	44.7	3.05	32.0	5.08	3.18	10.16	58.4	40.64	2.54	

Typical Performance Curves (Continued)

Insertion Loss RF1 Active (over Temp.)

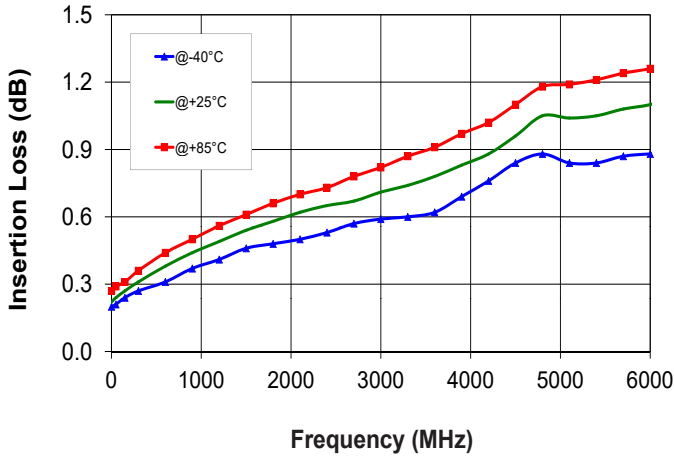

Insertion Loss RF1/2 Active

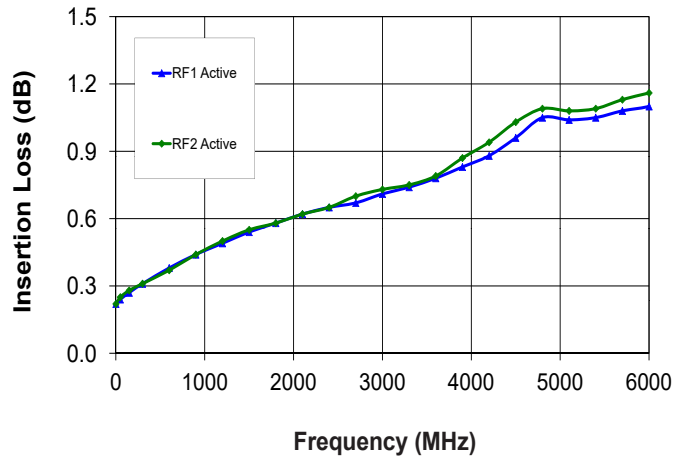

Isolation RF COM to RF1

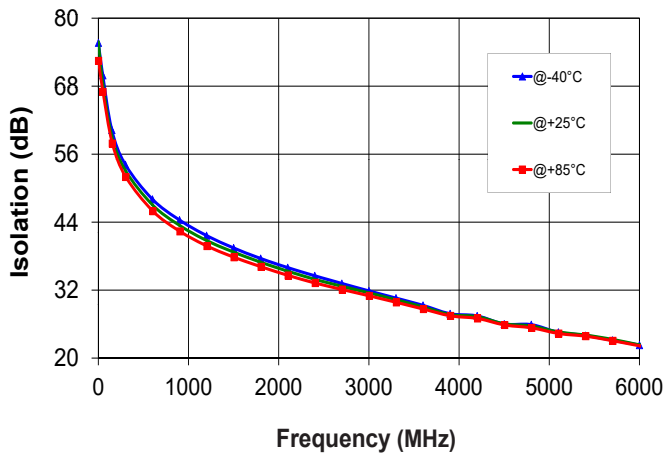

Isolation RF COM to RF2

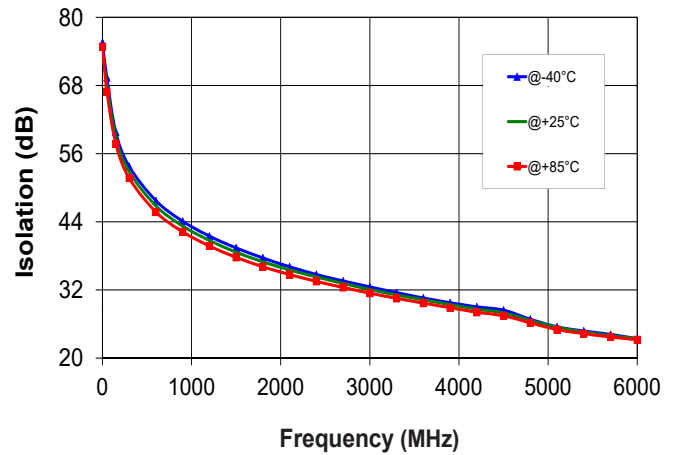

Isolation RF1 to RF2 (RF2 Active)

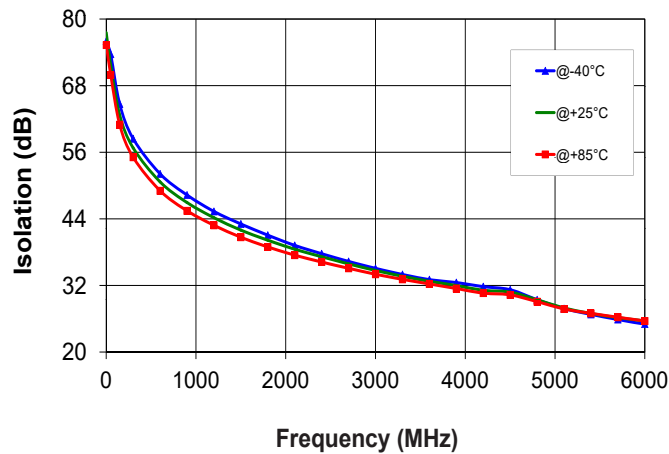

Typical Performance Curves

VSWR RF COM over Temperature

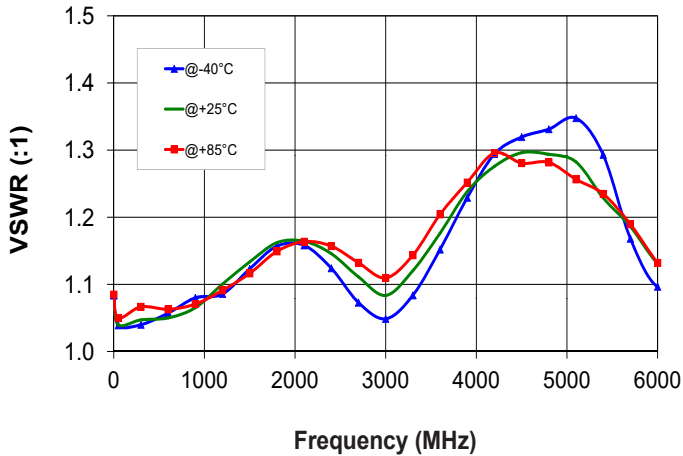

VSWR @ RF COM (RF1/2)

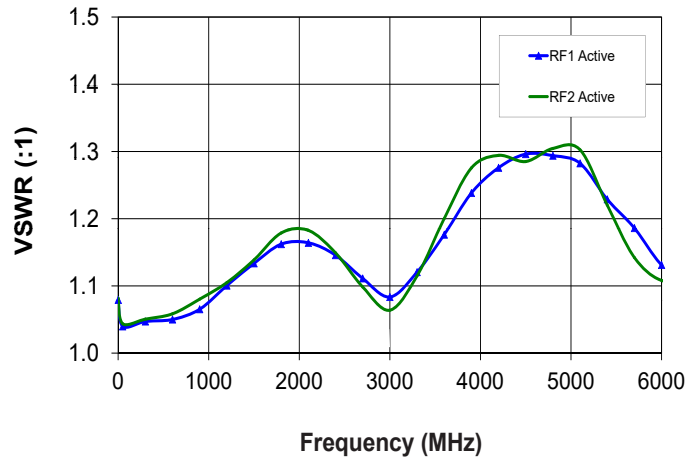

VSWR @ RF1 Active Port over Temp

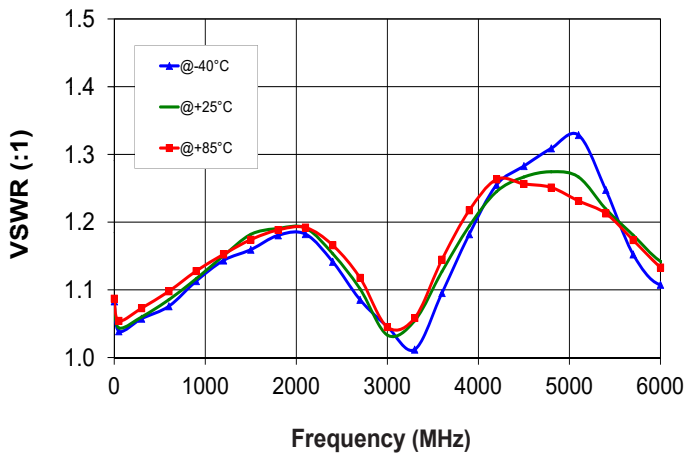

VSWR @ Active Ports RF1/2

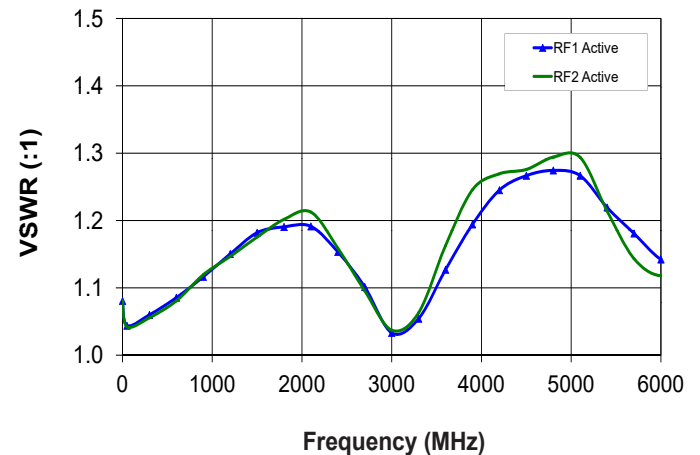

Additional Notes

- Performance and quality attributes and conditions not expressly stated in this specification document are intended to be excluded and do not form a part of this specification document.
- Electrical specifications and performance data contained in this specification document are based on Mini-Circuit's applicable established test performance criteria and measurement instructions.
- The parts covered by this specification document are subject to Mini-Circuits standard limited warranty and terms and conditions (collectively, "Standard Terms"); Purchasers of this part are entitled to the rights and benefits contained therein. For a full statement of the Standard Terms and the exclusive rights and remedies thereunder, please visit Mini-Circuits' website at www.minicircuits.com/MCLStore/terms.jsp

RF SPDT Switch

ZSW2-63DR+

Typical Performance Data

TEST CONDITIONS: @Temperature = -40degC Power In = 0dBm

FREQUENCY (MHz)	INSERTION LOSS (dB)		ISOLATION (dB)			VSWR (:1)		
	COM-J1	COM-J2	COM-J1	COM-J2	J1-J2	COM	J1	J2
1	0.20	0.19	78.57	77.82	75.46	1.08	1.08	1.08
10	0.20	0.19	76.95	76.82	78.22	1.04	1.04	1.04
20	0.20	0.20	75.66	75.61	78.40	1.04	1.04	1.04
30	0.21	0.20	73.76	73.33	76.54	1.04	1.04	1.04
40	0.21	0.21	71.32	71.59	75.34	1.04	1.04	1.04
50	0.21	0.21	69.57	69.63	73.60	1.04	1.04	1.04
60	0.22	0.22	67.86	67.94	72.31	1.04	1.04	1.04
70	0.23	0.22	66.69	66.57	70.79	1.04	1.04	1.04
80	0.23	0.23	65.46	65.40	69.74	1.04	1.04	1.04
90	0.23	0.23	64.56	64.43	68.84	1.04	1.04	1.04
100	0.24	0.24	63.60	63.50	67.80	1.04	1.04	1.04
200	0.26	0.26	57.43	57.32	61.91	1.05	1.05	1.05
300	0.27	0.28	53.86	53.76	58.21	1.04	1.05	1.05
400	0.29	0.30	51.31	51.26	55.57	1.04	1.05	1.05
500	0.30	0.31	49.37	49.32	53.49	1.06	1.05	1.06
600	0.32	0.33	47.73	47.70	51.77	1.08	1.07	1.06
700	0.33	0.35	46.34	46.35	50.31	1.09	1.08	1.07
800	0.35	0.36	45.15	45.16	49.01	1.09	1.09	1.07
900	0.37	0.38	44.07	44.09	47.82	1.10	1.09	1.08
1000	0.38	0.39	43.09	43.12	46.69	1.10	1.10	1.09
1100	0.40	0.41	42.18	42.25	45.66	1.09	1.10	1.09
1200	0.41	0.42	41.32	41.45	44.74	1.10	1.11	1.10
1300	0.43	0.44	40.52	40.70	43.88	1.11	1.12	1.11
1400	0.45	0.46	39.81	40.01	43.11	1.12	1.13	1.13
1500	0.46	0.47	39.11	39.35	42.36	1.13	1.13	1.14
1600	0.47	0.49	38.46	38.73	41.61	1.13	1.14	1.15
1700	0.48	0.50	37.84	38.12	40.88	1.14	1.15	1.16
1800	0.49	0.51	37.26	37.55	40.19	1.14	1.16	1.17
1900	0.50	0.52	36.72	37.00	39.51	1.14	1.16	1.16
2000	0.51	0.53	36.18	36.47	38.85	1.13	1.16	1.16
2200	0.52	0.55	35.19	35.48	37.62	1.11	1.15	1.16
2400	0.54	0.56	34.26	34.59	36.48	1.08	1.13	1.15
2600	0.57	0.58	33.40	33.80	35.36	1.04	1.12	1.15
2800	0.59	0.59	32.55	33.09	34.29	1.05	1.11	1.15
3000	0.60	0.61	31.71	32.41	33.35	1.05	1.10	1.14
3100	0.61	0.62	31.28	32.08	32.91	1.04	1.09	1.13
3300	0.61	0.63	30.42	31.40	32.05	1.06	1.10	1.12
3500	0.62	0.66	29.58	30.74	31.22	1.11	1.13	1.15
3600	0.63	0.67	29.12	30.45	30.77	1.14	1.15	1.16
3700	0.65	0.69	28.63	30.17	30.31	1.16	1.17	1.18
3800	0.68	0.71	28.10	29.89	29.87	1.19	1.19	1.19
4000	0.75	0.75	27.34	29.32	29.62	1.25	1.23	1.24
4200	0.79	0.78	27.27	28.85	29.59	1.27	1.26	1.27
4400	0.84	0.84	26.20	28.43	28.44	1.28	1.27	1.30
4600	0.89	0.92	25.39	27.68	28.26	1.28	1.27	1.32
4800	0.90	0.94	25.57	26.58	28.46	1.27	1.27	1.31
5000	0.87	0.92	24.50	25.57	27.27	1.29	1.28	1.29
5200	0.85	0.88	23.79	24.88	26.38	1.25	1.24	1.24
5400	0.85	0.87	23.49	24.47	25.80	1.19	1.20	1.19
5600	0.86	0.86	22.88	23.99	25.03	1.12	1.15	1.16
5800	0.88	0.87	22.29	23.55	24.33	1.10	1.12	1.15
6000	0.90	0.89	21.75	23.05	23.71	1.11	1.10	1.14
6200	0.90	0.92	21.19	22.61	23.17	1.14	1.12	1.16
6400	0.90	0.96	20.57	22.32	22.48	1.11	1.11	1.16
6600	0.91	0.99	19.96	22.05	21.80	1.06	1.11	1.15
6800	0.96	1.03	19.26	21.85	21.04	1.03	1.10	1.16
7000	1.05	1.10	18.57	21.57	20.21	1.08	1.11	1.16

Notes

- A. Performance and quality attributes and conditions not expressly stated in this specification document are intended to be excluded and do not form a part of this specification document.
- B. Electrical specifications and performance data contained in this specification document are based on Mini-Circuits' applicable established test performance criteria and measurement instructions.
- C. The parts covered by this specification document are subject to Mini-Circuits' standard limited warranty and terms and conditions (collectively, "Standard Terms"). Purchasers of this part are entitled to the rights and benefits contained therein. For a full statement of the Standard Terms and the exclusive rights and remedies thereunder, please visit Mini-Circuits' website at www.minicircuits.com/MCLStore/terms.jsp



RF SPDT Switch

ZSW2-63DR+

Typical Performance Data

TEST CONDITIONS: @Temperature = +25degC Power In = 0dBm

FREQUENCY (MHz)	INSERTION LOSS (dB)		ISOLATION (dB)			VSWR (:1)		
	COM-J1	COM-J2	COM-J1	COM-J2	J1-J2	COM	J1	J2
	1	0.22	0.23	74.93	74.67	75.94	1.08	1.08
10	0.23	0.24	75.48	75.76	76.54	1.04	1.04	1.04
20	0.24	0.24	74.10	73.96	76.31	1.04	1.04	1.04
30	0.24	0.24	71.48	72.00	74.57	1.04	1.04	1.04
40	0.24	0.25	69.93	69.65	72.57	1.04	1.05	1.04
50	0.25	0.25	68.12	67.79	71.39	1.04	1.04	1.04
60	0.25	0.25	66.51	66.41	70.01	1.04	1.04	1.04
70	0.26	0.26	65.24	65.18	68.74	1.04	1.04	1.04
80	0.26	0.26	64.20	64.15	67.60	1.04	1.05	1.04
90	0.26	0.27	63.07	63.15	66.62	1.04	1.05	1.05
100	0.27	0.27	61.89	61.85	65.37	1.04	1.05	1.05
200	0.29	0.29	56.08	56.05	59.76	1.05	1.05	1.05
300	0.32	0.32	52.64	52.56	56.28	1.05	1.06	1.05
400	0.34	0.34	50.18	50.11	53.81	1.06	1.06	1.06
500	0.37	0.36	48.23	48.20	51.77	1.06	1.07	1.07
600	0.39	0.38	46.63	46.61	50.10	1.07	1.08	1.08
700	0.40	0.40	45.28	45.28	48.67	1.07	1.08	1.09
800	0.43	0.42	44.10	44.13	47.41	1.08	1.09	1.10
900	0.45	0.44	43.03	43.10	46.26	1.09	1.10	1.11
1000	0.46	0.47	42.07	42.19	45.21	1.10	1.11	1.12
1100	0.48	0.48	41.16	41.33	44.28	1.10	1.12	1.13
1200	0.50	0.50	40.36	40.55	43.45	1.11	1.13	1.13
1300	0.52	0.52	39.63	39.81	42.68	1.12	1.14	1.14
1400	0.54	0.54	38.95	39.13	41.95	1.12	1.15	1.15
1500	0.55	0.56	38.32	38.49	41.26	1.13	1.16	1.16
1600	0.57	0.57	37.72	37.89	40.58	1.14	1.16	1.17
1700	0.58	0.58	37.14	37.31	39.92	1.14	1.16	1.18
1800	0.59	0.59	36.57	36.77	39.26	1.14	1.16	1.18
1900	0.60	0.60	36.03	36.26	38.61	1.14	1.16	1.18
2000	0.62	0.62	35.50	35.79	37.99	1.13	1.17	1.19
2200	0.65	0.64	34.52	34.91	36.89	1.12	1.16	1.18
2400	0.66	0.66	33.62	34.10	35.91	1.09	1.13	1.15
2600	0.67	0.70	32.82	33.32	34.99	1.06	1.12	1.12
2800	0.70	0.72	32.06	32.59	34.12	1.02	1.10	1.10
3000	0.73	0.75	31.31	31.91	33.20	1.03	1.10	1.11
3100	0.74	0.76	30.91	31.58	32.73	1.05	1.11	1.12
3300	0.77	0.77	30.10	30.96	31.82	1.10	1.14	1.15
3500	0.80	0.80	29.24	30.40	30.97	1.15	1.17	1.20
3600	0.81	0.82	28.78	30.12	30.55	1.17	1.18	1.22
3700	0.82	0.84	28.30	29.84	30.16	1.19	1.20	1.24
3800	0.84	0.88	27.84	29.56	29.82	1.21	1.21	1.25
4000	0.88	0.94	27.28	28.94	29.59	1.24	1.23	1.27
4200	0.91	0.97	27.04	28.42	29.22	1.25	1.24	1.26
4400	0.96	1.02	26.07	27.92	28.21	1.26	1.24	1.25
4600	1.02	1.07	25.62	27.24	28.26	1.25	1.23	1.25
4800	1.07	1.10	25.36	26.38	28.28	1.24	1.23	1.26
5000	1.07	1.10	24.37	25.42	27.35	1.23	1.23	1.28
5200	1.06	1.10	23.83	24.78	26.79	1.23	1.21	1.27
5400	1.06	1.10	23.50	24.27	26.10	1.18	1.18	1.22
5600	1.08	1.13	22.98	23.77	25.24	1.18	1.17	1.19
5800	1.09	1.16	22.39	23.41	24.40	1.15	1.14	1.14
6000	1.11	1.19	21.76	23.07	23.80	1.12	1.13	1.14
6200	1.15	1.20	21.22	22.72	23.27	1.11	1.12	1.14
6400	1.17	1.22	20.73	22.39	22.73	1.08	1.10	1.14
6600	1.21	1.24	20.24	22.07	22.08	1.07	1.09	1.15
6800	1.27	1.32	19.69	21.76	21.24	1.04	1.08	1.13
7000	1.32	1.45	18.95	21.45	20.17	1.02	1.07	1.11

Notes

- A. Performance and quality attributes and conditions not expressly stated in this specification document are intended to be excluded and do not form a part of this specification document.
- B. Electrical specifications and performance data contained in this specification document are based on Mini-Circuits' applicable established test performance criteria and measurement instructions.
- C. The parts covered by this specification document are subject to Mini-Circuits' standard limited warranty and terms and conditions (collectively, "Standard Terms"). Purchasers of this part are entitled to the rights and benefits contained therein. For a full statement of the Standard Terms and the exclusive rights and remedies thereunder, please visit Mini-Circuits' website at www.minicircuits.com/MCLStore/terms.jsp



RF SPDT Switch

ZSW2-63DR+

Typical Performance Data

TEST CONDITIONS: @Temperature = +85degC Power In = 0dBm

FREQUENCY (MHz)	INSERTION LOSS (dB)		ISOLATION (dB)			VSWR (:1)		
	COM-J1	COM-J2	COM-J1	COM-J2	J1-J2	COM	J1	J2
	1	0.26	0.27	75.43	74.42	71.99	1.09	1.09
10	0.27	0.28	73.58	74.00	74.74	1.05	1.05	1.05
20	0.28	0.29	72.80	72.97	74.69	1.05	1.05	1.05
30	0.28	0.29	70.39	70.80	73.07	1.05	1.05	1.05
40	0.28	0.29	68.70	68.65	71.38	1.05	1.06	1.05
50	0.29	0.29	66.97	67.01	69.71	1.05	1.06	1.06
60	0.29	0.30	65.40	65.63	68.51	1.05	1.06	1.06
70	0.29	0.30	64.30	64.31	67.27	1.05	1.06	1.06
80	0.30	0.31	63.18	63.18	66.08	1.05	1.06	1.06
90	0.30	0.31	62.18	62.18	65.02	1.05	1.06	1.06
100	0.30	0.31	61.24	61.30	64.26	1.05	1.06	1.06
200	0.33	0.34	55.27	55.30	58.27	1.06	1.06	1.06
300	0.36	0.37	51.76	51.75	54.92	1.08	1.07	1.08
400	0.39	0.39	49.29	49.28	52.40	1.08	1.08	1.08
500	0.42	0.42	47.33	47.37	50.41	1.08	1.08	1.08
600	0.44	0.44	45.75	45.80	48.79	1.08	1.09	1.09
700	0.46	0.47	44.40	44.47	47.40	1.09	1.10	1.11
800	0.48	0.49	43.22	43.32	46.18	1.09	1.10	1.11
900	0.50	0.51	42.17	42.29	45.06	1.09	1.11	1.12
1000	0.52	0.53	41.22	41.39	44.06	1.10	1.12	1.13
1100	0.54	0.55	40.35	40.55	43.16	1.10	1.12	1.13
1200	0.56	0.57	39.55	39.79	42.36	1.10	1.13	1.13
1300	0.58	0.59	38.84	39.07	41.62	1.10	1.13	1.14
1400	0.59	0.61	38.17	38.39	40.90	1.11	1.14	1.14
1500	0.61	0.62	37.57	37.76	40.24	1.11	1.14	1.15
1600	0.63	0.64	36.99	37.18	39.59	1.12	1.15	1.16
1700	0.64	0.65	36.44	36.61	38.97	1.13	1.16	1.17
1800	0.66	0.67	35.90	36.09	38.36	1.13	1.16	1.18
1900	0.67	0.68	35.38	35.60	37.78	1.13	1.16	1.19
2000	0.69	0.69	34.87	35.14	37.19	1.13	1.17	1.19
2200	0.72	0.71	33.92	34.29	36.18	1.13	1.17	1.19
2400	0.73	0.74	33.08	33.50	35.31	1.11	1.15	1.16
2600	0.76	0.78	32.31	32.77	34.49	1.07	1.13	1.13
2800	0.79	0.81	31.60	32.08	33.67	1.04	1.11	1.11
3000	0.82	0.84	30.87	31.41	32.83	1.04	1.11	1.10
3100	0.83	0.85	30.50	31.09	32.40	1.06	1.11	1.11
3300	0.87	0.88	29.72	30.49	31.56	1.12	1.14	1.16
3500	0.90	0.90	28.91	29.92	30.77	1.18	1.19	1.21
3600	0.91	0.93	28.50	29.65	30.39	1.20	1.20	1.23
3700	0.94	0.96	28.06	29.38	30.01	1.21	1.22	1.25
3800	0.96	0.99	27.62	29.10	29.64	1.22	1.23	1.27
4000	1.00	1.05	27.11	28.49	29.31	1.26	1.26	1.28
4200	1.02	1.09	26.78	27.95	28.83	1.27	1.26	1.27
4400	1.06	1.12	25.87	27.49	27.90	1.25	1.23	1.24
4600	1.12	1.17	25.35	26.86	27.90	1.23	1.22	1.24
4800	1.17	1.21	25.09	26.05	28.02	1.23	1.21	1.25
5000	1.18	1.22	24.12	25.17	27.15	1.22	1.20	1.26
5200	1.18	1.21	23.65	24.47	26.66	1.22	1.20	1.27
5400	1.20	1.23	23.35	24.04	26.09	1.21	1.20	1.25
5600	1.21	1.28	22.82	23.63	25.29	1.19	1.18	1.21
5800	1.23	1.31	22.25	23.28	24.57	1.16	1.16	1.17
6000	1.24	1.35	21.66	22.97	23.94	1.12	1.13	1.15
6200	1.25	1.34	21.12	22.68	23.38	1.09	1.11	1.14
6400	1.31	1.35	20.74	22.28	22.83	1.07	1.09	1.14
6600	1.37	1.39	20.34	21.93	22.15	1.06	1.08	1.13
6800	1.42	1.47	19.86	21.66	21.34	1.04	1.07	1.11
7000	1.50	1.66	19.14	21.57	20.51	1.02	1.06	1.08

Notes

- A. Performance and quality attributes and conditions not expressly stated in this specification document are intended to be excluded and do not form a part of this specification document.
- B. Electrical specifications and performance data contained in this specification document are based on Mini-Circuits' applicable established test performance criteria and measurement instructions.
- C. The parts covered by this specification document are subject to Mini-Circuits' standard limited warranty and terms and conditions (collectively, "Standard Terms"). Purchasers of this part are entitled to the rights and benefits contained therein. For a full statement of the Standard Terms and the exclusive rights and remedies thereunder, please visit Mini-Circuits' website at www.minicircuits.com/MCStore/terms.jsp



RF SPDT Switch

ZSW2-63DR+

Typical Performance Curves

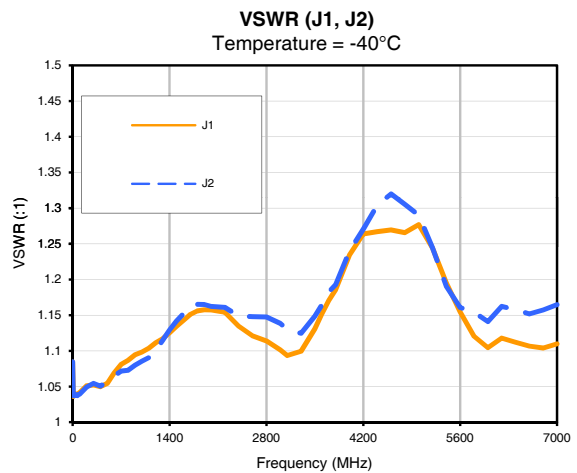
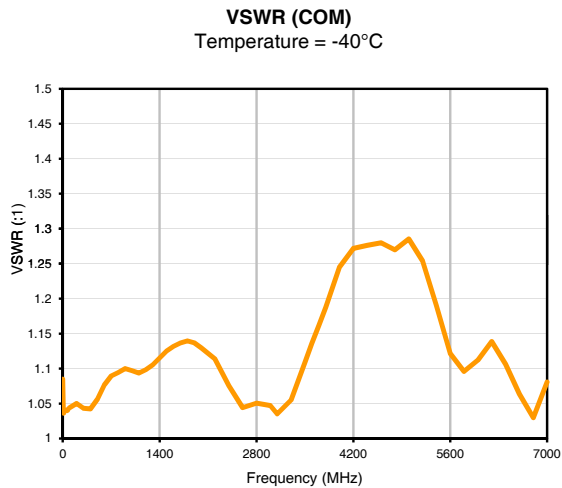
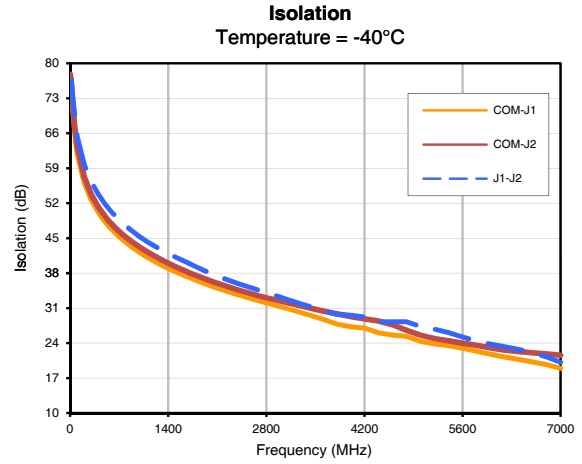
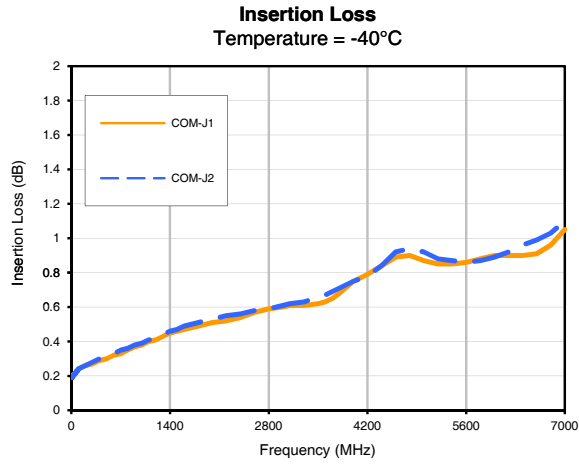

Notes

- A. Performance and quality attributes and conditions not expressly stated in this specification document are intended to be excluded and do not form a part of this specification document.
- B. Electrical specifications and performance data contained in this specification document are based on Mini-Circuits' applicable established test performance criteria and measurement instructions.
- C. The parts covered by this specification document are subject to Mini-Circuits' standard limited warranty and terms and conditions (collectively, "Standard Terms"). Purchasers of this part are entitled to the rights and benefits contained therein. For a full statement of the Standard Terms and the exclusive rights and remedies thereunder, please visit Mini-Circuits' website at www.minicircuits.com/MC/Store/terms.jsp

RF SPDT Switch

ZSW2-63DR+

Typical Performance Curves

Insertion Loss
Temperature = +25°C

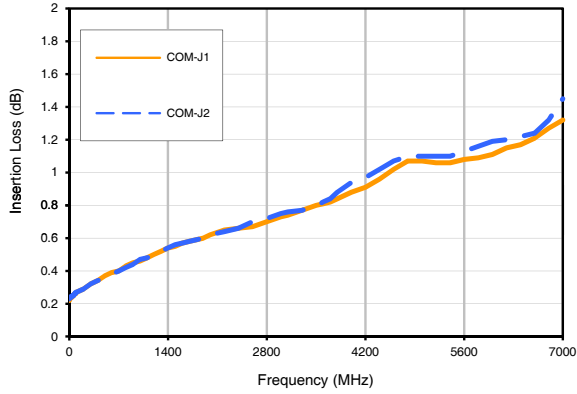

Isolation
Temperature = +25°C

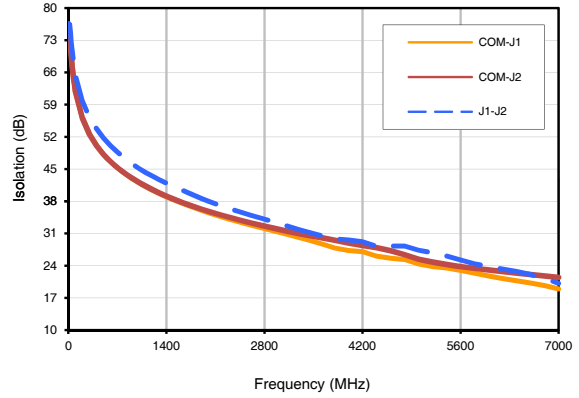

VSWR (COM)
Temperature = +25°C

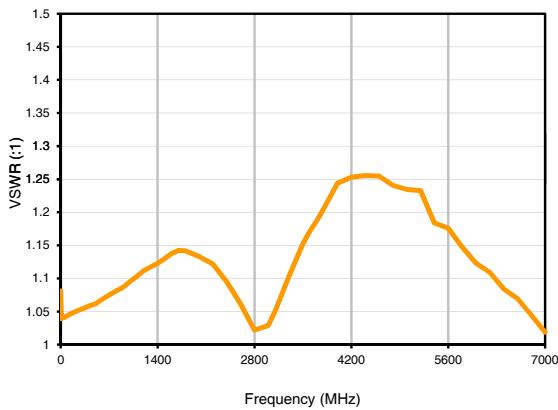

VSWR (J1, J2)
Temperature = +25°C

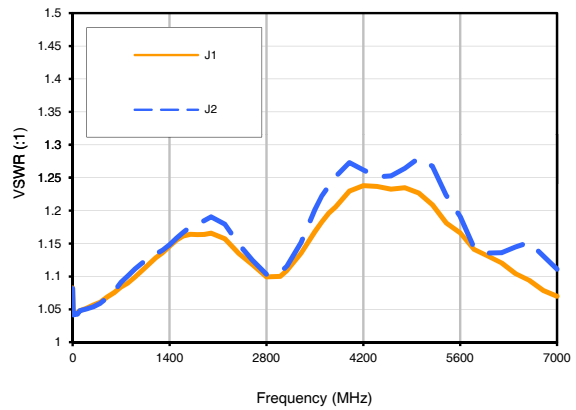

Notes

- A. Performance and quality attributes and conditions not expressly stated in this specification document are intended to be excluded and do not form a part of this specification document.
- B. Electrical specifications and performance data contained in this specification document are based on Mini-Circuits' applicable established test performance criteria and measurement instructions.
- C. The parts covered by this specification document are subject to Mini-Circuits' standard limited warranty and terms and conditions (collectively, "Standard Terms"); Purchasers of this part are entitled to the rights and benefits contained therein. For a full statement of the Standard Terms and the exclusive rights and remedies thereunder, please visit Mini-Circuits' website at www.minicircuits.com/MCLStore/terms.jsp



RF SPDT Switch

ZSW2-63DR+

Typical Performance Curves

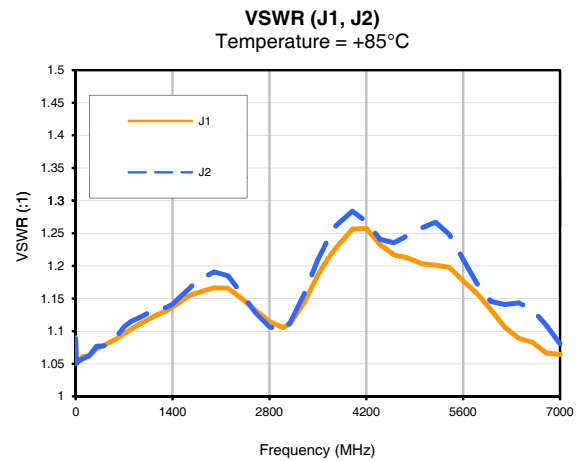
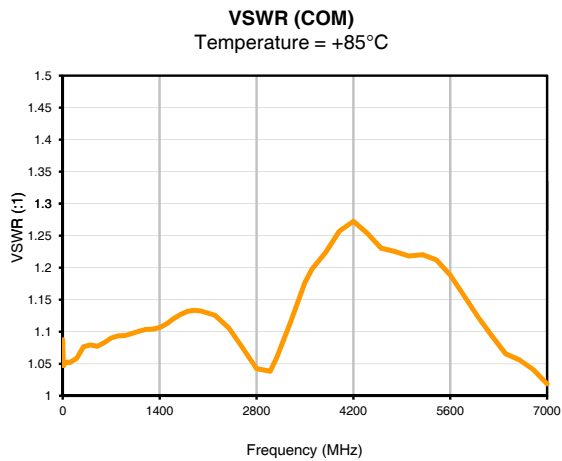
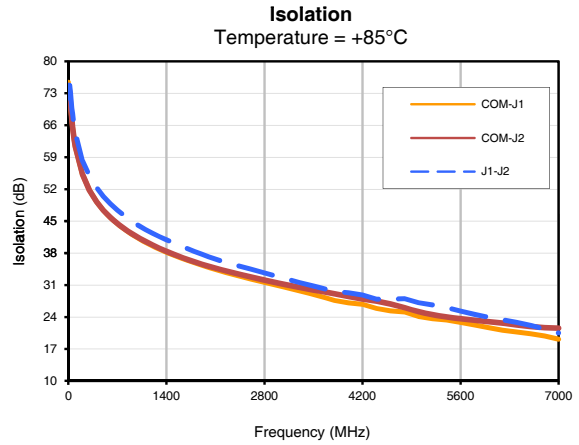
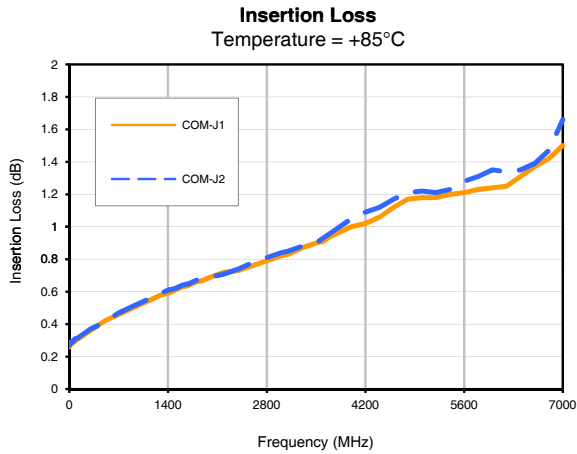

Notes

- A. Performance and quality attributes and conditions not expressly stated in this specification document are intended to be excluded and do not form a part of this specification document.
- B. Electrical specifications and performance data contained in this specification document are based on Mini-Circuits' applicable established test performance criteria and measurement instructions.
- C. The parts covered by this specification document are subject to Mini-Circuits' standard limited warranty and terms and conditions (collectively, "Standard Terms"); Purchasers of this part are entitled to the rights and benefits contained therein. For a full statement of the Standard Terms and the exclusive rights and remedies thereunder, please visit Mini-Circuits' website at www.minicircuits.com/VCLStore/terms.jsp

Case Style

QV

Outline Dimensions

QV2426

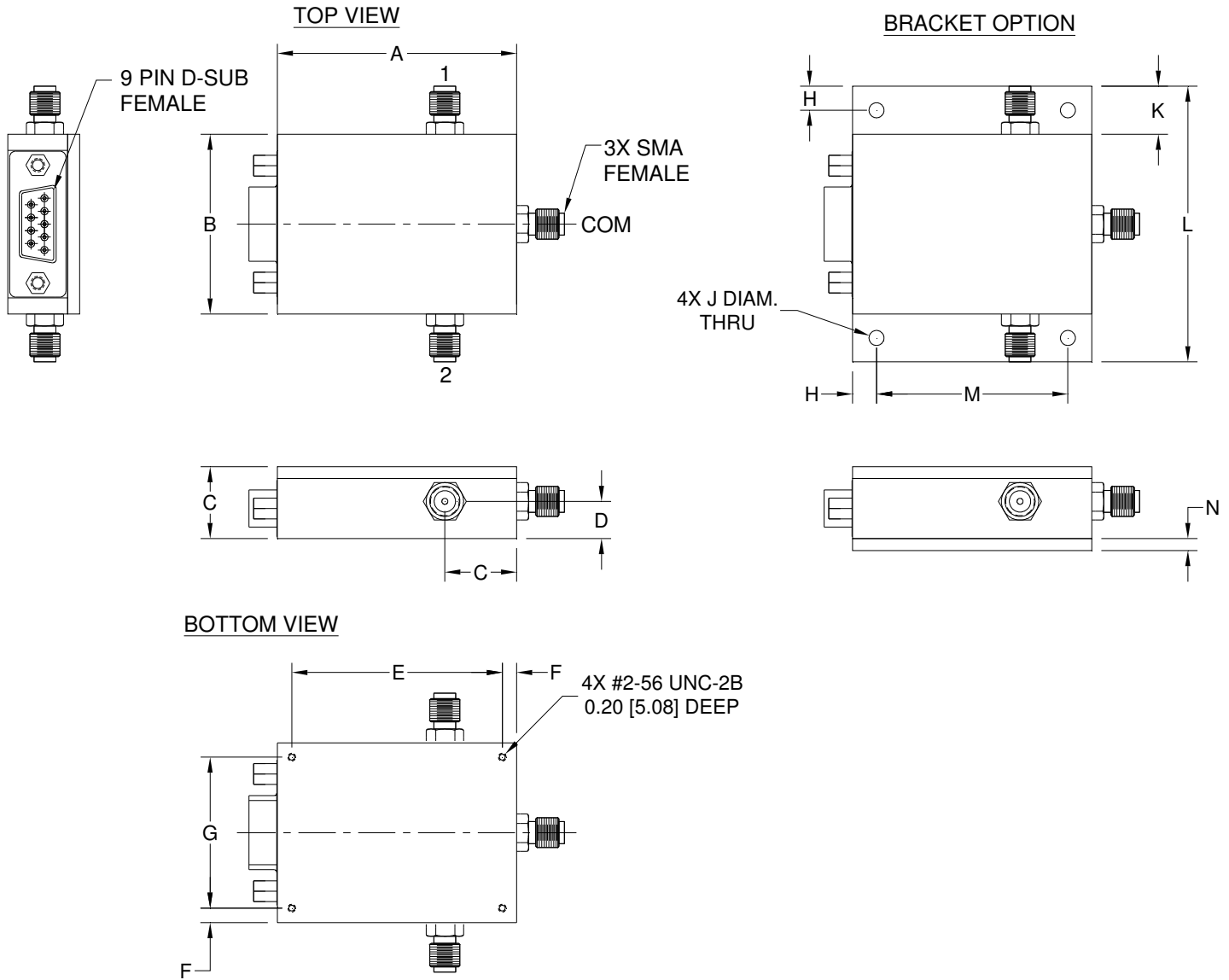

CASE#	A	B	C	D	E	F	G	H	J	K	L	M	N	WT. GRAMS
QV2426	2.00 (50.8)	1.50 (38.1)	.60 (15.24)	.31 (7.87)	1.760 (44.7)	.120 (3.05)	1.260 (32.0)	.200 (5.08)	.125 (3.18)	.40 (10.16)	2.30 (58.4)	1.600 (40.64)	.100 (2.54)	65

Dimensions are in inches (mm). Tolerances: 2PL. +/- .03; 3PL. +/- .015

Notes:

1. Case material: Aluminum alloy.
2. Case finish for RoHS Case Styles: Clear chemical conversion coating, non-chrome or trivalent chrome based.

Mini-Circuits[®]

INTERNET <http://www.minicircuits.com>

P.O. Box 350166, Brooklyn, New York 11235-0003 (718) 934-4500 Fax (718) 332-4661

Distribution Centers NORTH AMERICA 800-654-7949 • 417-335-5935 • Fax 417-335-5945 • EUROPE 44-1252-832600 • Fax 44-1252-837010

Mini-Circuits ISO 9001 & ISO 14001 Certified



All Mini-Circuits products are manufactured under exacting quality assurance and control standards, and are capable of meeting published specifications after being subjected to any or all of the following physical and environmental test.

Specification	Test/Inspection Condition	Reference/Spec
Operating Temperature	-40° to 85°C	Individual Model Data Sheet
Storage Temperature	-55° to 100° C Ambient Environment	Individual Model Data Sheet
Barometric Pressure	100,000 Feet	MIL-STD-202, Method 105, Condition D
Humidity	90% RH, 65°C Units may require bake-out after humidity to restore full performance.	MIL-STD-202, Method 103
Thermal Shock	-65° to 125°C, 5 cycles	MIL-STD-202, Method 107, Condition B
Vibration (High Frequency)	20g peak, 10-2000 Hz, 12 times in each of three perpendicular directions (total 36)	MIL-STD-202, Method 204, Condition D
Mechanical Shock	100g, 6ms sawtooth, 3 shocks each direction 3 axes (total 18)	MIL-STD-202, Method 213, Condition I