

# Coaxial Voltage Controlled Oscillator

## ZOS-75+ ZOS-75

### Dual Output 37.5 to 75 MHz

#### Features

- octave bandwidth
- linear tuning, 3.5 MHz/V typ.
- excellent harmonic suppression, -26 dBc typ.
- rugged shielded case
- protected by US Patent, 6,943,629

#### Applications

- auxiliary output freq. monitoring
- load insensitive source



CASE STYLE: BR386

Connectors	Model	Price	Qty.
SMA	ZOS-75(+)	\$119.95	(1-9)

**+RoHS Compliant**

The +Suffix identifies RoHS Compliance. See our web site for RoHS Compliance methodologies and qualifications

#### Electrical Specifications

FREQUENCY (MHz)		POWER OUTPUT (dBm) Typ.		TUNING VOLTAGE (V)		PHASE NOISE (dBc/Hz) SSB at offset frequencies: Typ.			PULLING (MHz) pk-pk (open/short)	PUSHING (MHz/V) Typ.	TUNING SENSITIVITY (MHz/V) Typ.	HARMONICS (dBc) Typ. Max.		3 dB MODULATION BANDWIDTH (MHz) Typ.	DC OPERATING POWER	
Min.	Max.	Main	Aux.	Min.	Max.	10 kHz	100 kHz	1 MHz	Typ.	Typ.	Typ.	Typ.	Max.	Typ.	V <sub>cc</sub> (volts)	Current (mA) Max.
37.5	75	+9	-12	1	16	-110	-128	-142	0.016	0.15	3.5	-26	-20	0.1	12	140

#### Maximum Ratings

Operating Temperature	-55°C to 85°C
Storage Temperature	-55°C to 100°C
Absolute Max. Supply Voltage (V <sub>cc</sub> )	+16V
Absolute Max. Tuning Voltage (V <sub>tune</sub> )	+18V

all specifications: 50 ohm system  
Permanent damage may occur if any of these limits are exceeded.

#### Outline Drawing

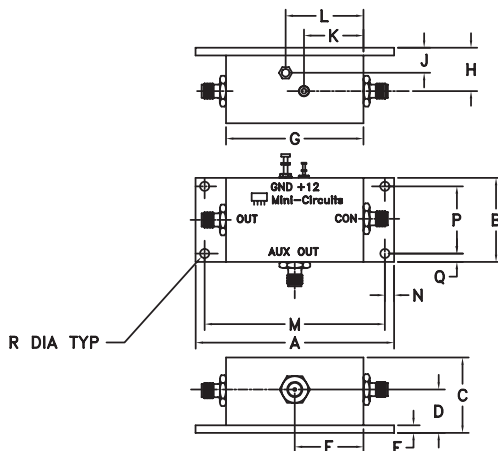

#### Outline Dimensions (inch/mm)

A	B	C	D	E	F	G	H	J	K	L	M	N	P	Q	R	wt
3.25	1.38	1.25	.71	1.13	.125	2.25	.71	.41	.98	1.28	2.950	.15	1.100	.14	.150	grams
82.55	35.05	31.75	18.03	28.70	3.18	57.15	18.03	10.41	24.89	32.51	74.93	3.81	27.94	3.56	3.81	180

#### electrical schematic

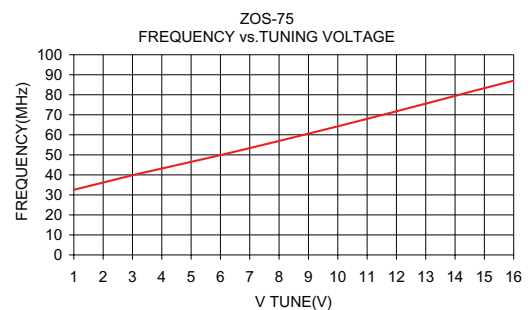
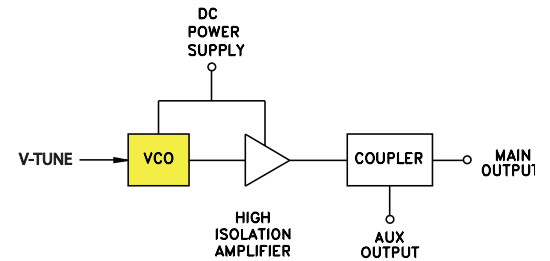

#### Notes

- Performance and quality attributes and conditions not expressly stated in this specification document are intended to be excluded and do not form a part of this specification document.
- Electrical specifications and performance data contained in this specification document are based on Mini-Circuit's applicable established test performance criteria and measurement instructions.
- The parts covered by this specification document are subject to Mini-Circuit's standard limited warranty and terms and conditions (collectively, "Standard Terms"); Purchasers of this part are entitled to the rights and benefits contained therein. For a full statement of the Standard Terms and the exclusive rights and remedies thereunder, please visit Mini-Circuit's website at [www.minicircuits.com/MCLStore/terms.jsp](http://www.minicircuits.com/MCLStore/terms.jsp)



[www.minicircuits.com](http://www.minicircuits.com) P.O. Box 35166, Brooklyn, NY 11235-0003 (718) 934-4500 sales@minicircuits.com

REV. A  
M110171  
ZOS-75  
SK/TD/CP/AM  
120627

# Voltage Controlled Oscillator

# ZOS-75+

## Typical Performance Data

V TUNE	TUNE SENS (MHz/V)	FREQUENCY (MHz)			POWER OUTPUT (dBm)			HARMONICS (dBc)			FREQ. PUSH (MHz/V)	FREQ OFFSET (KHz)	PHASE NOISE (dBc/Hz)
		-55°C	+25°C	+85°C	-55°C	+25°C	+85°C	F2	F3	F4			
1.0	4.40	34.9	34.7	34.3	10.46	10.18	9.28	-24.5	-26.2	-46.0	0.11	10	-110
2.0	3.40	38.3	38.1	37.8	11.15	10.85	9.98	-25.0	-26.1	-39.6	0.14	100	-128
3.0	3.00	41.2	41.1	40.8	11.19	10.90	10.00	-24.7	-26.3	-38.5	0.06	1000	-142
4.0	2.70	44.0	43.8	43.5	11.22	10.91	9.99	-24.3	-26.3	-37.8	0.04		
5.0	2.70	46.7	46.5	46.2	10.96	10.64	9.70	-24.0	-26.5	-37.7	0.02		
6.0	2.80	49.5	49.2	48.9	10.94	10.60	9.66	-24.0	-26.5	-37.3	0.02		
7.0	2.90	52.4	52.2	51.9	10.91	10.53	9.59	-23.9	-26.4	-36.9	0.02		
8.0	3.10	55.5	55.3	54.9	10.68	10.26	9.49	-23.8	-26.3	-36.8	0.04		
9.0	3.30	58.8	58.5	58.2	10.59	10.13	9.19	-23.8	-26.2	-36.8	0.05		
10.0	3.40	62.2	62.0	61.7	10.48	9.97	9.03	-24.0	-26.3	-36.8	0.07		
11.0	3.60	65.8	65.5	65.2	10.19	9.64	8.69	-24.2	-26.3	-37.0	0.08		
12.0	3.60	69.4	69.1	68.8	10.02	9.44	8.50	-24.3	-26.3	-37.1	0.08		
13.0	3.70	73.2	72.8	72.5	9.82	9.22	8.28	-24.4	-26.2	-37.4	0.08		
14.0	3.80	77.1	76.7	76.3	9.45	8.85	7.91	-24.4	-26.0	-37.9	0.09		
15.0	3.90	81.0	80.6	80.2	9.22	8.62	7.69	-24.3	-25.8	-38.5	0.14		
16.0	4.00	85.0	84.5	84.1	8.99	8.39	7.47	-24.4	-25.6	-39.1	0.21		

# Voltage Controlled Oscillator

ZOS-75+

## Typical Performance Data

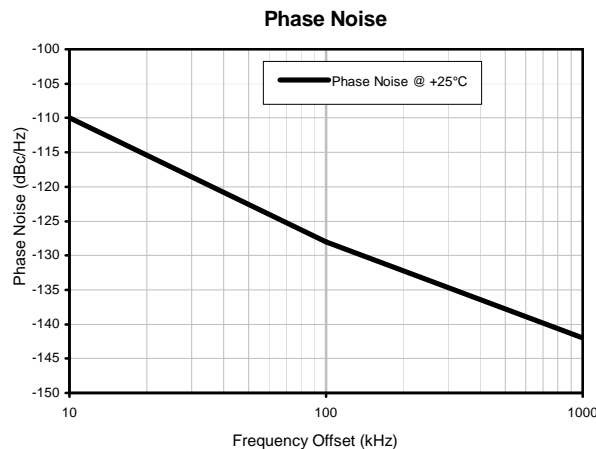
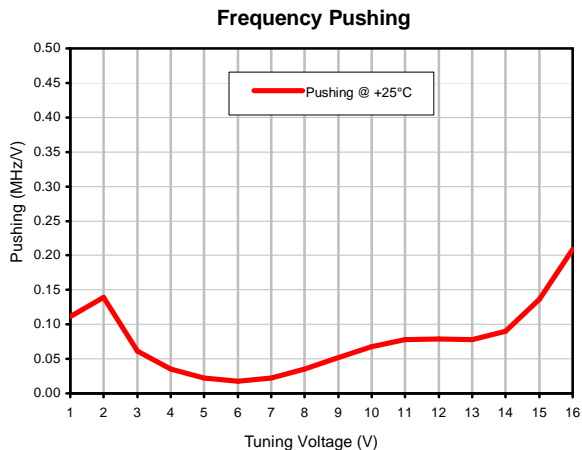
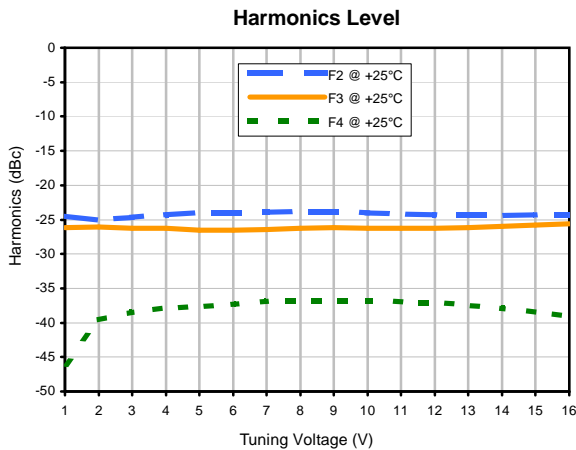
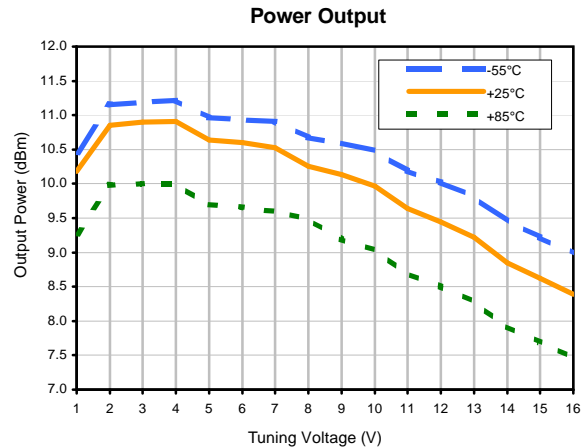
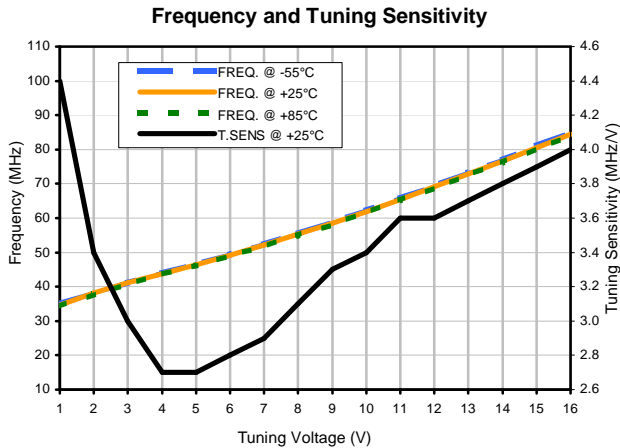

### Outline Dimensions

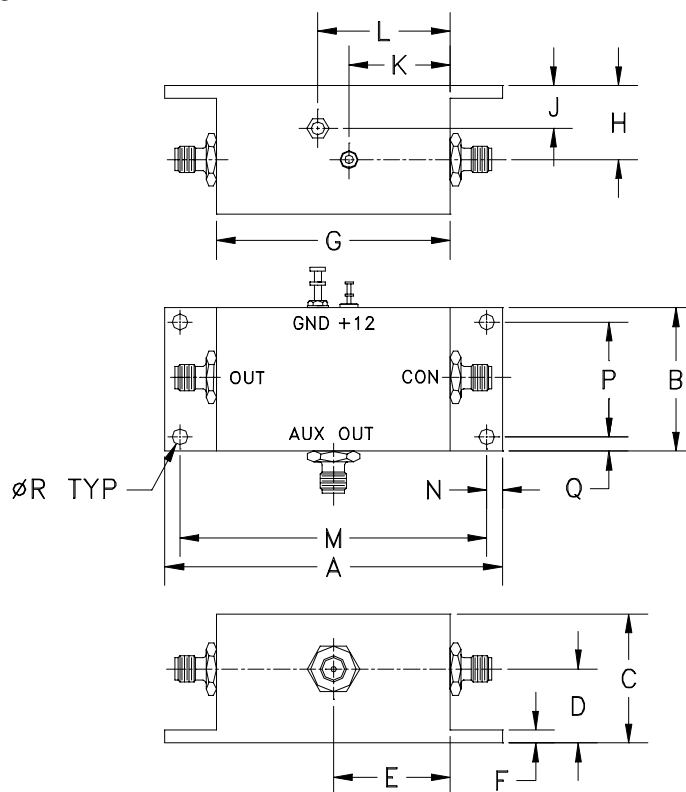

CASE #	A	B	C	D	E	F	G	H	J	K	L
BR386	3.25 (82.55)	1.38 (35.05)	1.25 (31.75)	.71 (18.03)	1.13 (28.70)	.125 (3.18)	2.25 (57.15)	.71 (18.03)	.41 (10.41)	.98 (24.89)	1.28 (32.51)

CASE #	M	N	P	Q	R	WT. GRAM
BR386	2.950 (74.93)	.15 (3.81)	1.100 (27.94)	.14 (3.56)	.150 (3.81)	180

Dimensions are in inches (mm). Tolerances: 2Pl.  $\pm .03$ ; 3 Pl.  $\pm .015$

#### Notes:

- Case material: Aluminum alloy.
- Case finish:  
For RoHS Case Styles: Clear chemical conversion coating, non-chrome or trivalent chrome based.



INTERNET <http://www.minicircuits.com>  
 P.O. Box 350166, Brooklyn, New York 11235-0003 (718) 934-4500 Fax (718) 332-4661  
 Distribution Centers NORTH AMERICA 800-654-7949 • 417-335-5935 • Fax 417-335-5945 • EUROPE 44-1252-832600 • Fax 44-1252-837010  
 Mini-Circuits ISO 9001 & ISO 14001 Certified



All Mini-Circuits products are manufactured under exacting quality assurance and control standards, and are capable of meeting published specifications after being subjected to any or all of the following physical and environmental test.

Specification	Test/Inspection Condition	Reference/Spec
Operating Temperature	-55° to 85°C Ambient Environment	Individual Model Data Sheet
Storage Temperature	-55° to 100° C Ambient Environment	Individual Model Data Sheet
Barometric Pressure	100,000 Feet	MIL-STD-202, Method 105, Condition D
Humidity	90% RH, 65°C Units may require bake-out after humidity to restore full performance.	MIL-STD-202, Method 103
Thermal Shock	-65° to 125°C, 5 cycles	MIL-STD-202, Method 107, Condition B
Vibration (High Frequency)	20g peak, 10-2000 Hz, 12 times in each of three perpendicular directions (total 36)	MIL-STD-202, Method 204, Condition D
Mechanical Shock	100g, 6ms sawtooth, 3 shocks each direction 3 axes (total 18)	MIL-STD-202, Method 213, Condition I