

Coaxial Voltage Controlled Oscillator

ZOS-1025+

Dual Output 685 to 1025 MHz

Features

- wide bandwidth
- linear tuning
- excellent harmonic suppression, -25 dBc typ.
- rugged shielded case
- protected by US Patent, 6,943,629

Applications

- auxiliary output freq. monitoring
- load insensitive source



Connectors	Model
SMA	ZOS-1025+

+RoHS Compliant
The +Suffix identifies RoHS Compliance. See our web site for RoHS Compliance methodologies and qualifications

Electrical Specifications

FREQUENCY (MHz)		POWER OUTPUT (dBm) Typ.		TUNING VOLTAGE (V)		PHASE NOISE (dBc/Hz) SSB at offset frequencies: Typ.			PULLING (MHz) pk-pk (open/short)	PUSHING (MHz/V)	TUNING SENSITIVITY (MHz/V)	HARMONICS (dBc)		3 dB MODULATION BANDWIDTH (MHz)	DC OPERATING POWER	
Min.	Max.	Main	Aux.	Min.	Max.	10 kHz	100 kHz	1 MHz	Typ.	Typ.	Typ.	Typ.	Max.	Typ.	V _{cc} (volts)	Current (mA) Max.
685	1025	+8	-13	1	16	-92	-112	-136	0.051	1.00	30	-25	-18	0.1	12	140

Maximum Ratings

Operating Temperature	-55°C to 85°C
Storage Temperature	-55°C to 100°C
Absolute Max. Supply Voltage (V _{cc})	+16V
Absolute Max. Tuning Voltage (V _{tune})	+18V

all specifications: 50 ohm system
Permanent damage may occur if any of these limits are exceeded.

Outline Drawing

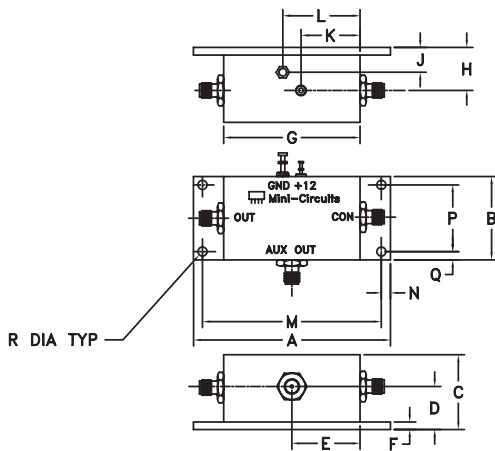

Outline Dimensions (inch/mm)

A	B	C	D	E	F	G	H	J	K	L	M	N	P	Q	R	wt
3.25	1.38	1.25	.71	1.13	.125	2.25	.71	.41	.98	1.28	2.950	.15	1.100	.14	.150	grams
82.55	35.05	31.75	18.03	28.70	3.18	57.15	18.03	10.41	24.89	32.51	74.93	3.81	27.94	3.56	3.81	180

electrical schematic

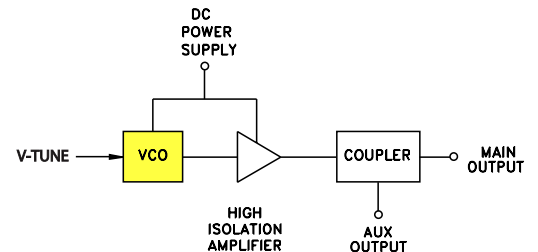

ZOS-1025
FREQUENCY vs. TUNING VOLTAGE

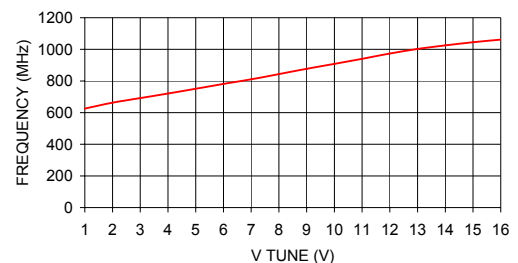

Notes

- Performance and quality attributes and conditions not expressly stated in this specification document are intended to be excluded and do not form a part of this specification document.
- Electrical specifications and performance data contained in this specification document are based on Mini-Circuit's applicable established test performance criteria and measurement instructions.
- The parts covered by this specification document are subject to Mini-Circuits standard limited warranty and terms and conditions (collectively, "Standard Terms"); Purchasers of this part are entitled to the rights and benefits contained therein. For a full statement of the Standard Terms and the exclusive rights and remedies thereunder, please visit Mini-Circuits' website at www.minicircuits.com/MCLStore/terms.jsp



Voltage Controlled Oscillator

ZOS-1025+

Typical Performance Data

V TUNE	TUNE SENS (MHz/V)	FREQUENCY (MHz)			POWER OUTPUT (dBm)			HARMONICS (dBc)			FREQ. PUSH (MHz/V)	FREQ OFFSET (KHz)	PHASE NOISE (dBc/Hz)
		-55°C	+25°C	+85°C	-55°C	+25°C	+85°C	F2	F3	F4			
1.0	50.30	657.2	641.7	637.3	9.07	8.43	8.07	-31.4	-39.1	-31.1	0.51	10	-92
2.0	41.20	692.5	682.9	679.5	9.32	9.05	8.83	-43.8	-43.1	-28.4	-0.07	100	-112
3.0	30.80	722.7	713.7	710.0	9.21	9.54	9.42	-41.2	-39.0	-33.2	0.08	1000	-136
4.0	31.60	754.2	745.3	740.8	9.34	9.49	9.24	-33.5	-38.9	-45.5	0.60		
5.0	25.10	781.1	770.3	764.6	9.38	9.23	9.34	-31.0	-41.2	-50.4	-0.38		
6.0	22.40	804.8	792.7	786.0	9.41	9.46	9.24	-30.2	-41.9	-50.2	-0.42		
7.0	21.40	828.1	814.0	806.3	9.69	9.62	9.48	-29.7	-40.2	-55.7	-0.27		
8.0	19.70	850.0	833.8	826.0	9.87	9.76	9.43	-29.7	-35.0	-50.3	0.38		
9.0	23.60	867.5	857.4	851.2	10.12	9.94	9.43	-30.2	-31.4	-45.7	0.07		
10.0	29.40	897.2	886.8	879.8	9.95	10.05	9.53	-30.7	-30.8	-51.8	1.33		
11.0	27.30	925.4	914.1	906.6	9.45	9.55	8.91	-30.3	-30.8	-54.8	0.92		
12.0	24.30	950.7	938.3	930.4	9.37	9.22	8.61	-29.8	-30.3	-48.8	-0.05		
13.0	26.80	980.5	965.2	956.3	9.20	9.01	8.39	-30.2	-29.4	-49.4	-0.90		
14.0	31.20	1013.3	996.4	986.8	8.86	8.81	8.27	-30.7	-28.8	-45.3	-1.08		
15.0	29.90	1043.7	1026.3	1016.5	9.39	9.08	8.54	-31.0	-28.2	-43.0	-1.22		
16.0	27.90	1071.7	1054.1	1044.0	9.01	8.79	8.39	-32.6	-26.8	-38.1	-1.32		

Voltage Controlled Oscillator

ZOS-1025+

Typical Performance Data

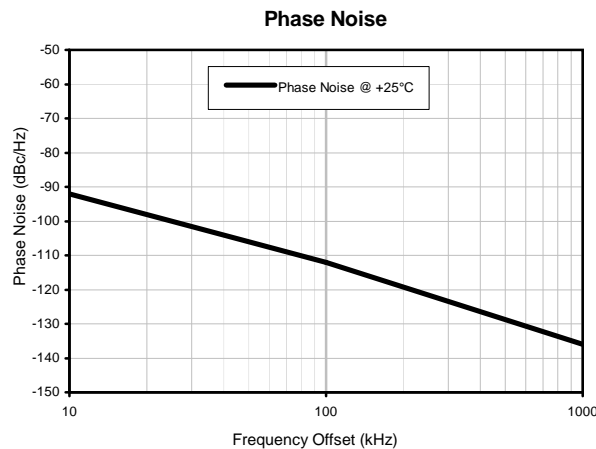
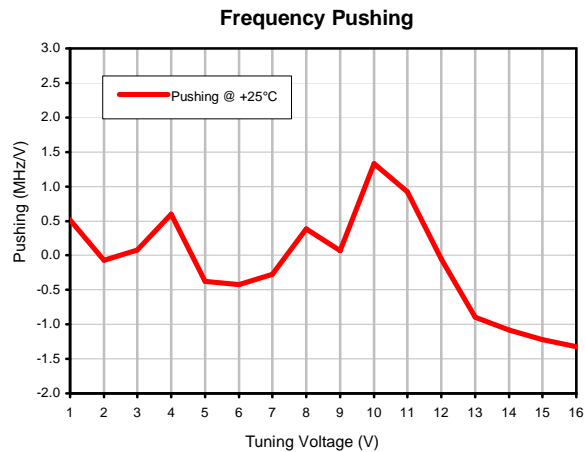
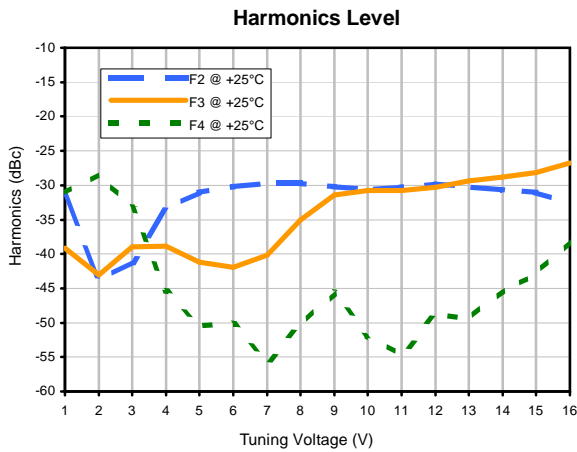
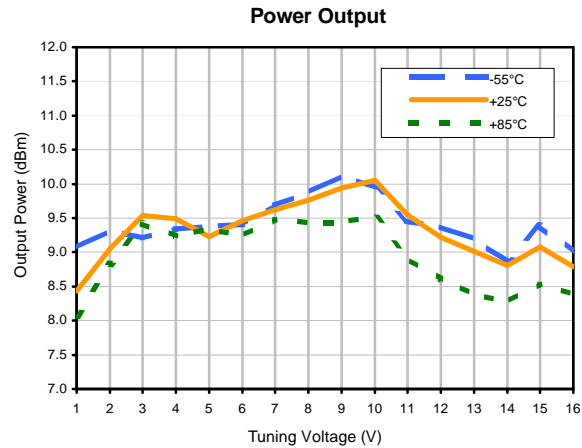
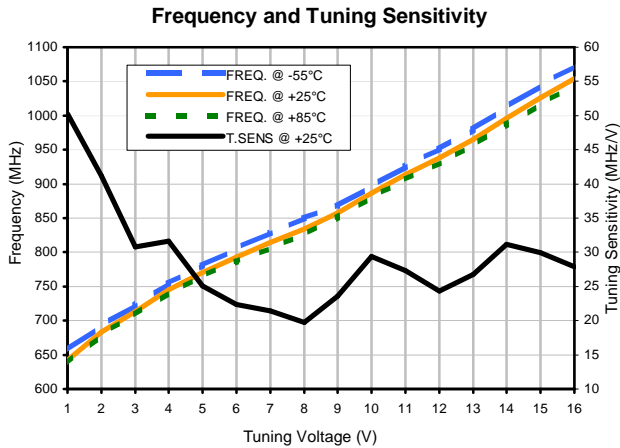

Outline Dimensions

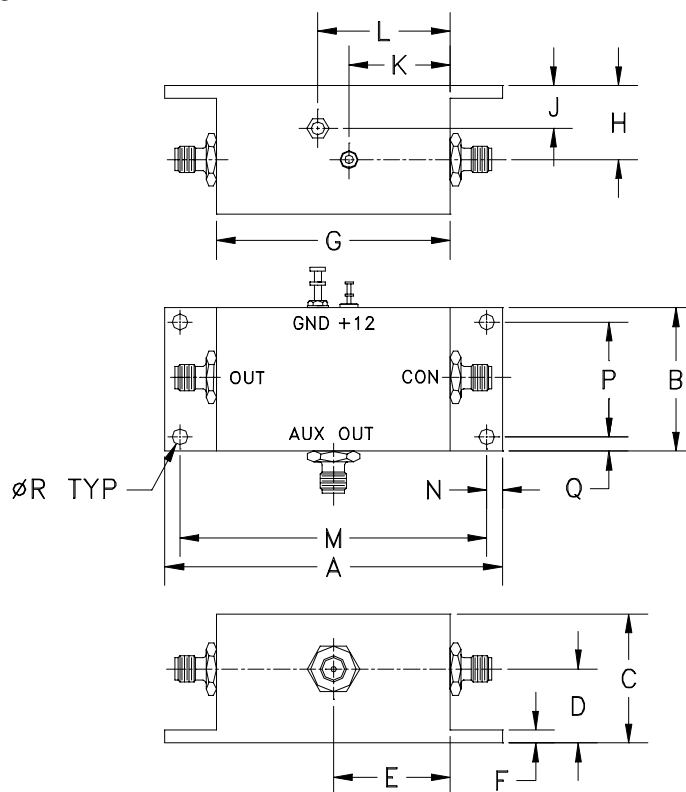

CASE #	A	B	C	D	E	F	G	H	J	K	L
BR386	3.25 (82.55)	1.38 (35.05)	1.25 (31.75)	.71 (18.03)	1.13 (28.70)	.125 (3.18)	2.25 (57.15)	.71 (18.03)	.41 (10.41)	.98 (24.89)	1.28 (32.51)

CASE #	M	N	P	Q	R	WT. GRAM
BR386	2.950 (74.93)	.15 (3.81)	1.100 (27.94)	.14 (3.56)	.150 (3.81)	180

Dimensions are in inches (mm). Tolerances: 2Pl. ± .03; 3 Pl. ± .015

Notes:

- Case material: Aluminum alloy.
- Case finish:
For RoHS Case Styles: Clear chemical conversion coating, non-chrome or trivalent chrome based.



All Mini-Circuits products are manufactured under exacting quality assurance and control standards, and are capable of meeting published specifications after being subjected to any or all of the following physical and environmental test.

Specification	Test/Inspection Condition	Reference/Spec
Operating Temperature	-55° to 85°C Ambient Environment	Individual Model Data Sheet
Storage Temperature	-55° to 100° C Ambient Environment	Individual Model Data Sheet
Barometric Pressure	100,000 Feet	MIL-STD-202, Method 105, Condition D
Humidity	90% RH, 65°C Units may require bake-out after humidity to restore full performance.	MIL-STD-202, Method 103
Thermal Shock	-65° to 125°C, 5 cycles	MIL-STD-202, Method 107, Condition B
Vibration (High Frequency)	20g peak, 10-2000 Hz, 12 times in each of three perpendicular directions (total 36)	MIL-STD-202, Method 204, Condition D
Mechanical Shock	100g, 6ms sawtooth, 3 shocks each direction 3 axes (total 18)	MIL-STD-202, Method 213, Condition I