



COAXIAL, WIDEBAND

Frequency Mixer

ZMDB-653H-E+

Mini-Circuits

Level 15 (LO Power +15 dBm) 20 to 65 GHz 1.85mm Female

THE BIG DEAL

- Super Wideband RF & LO, 20 to 65 GHz
- Excellent input IP3, +20 dBm typ.
- Excellent IF bandwidth, DC to 20 GHz
- High L-R isolation, 45 dB typ.
- Usable as Up & Down Converter



Generic photo used for illustration purposes only

APPLICATIONS

- Satellite up and down converters VSAT
- Defense radar & communication
- 5G
- ISM
- WiGig

Model No.	ZMDB-653H-E+
Case Style	UK2938
Connectors	1.85mm Female

+RoHS Compliant
 The +Suffix identifies RoHS Compliance.
 See our website for methodologies and qualifications

PRODUCT OVERVIEW

Mini-Circuits' ZMDB-653H-E+ coaxial frequency mixer provides an RF and LO frequency range from 20 to 65 GHz and an IF frequency range from DC to 20 GHz. The mixer is ideal for use in wideband millimeter wave systems for communications, defense and test and measurement applications. This model handles input power up to +21 dBm and provides high L-R isolation. The mixer comes housed in a rugged, 1.85mm connectorized housing suitable for assembled systems and lab use.

KEY FEATURES

Feature	Advantages
Wide bandwidth, 20 to 65 GHz	Useful in wideband systems and several narrowband systems, reducing inventory.
Wide IF bandwidth, DC to 20 GHz	Usable in first and second down converter applications. IF down to DC enables use in phase detector applications.
High isolation, <ul style="list-style-type: none"> • L-R, 45 dB typ. • L-I, 30 dB typ. 	Preserves signal integrity from input to output and reduces undesired signal responses that can interfere with system performance.
High IP3, +20 dBm	Minimizes third order intermodulation distortion and enables high-dynamic range.
1.85mm-F connectorized housing	Ideal for assembled systems and lab use. High-frequency connector mates with 1.85mm and SMA





COAXIAL, WIDEBAND

Frequency Mixer

ZMDB-653H-E+

Mini-Circuits

Level 15 (LO Power +15 dBm) 20 to 65 GHz 1.85mm Female

ELECTRICAL SPECIFICATIONS AT 25°C

Parameter	Frequency (GHz)	Min.	Typ.	Max.	Units
Frequency Range, RF		20		65	GHz
Frequency Range, LO		20	—	65	GHz
Frequency Range, IF		DC	—	20	GHz
Conversion Loss*	20 - 65	—	11	16	dB
LO to RF Isolation	20 - 65	—	45	—	dB
LO to IF Isolation	20 - 65	—	30	—	dB
IP3	20 - 65	—	20	—	dBm
RF Input at 1 dB Compression	20 - 65	—	+10	—	dBm

* Conversion loss at 30 MHz IF. Increases with IF frequency.

MAXIMUM RATINGS

Parameter	Ratings
Operating Temperature	-40°C to 85°C
Storage Temperature	-55°C to 100°C
RF Power	125mW

Permanent damage may occur if any of these limits are exceeded.

ELECTRICAL SCHEMATIC

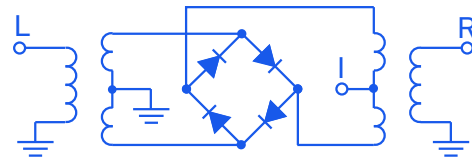



COAXIAL, WIDEBAND

Frequency Mixer

ZMDB-653H-E+

Mini-Circuits

Level 15 (LO Power +15 dBm) 20 to 65 GHz 1.85mm Female

COAXIAL CONNECTIONS

LO	2
RF	1
IF	3

OUTLINE DRAWING

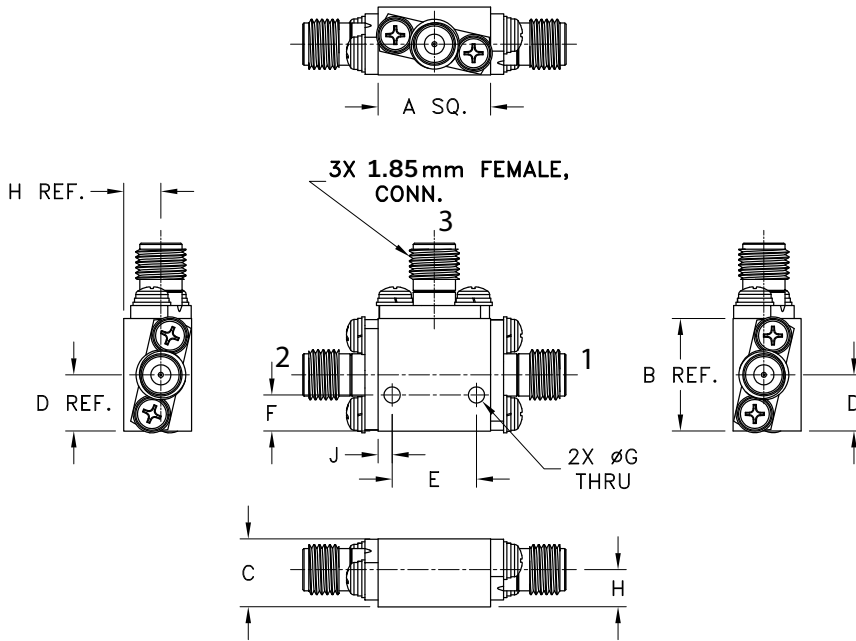

OUTLINE DIMENSIONS (Inches/mm)

A	B	C	D	E	F	G	H	J	weight
.56	.56	.34	.28	.420	.18	.081	.19	.07	grams
14.22	14.22	8.64	7.11	10.67	4.57	2.06	4.83	1.78	23





COAXIAL, WIDEBAND

Frequency Mixer

ZMDB-653H-E+

Mini-Circuits

Level 15 (LO Power +15 dBm) 20 to 65 GHz 1.85mm Female

TYPICAL PERFORMANCE DATA/CURVES

Frequency (MHz)		Conversion Loss (dB)	Isolation L-R (dB)	Isolation L-I (dB)	VSWR RF Port (:1)	VSWR LO Port (:1)
RF	LO					
20000.10	20030.10	9.50	34.63	33.32	3.250	3.91
22000.10	22030.10	10.73	39.52	40.67	4.478	3.01
24000.10	24030.10	11.09	43.09	43.79	4.883	2.06
26000.10	26030.10	11.07	45.93	41.17	4.297	1.55
28000.10	28030.10	10.97	44.88	40.18	3.326	1.41
30000.10	30030.10	10.21	45.72	43.16	3.247	1.42
34000.10	34030.10	9.32	40.74	42.88	2.397	2.15
38000.10	38030.10	9.07	35.58	37.96	2.053	2.98
40000.10	40030.10	9.37	36.79	35.05	2.399	2.94
44000.10	44030.10	10.27	36.30	29.55	2.679	2.26
48000.10	48030.10	11.02	38.57	22.01	3.958	1.94
50000.10	50030.10	11.22	50.15	25.42	3.926	2.26
54000.10	54030.10	9.06	48.91	26.48	1.110	1.94
58000.10	58030.10	10.72	41.51	26.91	2.389	—
60000.10	60030.10	10.10	42.59	30.41	1.758	—
62000.10	62030.10	10.42	41.55	31.19	2.410	—
65000.10	65030.10	13.14	40.41	27.15	4.021	—

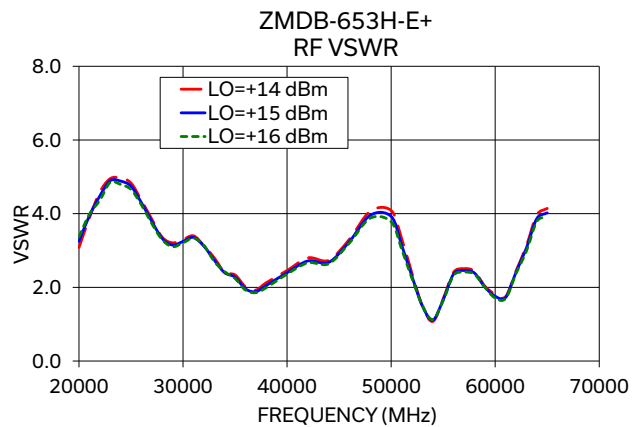
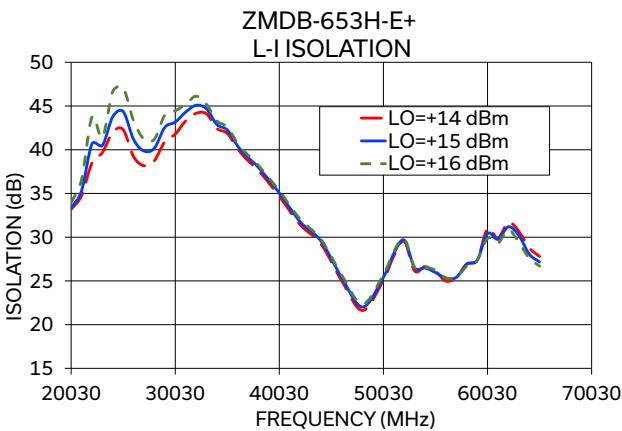
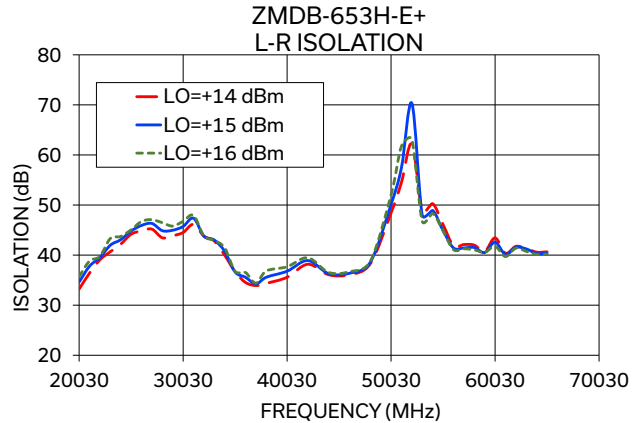
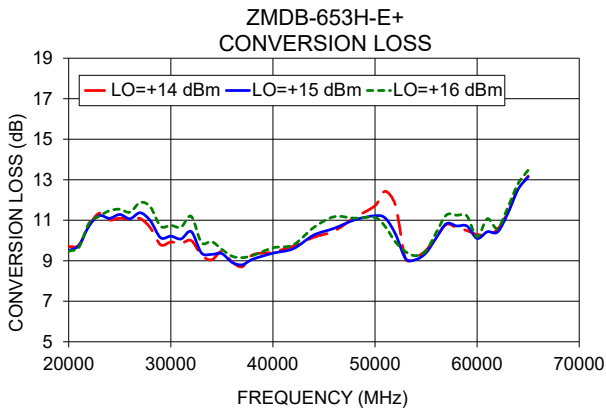



COAXIAL, WIDEBAND

Frequency Mixer

ZMDB-653H-E+



Level 15 (LO Power +15 dBm) 20 to 65 GHz 1.85mm Female

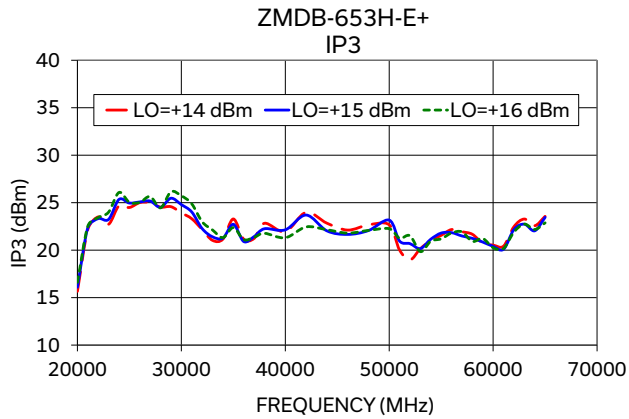
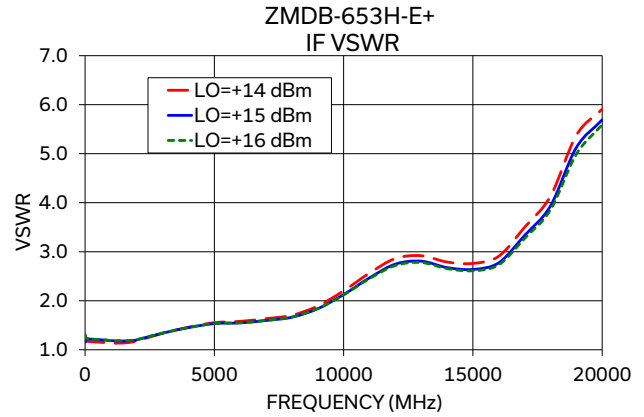
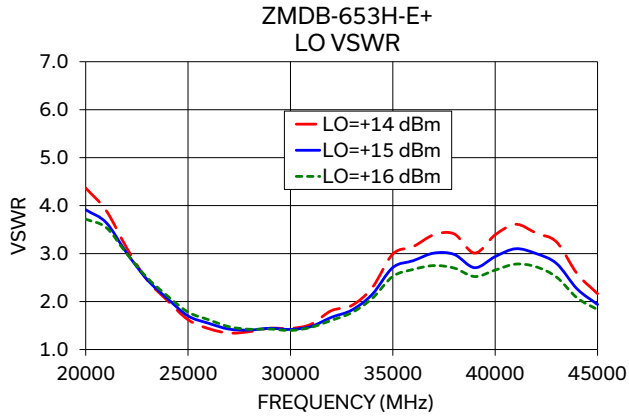

NOTES

- A. Performance and quality attributes and conditions not expressly stated in this specification document are intended to be excluded and do not form a part of this specification document.
- B. Electrical specifications and performance data contained in this specification document are based on Mini-Circuit's applicable established test performance criteria and measurement instructions.
- C. The parts covered by this specification document are subject to Mini-Circuits standard limited warranty and terms and conditions (collectively, "Standard Terms"); Purchasers of this part are entitled to the rights and benefits contained therein. For a full statement of the standard. Terms and the exclusive rights and remedies thereunder, please visit Mini-Circuits' website at www.minicircuits.com/terms/viewterm.html



Frequency Mixer

ZMDB-653H-E+

Typical Performance Data

RF (IN) (MHz)	LO (MHz)	CONVERSION LOSS IF FIXED @IF(OUT)=30MHz (dB)		
		@LO (dBm)		
		+14	+15	+16
20000.1	20030.1	9.70	9.50	9.47
21000.1	21030.1	9.77	9.76	9.67
22000.1	22030.1	10.74	10.73	10.87
23000.1	23030.1	11.35	11.22	11.20
24000.1	24030.1	11.01	11.09	11.47
25000.1	25030.1	11.10	11.29	11.54
26000.1	26030.1	11.04	11.07	11.40
27000.1	27030.1	11.08	11.37	11.88
28000.1	28030.1	10.62	10.97	11.65
29000.1	29030.1	9.79	10.14	10.70
30000.1	30030.1	9.92	10.21	10.75
31000.1	31030.1	9.85	10.08	10.66
32000.1	32030.1	10.00	10.44	11.19
33000.1	33030.1	9.28	9.39	9.90
34000.1	34030.1	9.05	9.32	9.95
35000.1	35030.1	9.46	9.35	9.56
36000.1	36030.1	8.94	8.92	9.22
37000.1	37030.1	8.71	8.80	9.15
38000.1	38030.1	9.29	9.07	9.25
40000.1	40030.1	9.42	9.37	9.64
42000.1	42030.1	9.73	9.60	9.79
44000.1	44030.1	10.16	10.27	10.64
46000.1	46030.1	10.47	10.60	11.17
48000.1	48030.1	11.13	11.02	11.10
50000.1	50030.1	11.72	11.22	11.14
51000.1	51030.1	12.43	11.11	10.68
52000.1	52030.1	11.74	10.32	9.93
53000.1	53030.1	9.08	9.10	9.45
54000.1	54030.1	9.17	9.06	9.25
55000.1	55030.1	9.52	9.39	9.49
56000.1	56030.1	10.19	10.13	10.40
57000.1	57030.1	10.80	10.83	11.26
58000.1	58030.1	10.64	10.72	11.25
59000.1	59030.1	10.49	10.71	11.21
60000.1	60030.1	10.29	10.10	10.18
61000.1	61030.1	10.27	10.43	11.07
62000.1	62030.1	10.55	10.42	10.59
63000.1	63030.1	11.39	11.33	11.63
64000.1	64030.1	12.53	12.52	12.80
65000.1	65030.1	13.18	13.14	13.47

RF (IN) (MHz)	LO (MHz)	IP-3 INPUT (dBm)		
		@LO (dBm)		
		+14	+15	+16
20000.0	20030.0	15.66	16.10	16.61
21000.0	21030.0	22.17	22.36	22.52
22000.0	22030.0	23.50	23.32	23.43
23000.0	23030.0	22.73	23.24	24.00
24000.0	24030.0	24.68	25.34	26.07
25000.0	25030.0	24.49	24.96	25.04
26000.0	26030.0	25.01	25.08	25.03
27000.0	27030.0	25.01	25.17	25.64
28000.0	28030.0	24.53	24.51	24.46
29000.0	29030.0	24.58	25.47	26.15
30000.0	30030.0	23.93	24.80	25.73
31000.0	31030.0	23.31	24.02	24.88
32000.0	32030.0	22.18	22.27	22.99
33000.0	33030.0	21.03	21.40	22.12
34000.0	34030.0	21.16	21.27	21.32
35000.0	35030.0	23.29	22.72	22.38
36000.0	36030.0	21.16	20.91	21.11
37000.0	37030.0	21.23	21.43	21.35
38000.0	38030.0	22.83	22.26	21.77
40000.0	40030.0	21.94	22.14	21.31
42000.0	42030.0	23.98	23.70	22.45
44000.0	44030.0	22.84	22.04	22.15
46000.0	46030.0	22.11	21.66	21.79
48000.0	48030.0	22.66	22.06	22.08
50000.0	50030.0	22.66	23.16	22.26
51000.0	51030.0	20.00	20.95	21.26
52000.0	52030.0	18.98	20.68	21.52
53000.0	53030.0	20.15	20.17	19.85
54000.0	54030.0	21.02	21.15	20.94
55000.0	55030.0	21.56	21.80	21.19
56000.0	56030.0	22.17	21.84	21.81
57000.0	57030.0	21.94	21.49	21.92
58000.0	58030.0	21.67	21.24	20.92
59000.0	59030.0	20.74	20.85	21.22
60000.0	60030.0	20.53	20.40	20.26
61000.0	61030.0	20.42	20.09	20.17
62000.0	62030.0	22.47	22.17	21.90
63000.0	63030.0	23.28	22.74	22.74
64000.0	64030.0	22.57	22.04	22.18
65000.0	65030.0	23.56	23.46	22.87

RF (IN) (MHz)	LO (MHz)	COMPRESSION @RF IN=+10dBm (dB)		
		@LO (dBm)		
		+14	+15	+16
25000.1	25030.1	0.70	0.68	0.69
26000.1	26030.1	0.79	0.77	0.74
27000.1	27030.1	0.08	0.27	0.20
28000.1	28030.1	0.20	0.16	0.04
29000.1	29030.1	0.24	0.19	0.14
30000.1	30030.1	0.31	0.20	0.09
31000.1	31030.1	0.32	0.32	0.16
32000.1	32030.1	0.30	0.32	0.21
33000.1	33030.1	0.42	0.30	0.31
34000.1	34030.1	0.33	0.27	0.14
35000.1	35030.1	0.17	0.20	0.15
36000.1	36030.1	0.23	0.37	0.17
37000.1	37030.1	0.38	0.39	0.15
38000.1	38030.1	0.32	0.36	0.24
40000.1	40030.1	0.31	0.48	0.36
42000.1	42030.1	0.26	0.35	0.28
44000.1	44030.1	0.21	0.38	0.29
46000.1	46030.1	0.33	0.42	0.27
48000.1	48030.1	0.31	0.40	0.32
50000.1	50030.1	0.56	0.43	0.27
51000.1	51030.1	0.19	0.49	0.33
52000.1	52030.1	0.26	0.61	0.36
53000.1	53030.1	0.45	0.60	0.46
54000.1	54030.1	0.36	0.44	0.40
55000.1	55030.1	0.22	0.46	0.31
56000.1	56030.1	0.28	0.33	0.26
57000.1	57030.1	0.30	0.38	0.22
58000.1	58030.1	0.28	0.35	0.22
59000.1	59030.1	0.42	0.43	0.26
60000.1	60030.1	0.57	0.54	0.55
61000.1	61030.1	0.49	0.56	0.34
62000.1	62030.1	0.27	0.35	0.21
63000.1	63030.1	0.20	0.23	0.27
64000.1	64030.1	0.21	0.26	0.28
65000.1	65030.1	0.00	0.00	0.00

Frequency Mixer

ZMDB-653H-E+

Typical Performance Data

IF (OUT) (MHz)	LO (MHz)	CONVERSION LOSS VS. IF FREQUENCY @RF(IN)=20000.1MHz (dB)			IF (OUT) (MHz)	LO (MHz)	CONVERSION LOSS VS. IF FREQUENCY @RF(IN)=42500.1MHz (dB)			IF (OUT) (MHz)	LO (MHz)	CONVERSION LOSS VS. IF FREQUENCY @RF(IN)=65000.1MHz (dB)		
		@LO (dBm)					@LO (dBm)					@LO (dBm)		
		+14	+15	+16			+14	+15	+16			+14	+15	+16
10.0	20010.1	9.92	9.54	9.38	10.0	42510.1	9.88	9.97	9.71	30000.0	35000.1	25.92	25.98	26.25
20.0	20020.1	9.73	9.51	9.44	20.0	42520.1	9.86	9.74	9.96	29000.0	36000.1	24.17	24.26	24.61
30.0	20030.1	9.68	9.49	9.44	30.0	42530.1	9.91	9.77	9.94	28000.0	37000.1	22.78	22.90	23.21
40.0	20040.1	9.68	9.51	9.38	40.0	42540.1	9.95	9.81	9.92	27000.0	38000.1	21.09	21.05	21.39
50.0	20050.1	9.74	9.52	9.45	50.0	42550.1	9.90	9.78	9.97	26000.0	39000.1	19.12	19.25	19.74
60.0	20060.1	9.74	9.59	9.49	60.0	42560.1	9.88	9.80	9.97	25000.0	40000.1	17.88	17.91	18.33
70.0	20070.1	9.75	9.57	9.43	70.0	42570.1	9.93	9.78	9.96	23000.0	42000.1	21.25	20.40	19.92
80.0	20080.1	9.72	9.55	9.41	80.0	42580.1	9.90	9.80	9.95	21000.0	44000.1	19.67	19.28	19.30
90.0	20090.1	9.68	9.50	9.36	90.0	42590.1	9.90	9.79	9.95	19000.0	46000.1	17.48	17.18	17.34
100.0	20100.1	9.68	9.48	9.38	100.0	42600.1	9.89	9.78	9.95	17000.0	48000.1	17.17	16.75	16.60
200.0	20200.1	9.67	9.48	9.34	200.0	42700.1	9.90	9.84	10.05	15000.0	50000.1	17.48	16.55	16.07
300.0	20300.1	9.59	9.41	9.28	300.0	42800.1	9.88	9.87	10.13	13000.0	52000.1	19.97	17.21	16.30
400.0	20400.1	9.41	9.27	9.20	400.0	42900.1	9.89	9.92	10.28	11000.0	54000.1	15.30	15.07	15.33
500.0	20500.1	9.36	9.26	9.21	500.0	43000.1	9.91	9.99	10.42	9000.0	56000.1	14.44	14.41	14.76
600.0	20600.1	9.30	9.25	9.22	600.0	43100.1	9.92	10.08	10.55	7000.0	58000.1	14.47	14.48	15.05
700.0	20700.1	9.27	9.24	9.24	700.0	43200.1	9.94	10.15	10.70	5000.0	60000.1	14.63	14.19	14.09
800.0	20800.1	9.24	9.23	9.25	800.0	43300.1	9.96	10.23	10.80	3000.0	62000.1	14.00	13.79	13.81
900.0	20900.1	9.19	9.19	9.24	900.0	43400.1	9.98	10.27	10.87	1000.0	64000.1	13.33	13.25	13.50
1000.0	21000.1	9.10	9.16	9.23	1000.0	43500.1	9.95	10.28	10.88	900.0	64100.1	13.34	13.22	13.46
1100.0	21100.1	9.16	9.23	9.31	1100.0	43600.1	9.98	10.28	10.85	800.0	64200.1	13.33	13.21	13.43
1200.0	21200.1	9.16	9.25	9.41	1200.0	43700.1	9.95	10.21	10.78	700.0	64300.1	13.32	13.18	13.39
2000.0	22000.1	9.42	9.69	10.02	1500.0	44000.1	9.97	10.07	10.48	600.0	64400.1	13.29	13.17	13.38
3000.0	23000.1	9.45	9.54	9.65	2500.0	45000.1	10.09	10.11	10.43	500.0	64500.1	13.28	13.13	13.32
4000.0	24000.1	9.92	10.18	10.54	3500.0	46000.1	10.09	10.21	10.64	400.0	64600.1	13.25	13.13	13.36
5000.0	25000.1	10.29	10.58	10.96	4500.0	47000.1	10.71	10.37	10.28	300.0	64700.1	13.24	13.12	13.33
6000.0	26000.1	10.51	10.74	11.06	5500.0	48000.1	10.66	10.50	10.48	200.0	64800.1	13.23	13.14	13.37
7000.0	27000.1	11.01	11.35	11.71	6500.0	49000.1	12.55	11.30	10.84	100.0	64900.1	13.19	13.10	13.39
8000.0	28000.1	11.18	11.44	11.78	7500.0	50000.1	11.29	10.71	10.52	90.0	64910.1	13.18	13.14	13.39
9000.0	29000.1	11.29	11.54	11.85	8500.0	51000.1	12.87	11.32	10.69	80.0	64920.1	13.19	13.11	13.39
10000.0	30000.1	11.60	11.79	12.11	9500.0	52000.1	13.95	11.72	10.98	70.0	64930.1	13.21	13.09	13.40
11000.0	31000.1	12.14	12.38	12.74	10500.0	53000.1	11.06	10.99	11.25	60.0	64940.1	13.16	13.13	13.40
12000.0	32000.1	12.81	13.16	13.59	11500.0	54000.1	11.39	11.20	11.43	50.0	64950.1	13.19	13.13	13.41
13000.0	33000.1	12.23	12.42	12.74	12500.0	55000.1	11.57	11.43	11.55	45.0	64955.1	13.21	13.07	13.43
14000.0	34000.1	12.41	12.73	13.18	13500.0	56000.1	11.47	11.51	11.87	40.0	64960.1	13.19	13.16	13.45
15000.0	35000.1	12.51	12.75	13.05	14500.0	57000.1	11.54	11.81	12.48	35.0	64965.1	13.25	13.05	13.37
16000.0	36000.1	13.36	13.53	13.89	15500.0	58000.1	11.78	11.93	12.71	30.0	64970.1	13.15	13.15	13.36
17000.0	37000.1	13.92	14.14	14.47	16500.0	59000.1	12.48	12.92	13.51	25.0	64975.1	13.11	13.09	13.33
18000.0	38000.1	14.39	14.48	14.66	17500.0	60000.1	13.31	12.94	12.88	20.0	64980.1	13.21	13.05	13.45
19000.0	39000.1	14.31	14.46	14.77	18500.0	61000.1	13.01	13.10	13.84	15.0	64985.1	13.09	12.97	13.46
20000.0	40000.1	14.81	14.96	15.19	19500.0	62000.1	14.08	13.84	13.83	10.0	64990.1	13.36	12.72	13.93

Frequency Mixer

ZMDB-653H-E+

Typical Performance Data

LO (MHz)	LO-RF ISOLATION (dB)			LO-IF ISOLATION (dB)			RF (IN) (MHz)	LO (MHz)	RF-IF ISOLATION (dB)		
	@LO (dBm)			@LO (dBm)					@LO (dBm)		
	+14	+15	+16	+14	+15	+16			+14	+15	+16
20030.1	33.21	34.63	35.74	33.18	33.32	33.96	20000.1	20030.1	30.47	31.36	32.53
21030.1	36.41	37.79	38.81	34.75	35.30	36.56	21000.1	21030.1	37.49	38.00	37.56
22030.1	39.06	39.52	39.76	38.48	40.67	43.72	22000.1	22030.1	41.38	41.41	41.09
23030.1	40.68	41.98	43.32	39.68	40.48	41.42	23000.1	23030.1	40.76	41.25	41.84
24030.1	42.18	43.09	43.72	41.99	43.79	46.67	24000.1	24030.1	40.95	39.77	37.92
25030.1	44.17	44.82	45.05	42.28	44.36	47.08	25000.1	25030.1	43.14	42.39	40.34
26030.1	44.84	45.93	46.72	39.21	41.17	43.31	26000.1	26030.1	41.22	41.43	41.63
27030.1	45.18	46.32	47.08	38.18	39.85	41.20	27000.1	27030.1	38.35	38.83	39.74
28030.1	43.46	44.88	46.47	38.76	40.18	41.20	28000.1	28030.1	36.50	37.18	38.19
29030.1	43.85	44.97	45.80	40.92	42.56	43.96	29000.1	29030.1	34.04	34.25	34.68
30030.1	44.52	45.72	46.76	41.78	43.16	44.44	30000.1	30030.1	32.50	32.53	32.89
31030.1	46.15	47.37	47.93	43.28	44.30	45.20	31000.1	31030.1	31.44	31.34	31.58
32030.1	43.81	43.78	43.81	44.16	45.08	46.12	32000.1	32030.1	30.56	30.43	30.55
33030.1	42.81	43.01	42.94	44.11	44.68	45.20	33000.1	33030.1	29.31	29.29	29.29
34030.1	39.98	40.74	41.44	42.43	42.88	43.30	34000.1	34030.1	28.55	28.47	28.55
35030.1	36.67	36.63	36.77	41.87	42.26	42.59	35000.1	35030.1	26.65	26.69	26.73
36030.1	34.55	35.57	36.52	40.09	40.41	40.70	36000.1	36030.1	25.09	25.24	25.29
37030.1	33.92	34.25	34.41	38.73	39.11	39.38	37000.1	37030.1	24.25	24.37	24.45
38030.1	34.36	35.58	36.83	37.64	37.96	38.19	38000.1	38030.1	22.91	23.04	23.16
40030.1	35.58	36.79	37.68	34.66	35.05	35.29	40000.1	40030.1	21.99	22.03	22.11
42030.1	38.18	38.91	39.47	31.42	31.76	32.05	42000.1	42030.1	20.64	20.60	20.68
44030.1	36.09	36.30	36.54	29.22	29.55	29.76	44000.1	44030.1	20.62	20.68	20.60
46030.1	36.09	36.38	36.68	24.99	25.35	25.64	46000.1	46030.1	18.78	18.72	18.74
48030.1	38.28	38.57	38.75	21.62	22.01	22.34	48000.1	48030.1	16.93	16.94	16.94
50030.1	48.46	50.15	52.04	25.10	25.42	25.74	50000.1	50030.1	20.83	20.87	20.90
51030.1	54.55	57.50	61.76	27.86	28.13	28.36	51000.1	51030.1	23.23	23.30	23.35
52030.1	62.18	70.32	63.08	29.50	29.66	29.82	52000.1	52030.1	24.36	24.43	24.50
53030.1	48.84	47.89	46.73	26.14	26.49	26.54	53000.1	53030.1	24.71	24.60	24.54
54030.1	50.27	48.91	48.32	26.63	26.48	26.58	54000.1	54030.1	25.36	25.19	25.02
55030.1	46.12	44.89	44.85	26.12	25.95	26.22	55000.1	55030.1	26.07	25.84	25.64
56030.1	41.84	41.43	41.09	24.98	25.32	25.35	56000.1	56030.1	27.07	26.91	26.78
57030.1	42.11	41.44	41.27	25.39	25.40	25.39	57000.1	57030.1	27.93	27.73	27.76
58030.1	42.00	41.51	41.06	26.93	26.91	26.68	58000.1	58030.1	27.88	27.52	27.71
59030.1	40.72	40.52	40.55	27.34	27.36	27.32	59000.1	59030.1	27.25	27.17	27.26
60030.1	43.45	42.59	41.74	30.97	30.41	29.87	60000.1	60030.1	27.40	27.31	27.31
61030.1	40.38	40.14	39.72	29.87	29.75	29.32	61000.1	61030.1	27.62	27.55	27.62
62030.1	41.75	41.55	41.39	31.70	31.19	30.84	62000.1	62030.1	27.78	27.82	27.81
63030.1	41.30	41.24	40.75	30.67	30.22	29.44	63000.1	63030.1	28.15	28.11	28.17
64030.1	40.59	40.31	40.15	28.78	28.07	27.59	64000.1	64030.1	28.66	28.59	28.73
65030.1	40.66	40.41	40.21	27.8	27.2	26.7	65000.1	65030.1	30.6	30.6	30.8

Frequency Mixer

ZMDB-653H-E+

Typical Performance Data

RF (IN) (MHz)	LO (MHz)	RF VSWR (:1)			LO (MHz)	LO VSWR (:1)			IF (OUT) (MHz)	IF VSWR @LO=65030.1MHz (:1)		
		@LO (dBm)				@LO (dBm)				@LO (dBm)		
		+14	+15	+16		+14	+15	+16		+14	+15	+16
20000.1	20030.1	3.08	3.25	3.37	20000.0	4.37	3.91	3.72	10	1.20	1.16	1.31
21000.1	21030.1	3.88	3.94	3.98	21000.0	3.90	3.65	3.54	50	1.17	1.23	1.23
22000.1	22030.1	4.58	4.48	4.36	22000.0	3.12	3.01	3.00	100	1.17	1.22	1.23
23000.1	23030.1	4.95	4.89	4.85	23000.0	2.45	2.46	2.50	200	1.17	1.22	1.22
24000.1	24030.1	4.97	4.88	4.79	24000.0	2.02	2.06	2.11	300	1.16	1.22	1.22
25000.1	25030.1	4.83	4.75	4.66	25000.0	1.62	1.70	1.78	400	1.16	1.21	1.21
26000.1	26030.1	4.36	4.30	4.24	26000.0	1.44	1.55	1.62	500	1.16	1.21	1.21
27000.1	27030.1	3.85	3.79	3.73	27000.0	1.34	1.43	1.48	600	1.15	1.20	1.21
28000.1	28030.1	3.36	3.33	3.29	28000.0	1.37	1.41	1.42	700	1.15	1.20	1.20
29000.1	29030.1	3.21	3.15	3.10	29000.0	1.44	1.44	1.43	800	1.15	1.20	1.20
30000.1	30030.1	3.30	3.25	3.21	30000.0	1.44	1.42	1.40	900	1.14	1.19	1.19
31000.1	31030.1	3.40	3.36	3.33	31000.0	1.53	1.48	1.46	1000	1.14	1.19	1.19
32000.1	32030.1	3.14	3.12	3.14	32000.0	1.81	1.67	1.61	1100	1.14	1.18	1.19
33000.1	33030.1	2.80	2.74	2.71	33000.0	1.92	1.82	1.77	1200	1.13	1.18	1.18
34000.1	34030.1	2.41	2.40	2.42	34000.0	2.29	2.15	2.07	1300	1.14	1.18	1.19
35000.1	35030.1	2.34	2.28	2.24	35000.0	2.99	2.71	2.52	1400	1.14	1.18	1.18
36000.1	36030.1	2.02	1.96	1.93	36000.0	3.15	2.85	2.67	1500	1.14	1.18	1.18
37000.1	37030.1	1.93	1.88	1.86	37000.0	3.39	3.01	2.75	1600	1.14	1.18	1.19
38000.1	38030.1	2.13	2.05	1.99	38000.0	3.41	2.98	2.70	1700	1.15	1.18	1.19
40000.1	40030.1	2.46	2.40	2.36	39000.0	3.01	2.71	2.52	1800	1.16	1.19	1.19
42000.1	42030.1	2.80	2.72	2.67	40000.0	3.39	2.94	2.66	1900	1.16	1.19	1.20
44000.1	44030.1	2.73	2.68	2.64	41000.0	3.61	3.10	2.78	2000	1.18	1.20	1.21
46000.1	46030.1	3.31	3.25	3.21	42000.0	3.43	3.00	2.72	3000	1.34	1.34	1.34
48000.1	48030.1	4.07	3.96	3.88	43000.0	3.24	2.79	2.51	4000	1.46	1.45	1.45
50000.1	50030.1	4.08	3.93	3.78	44000.0	2.58	2.26	2.08	5000	1.55	1.53	1.54
51000.1	51030.1	3.33	3.15	3.05	45000.0	2.16	1.94	1.83	6000	1.58	1.55	1.55
52000.1	52030.1	2.38	2.30	2.24					7000	1.63	1.60	1.60
53000.1	53030.1	1.50	1.50	1.51					8000	1.70	1.66	1.67
54000.1	54030.1	1.08	1.11	1.13					9000	1.89	1.84	1.84
55000.1	55030.1	1.69	1.66	1.64					10000	2.20	2.13	2.12
56000.1	56030.1	2.41	2.36	2.33					11000	2.56	2.47	2.45
57000.1	57030.1	2.51	2.46	2.41					12000	2.86	2.75	2.72
58000.1	58030.1	2.44	2.39	2.36					13000	2.92	2.81	2.78
59000.1	59030.1	2.03	2.01	2.00					14000	2.79	2.68	2.66
60000.1	60030.1	1.81	1.76	1.71					15000	2.76	2.64	2.61
61000.1	61030.1	1.75	1.72	1.70					16000	2.91	2.77	2.73
62000.1	62030.1	2.44	2.41	2.38					17000	3.50	3.33	3.27
63000.1	63030.1	3.13	3.07	2.99					18000	4.13	3.93	3.86
64000.1	64030.1	3.97	3.87	3.79					19000	5.37	5.12	4.99
65000.1	65030.1	4.14	4.02	3.92					20000	5.91	5.69	5.59

Frequency Mixer

ZMDB-653H-E+

Typical Performance Curves

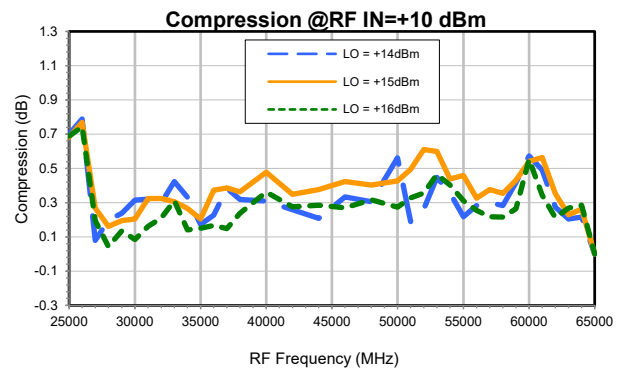
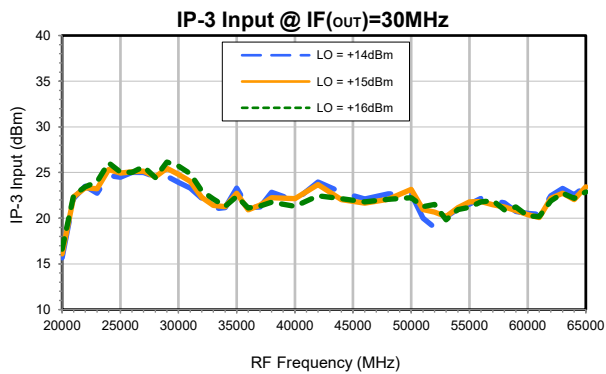
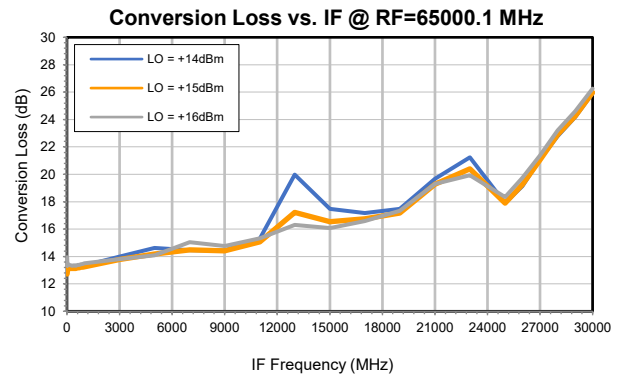
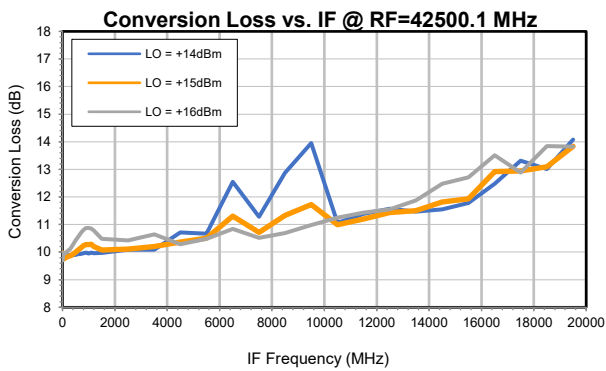
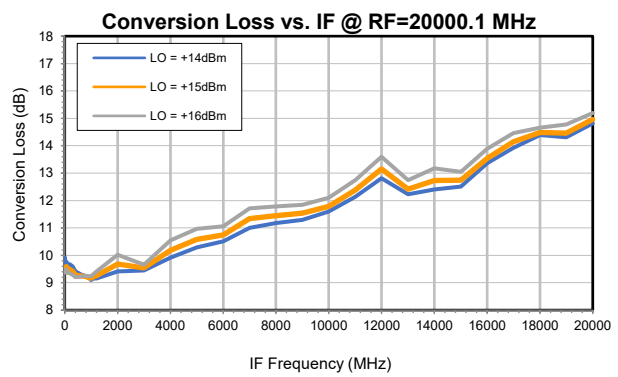
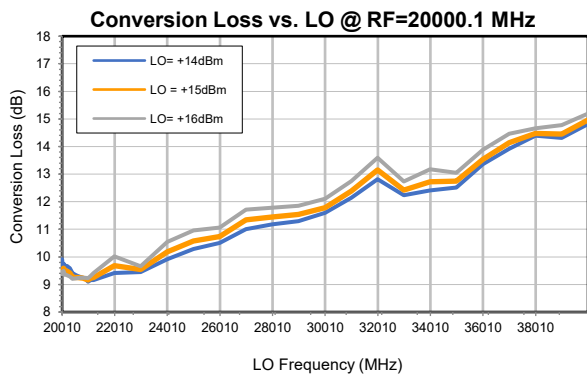
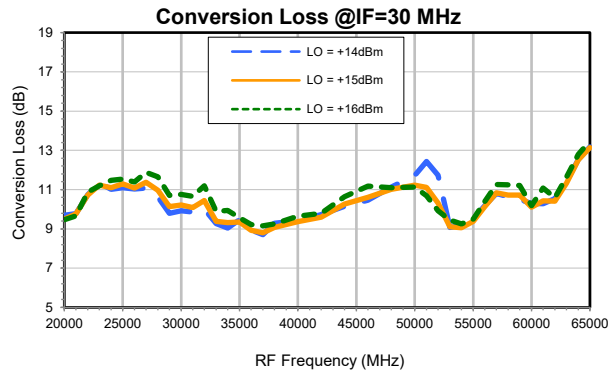

P.O. Box 350166, Brooklyn, New York 11235-0003 (718) 934-4500 • Fax (718) 332-4661 For detailed performance specs & shopping online see Mini-Circuits web site
 The Design Engineers Search Engine Provides ACTUAL Data Instantly From MINI-CIRCUITS At: www.minicircuits.com

IF/RF MICROWAVE COMPONENTS

REV. OR
 ZMDB-65H-E+
 8/29/2022
 Page 1 of 2

Frequency Mixer

ZMDB-653H-E+

Typical Performance Curves

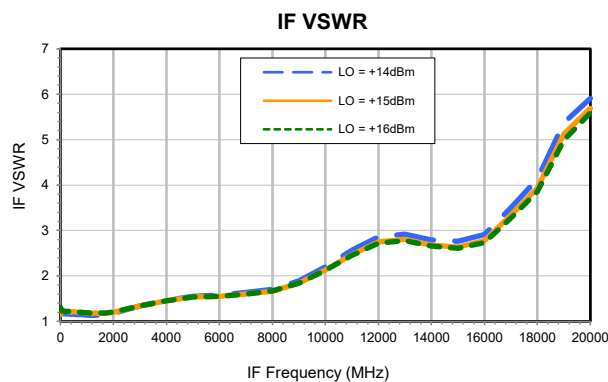
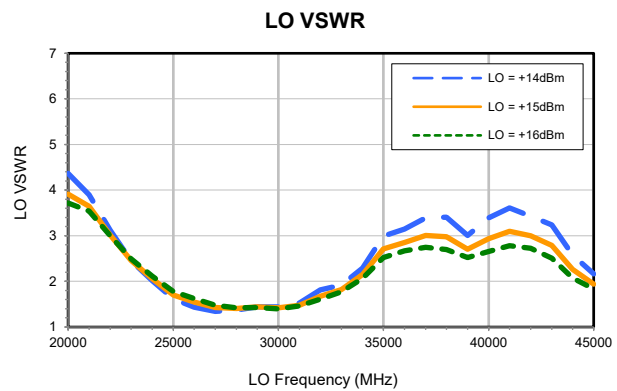
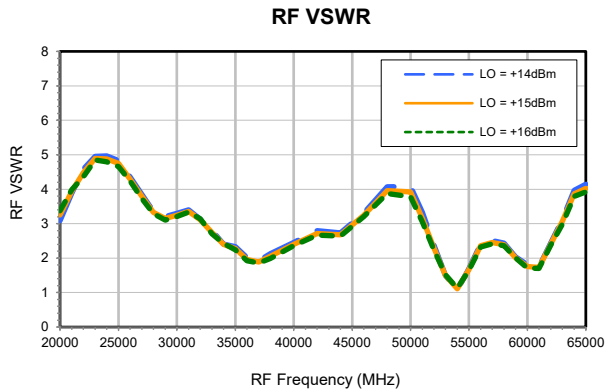
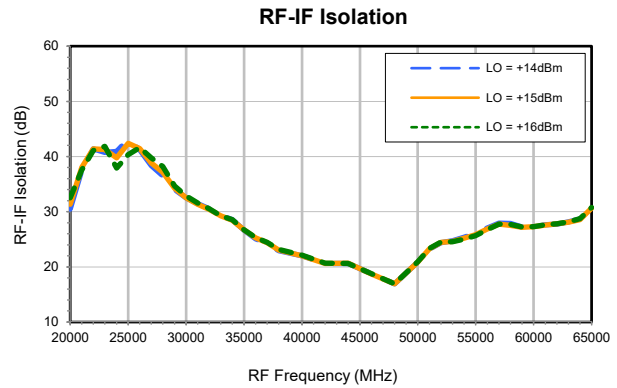
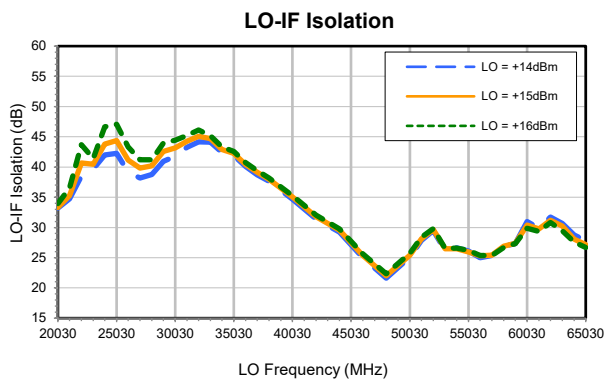
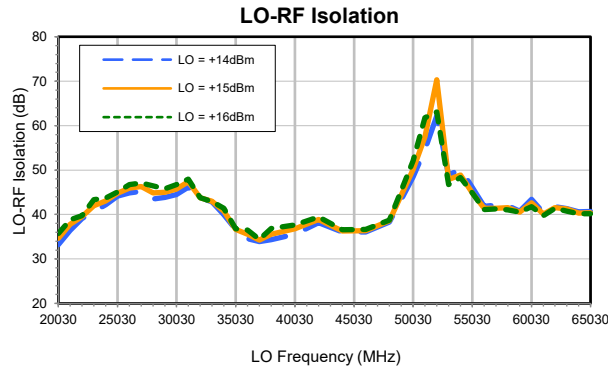

P.O. Box 350166, Brooklyn, New York 11235-0003 (718) 934-4500 • Fax (718) 332-4661 For detailed performance specs & shopping online see Mini-Circuits web site



The Design Engineers Search Engine Provides ACTUAL Data Instantly From MINI-CIRCUITS At: www.minicircuits.com

IF/RF MICROWAVE COMPONENTS

REV. OR
ZMDB-65H-E+
8/29/2022
Page 2 of 2

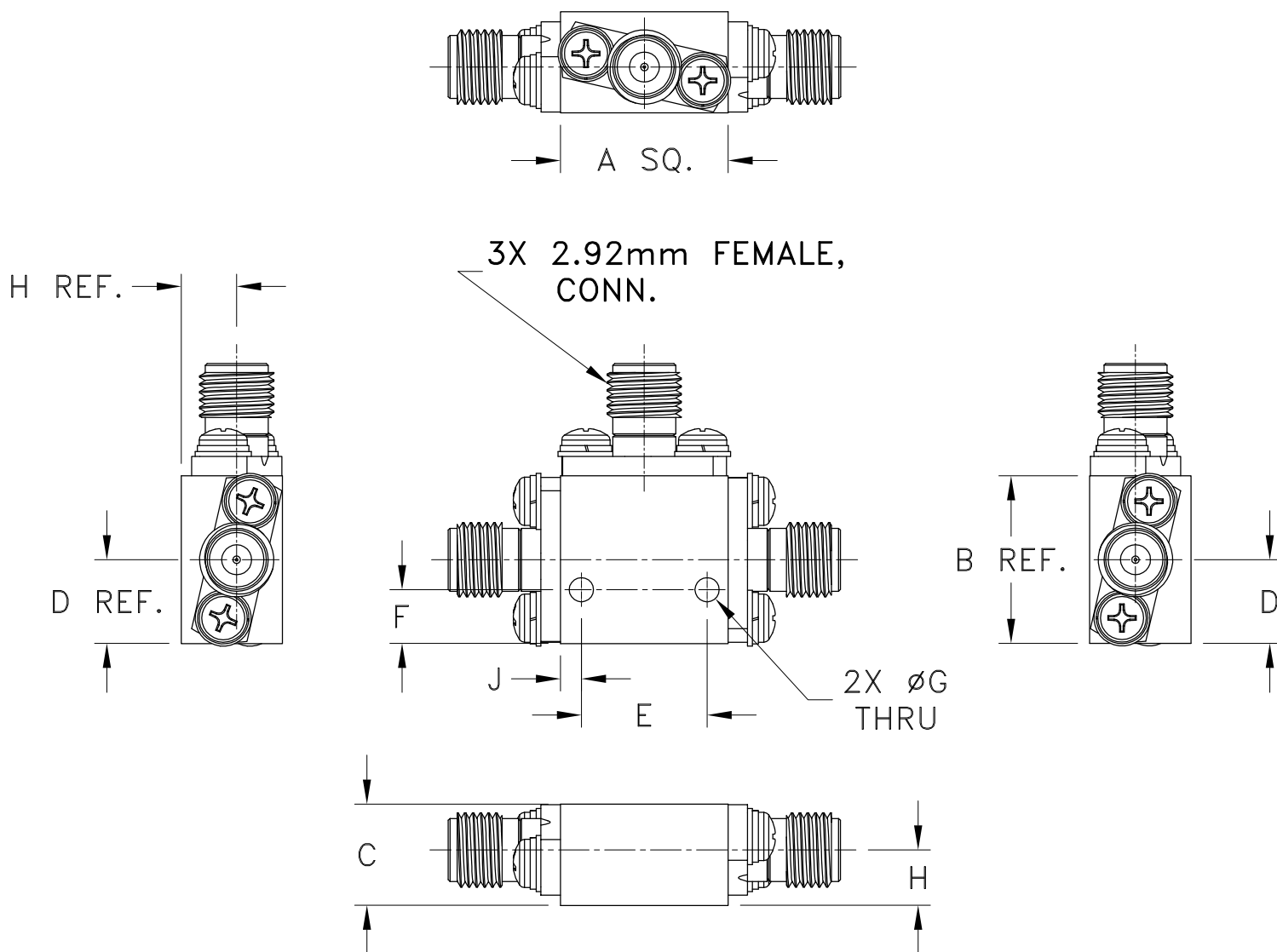

CASE#	A	B	C	D	E	F	G	H	J	WT. GRAMS
UK2938	.56 (14.2)	.56 (14.2)	.34 (8.6)	.28 (7.1)	.420 (10.67)	.18 (4.6)	.081 (2.06)	.19 (4.7)	.07 (1.8)	23.0

Dimensions are in inches (mm). Tolerances: 2 Pl.±.03; 3 Pl. ±.015

Notes:

1. Case material: Brass.
2. Case Finish: Gold plate.



P.O. Box 350166, Brooklyn, New York 11235-0003 (718) 934-4500 Fax (718) 332-4661 For detailed performance specs & shopping online see Mini-Circuits web site



The Design Engineers Search Engine Provides ACTUAL Data Instantly From MINI-CIRCUITS At: www.minicircuits.com

RF/IF MICROWAVE COMPONENTS



All Mini-Circuits products are manufactured under exacting quality assurance and control standards, and are capable of meeting published specifications after being subjected to any or all of the following physical and environmental test.

Specification	Test/Inspection Condition	Reference/Spec
Operating Temperature	-55° to 100°C Ambient Environment	Individual Model Data Sheet
Storage Temperature	-55° to 100° C Ambient Environment	Individual Model Data Sheet
Thermal Shock	-55° to 85°C, 25 cycles	MIL-STD-202F: Method 107G