



COAXIAL

High Power Amplifier

ZHL2G02G4125+ ZHL2G02G4125X+

Mini-Circuits

50Ω 2000 to 2400 MHz

THE BIG DEAL

- Saturated power, 125W typ.
- Wide bandwidth, 2000 to 2400 MHz
- High gain, 51 dB typ.
- Self-protected from overheating and reverse polarity
- Self-protected against too much reflected power
- Self-protected against too much forward power



Generic photo used for illustration purposes only

Model No.	ZHL2G02G4125+	ZHL2G02G4125X+
Case Style	BT1689	
Connectors	IN-SMA, OUT-N	

APPLICATIONS

- High power test sets
- Burn-in set-ups
- Communications
- Satcom

+RoHS Compliant

The +Suffix identifies RoHS Compliance. See our web site for RoHS Compliance methodologies and qualifications

PRODUCT OVERVIEW

The ZHL2G02G4125+ is a Class AB, high-power amplifier providing typically 125 W saturated power in the 2000 to 2400 MHz band, ideal for a variety of high-power applications such as test setups, communications, satcom and more. The ruggedly designed amplifier provides unconditional stability and built-in protection against reverse polarity, overheating, excessive amounts of forward and reflected power. The amplifier limits the output power to approximately 52dBm (158W). The amplifier's output stage can operate into and open and short and shuts off when the reflected power exceeds 100W CW. The rugged aluminum alloy enclosure measures 170 x 110 x 30 mm and features an SMA connector at the input and an N-connector at the output. A heatsink and fan attachment for cooling are optional.

KEY FEATURES

Feature	Advantages
Usable from 2000 to 2400 MHz	Suitable for a broad range of high-power applications, including test setups, communications, satcom and other applications.
High power gain, 51 dB typ.	Enables signal amplification up to 125W output power without the need for multiple gain stages.
Built-in protection	Protected from overheating, reverse polarity and excessive reflected power.
Unconditional stability	Provides reliable performance independent of input and load conditions.
Ruggedness	Able to operate into an open and short and shuts off when the reflected power exceeds 100W CW.

REV. OR
ECO-012392
ZHL2G02G4125+
MCL NY
220321





COAXIAL

High Power Amplifier

ZHL2G02G4125+ ZHL2G02G4125X+

ELECTRICAL SPECIFICATIONS AT T_(MOUNTING BASE)=25°C

Parameter	Symbol	Condition (MHz)	Min.	Typ.	Max.	Units
Frequency Range	f		2000		2400	MHz
Output power @ 1dB compression	P _{1dB}	f=2000-2400MHz	49	49.5		dBm
			80	90		W
Output power @ 3dB compression	P _{3dB}	f=2000-2120MHz	51			dBm
			125			W
		f=2120-2400MHz	50			dBm
			100			W
Small Signal Gain	G _{SS}	f=2000-2400MHz, P _{IN} =-50dBm	47	52	57	dB
Small Signal Gain Flatness	G _{SS-FLAT}	f=2000-2400MHz, P _{IN} =-50dBm		± 1.0	± 1.5	dB
Power Gain	G _P	f=2000-2400MHz, P _{OUT} =P1dB	46	51	55	dB
Power Gain Flatness	G _{P-FLAT}	f=2000-2400MHz, P _{OUT} =P1dB		± 1.0	± 1.5	dB
Noise Figure	NF	f=2000-2400MHz		7		dB
Input VSWR	S11	f=2000-2400MHz, P _{IN} =-50dBm			2.0:1	-
Non-Harmonic Spurious Signals	Spur	P _{OUT} =49dBm		<-60		dBc
DC Supply Voltage	V _{SUPPLY}			28 ¹	30	V
DC Supply Current	I _{SUPPLY}			16	17	A

1. Typical spec is recommended operating voltage

MAXIMUM RATINGS

Parameter	Ratings
Operating Mounting Base Temperature ⁽¹⁾	-20°C to +80°C
Storage Temperature	-55°C to +100°C
PIN Maximum (No Damage)	+20 dBm
Max. Supply Voltage, Reverse Polarity	-30V
Max. Supply Voltage, Reverse Polarity	-30V

1. Mounting Base is the bottom of the amplifier enclosure which attaches to heatsink.

PROTECTIONS

Parameter	Ratings
Mounting Base Temperature	+90°C ± 5°C
Excessive forward power	Limits P _{OUT} to approximately 52dBm (158W)
Output Load Mismatch	No damage with an open or short, shuts off when P _{REFLECTED} exceeds 50dBm ± 1dB





COAXIAL

High Power Amplifier

ZHL2G02G4125+
ZHL2G02G4125X+

OUTLINE DRAWING

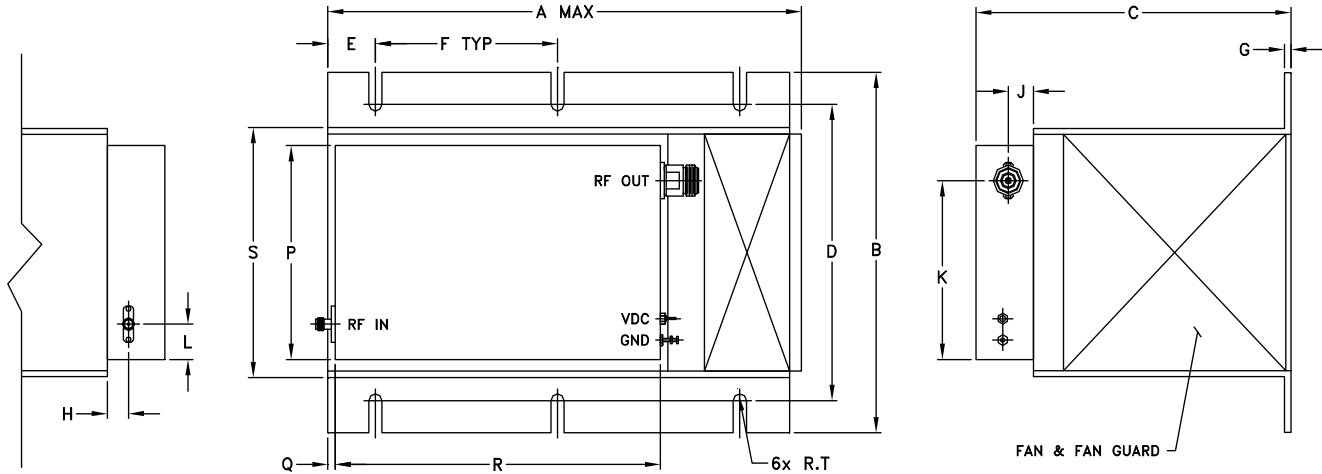

MOUNTING INFORMATION FOR MODELS WITHOUT HEATSINK

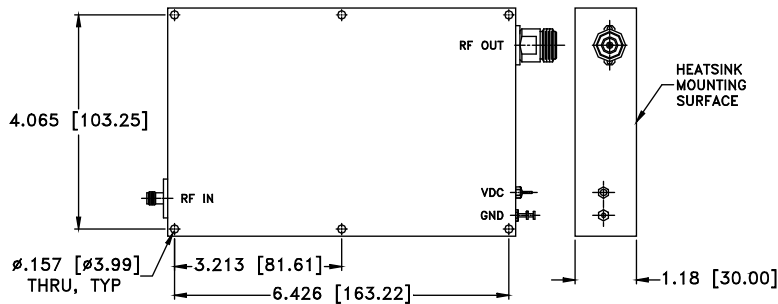

OUTLINE DIMENSIONS (Inch/mm)

CASE#	A	B	C	D	E	F	G	H	J	K	L	M	N
BT1689	9.85 (250.19)	7.3 (185.42)	6.5 (165.10)	6.00 (152.40)	.98 (24.89)	3.75 (95.25)	.13 (3.30)	.43 (11.0)	.51 (13.00)	3.62 (91.85)	.72 (18.29)	-	-

CASE#	P	Q	R	S	T	WT, GRAM	WT WITHOUT HEATSINK, GRAM
BT1689	4.33 (109.98)	.2 (5.08)	6.69 (169.93)	5.1 (129.54)	.136 (3.45)	4565	880

Dimensions in inches [mm]. Tolerances: 1 Pl. + .1; 2 Pl. + .03; 3 Pl. + .015





COAXIAL

High Power Amplifier

ZHL2G02G4125+ ZHL2G02G4125X+

TYPICAL PERFORMANCE CURVES @ $V_{DS}=28V$

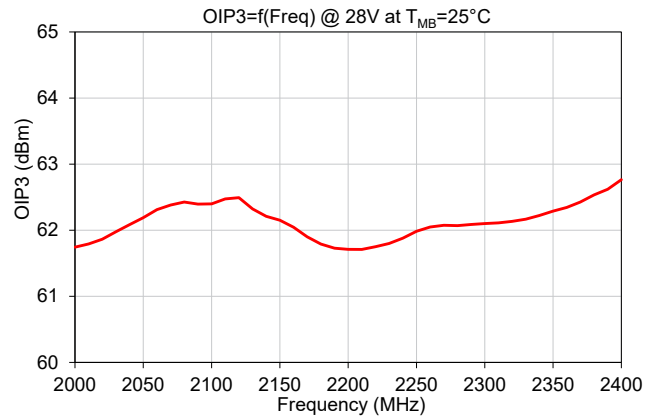
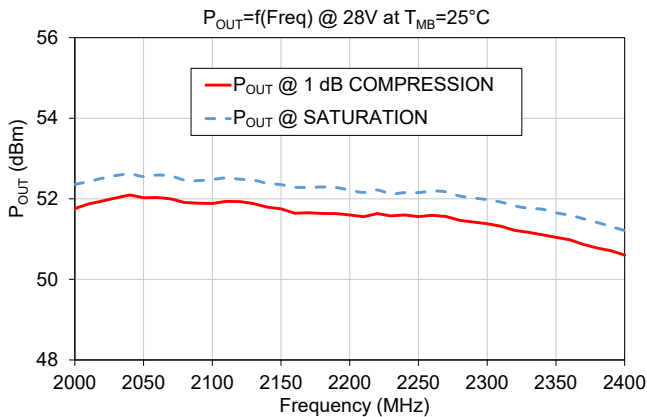
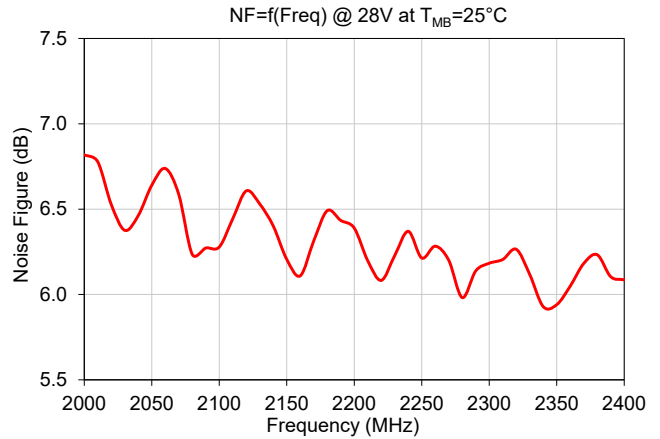
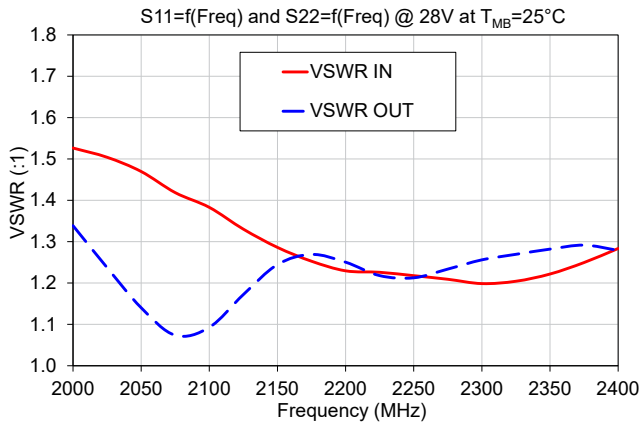
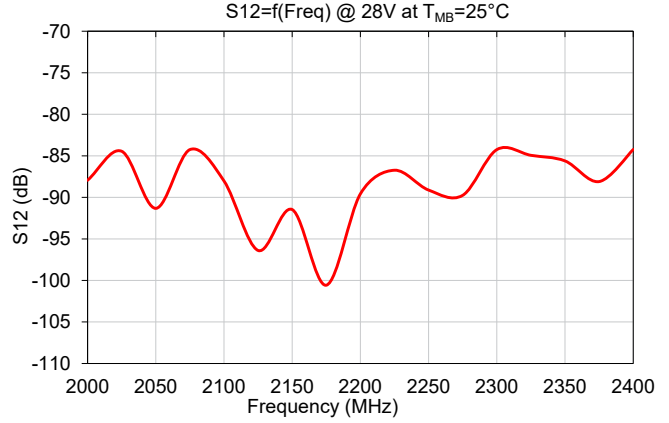
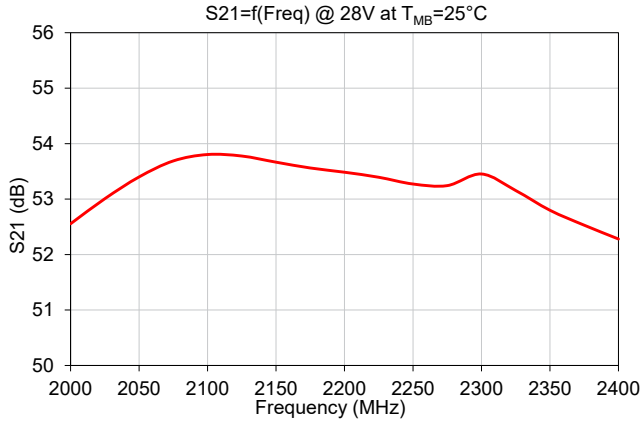



COAXIAL

High Power Amplifier

ZHL2G02G4125+ ZHL2G02G4125X+

TYPICAL PERFORMANCE CURVES @ $V_{DS}=28V$

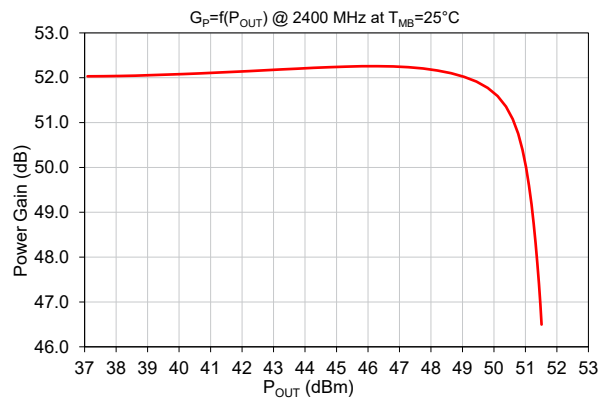
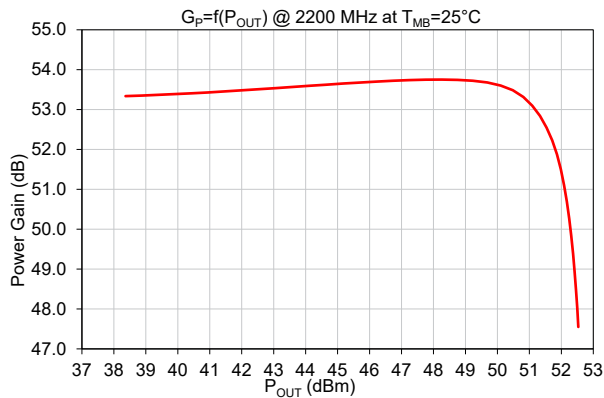
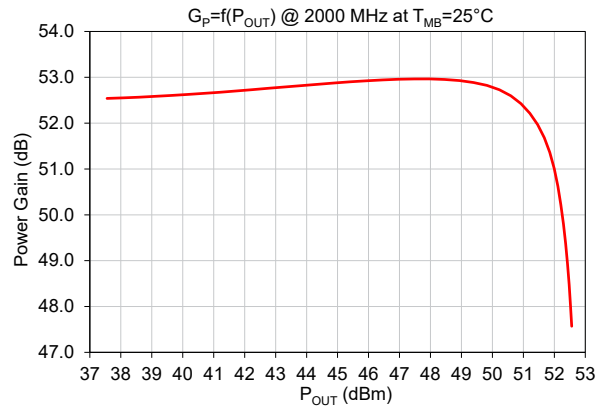
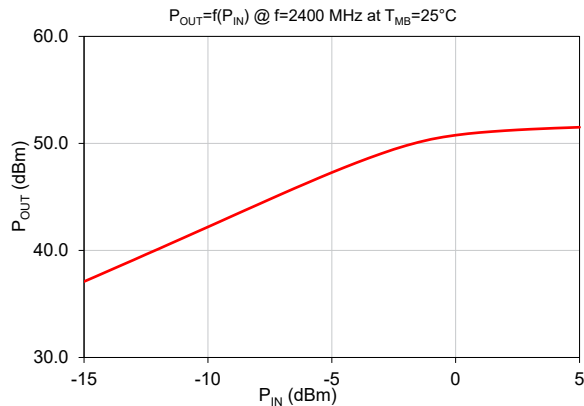
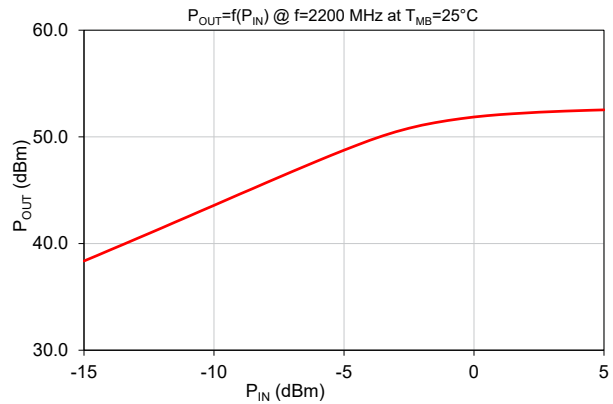
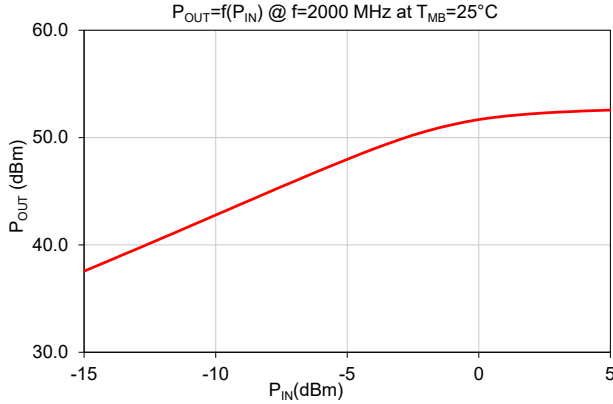

- NOTES**
- A. Performance and quality attributes and conditions not expressly stated in this specification document are intended to be excluded and do not form a part of this specification document.
 - B. Electrical specifications and performance data contained in this specification document are based on Mini-Circuit's applicable established test performance criteria and measurement instructions.
 - C. The parts covered by this specification document are subject to Mini-Circuits standard limited warranty and terms and conditions (collectively, "Standard Terms"); Purchasers of this part are entitled to the rights and benefits contained therein. For a full statement of the standard. Terms and the exclusive rights and remedies thereunder, please visit Mini-Circuits' website at www.minicircuits.com/terms/viewterm.html



Outline Dimensions

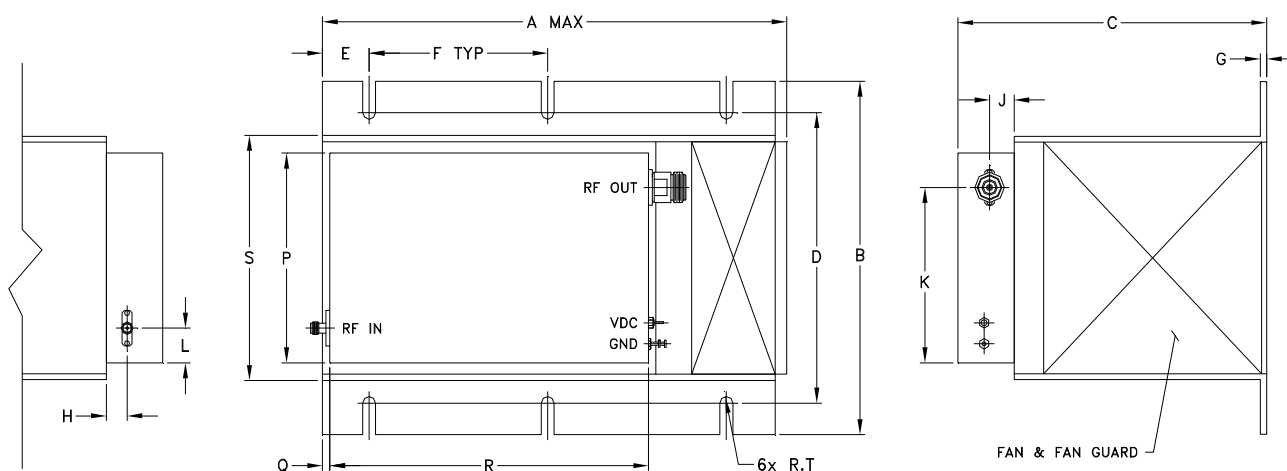

MOUNTING INFORMATION FOR MODELS WITHOUT HEATSINK

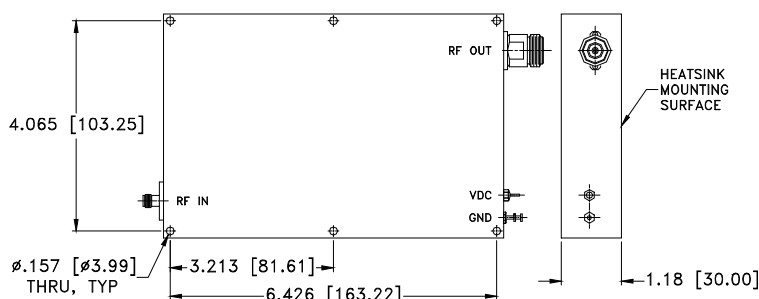

CASE#	A	B	C	D	E	F	G	H	J	K	L	M	N
BT1689	9.85 (250.19)	7.3 (185.42)	6.5 (165.10)	6.00 (152.40)	.98 (24.89)	3.75 (95.25)	.13 (3.30)	.43 (11.0)	.51 (13.00)	3.34 (84.83)	.72 (18.29)	-	-

CASE#	P	Q	R	S	T	WT, GRAM	WT WITHOUT HEATSINK, GRAM
BT1689	4.33 (109.98)	.2 (5.08)	6.69 (169.93)	5.1 (129.54)	.136 (3.45)	4565	880

Dimensions in inches (mm). Tolerances: 1 Pl. $\pm .1$; 2Pl. $\pm .03$; 3 Pl. $\pm .015$

Notes:

- Case material: Aluminum alloy.
- Finish:
For RoHS Case Styles: Clear Chemical conversion coating, non-chrome or trivalent chrome based.
- Heatsink finish: Black anodize.
- Refer to the individual model data sheet for the type of connectors available.
- Recommended screws for mounting model without heat sink on 3/32" thick sheet: #6-32, 1.50" Length.
- Shape of connector flange may vary.



P.O. Box 350166, Brooklyn, New York 11235-0003 (718) 934-4500 Fax (718) 332-4661 For detailed performance specs & shopping online see Mini-Circuits web site



The Design Engineers Search Engine Provides ACTUAL Data Instantly From MINI-CIRCUITS At: www.minicircuits.com

RF/IF MICROWAVE COMPONENTS



All Mini-Circuits products are manufactured under exacting quality assurance and control standards, and are capable of meeting published specifications after being subjected to any or all of the following physical and environmental test.

Specification	Test/Inspection Condition	Reference/Spec
Operating Temperature	-20° to +80° C	Individual Model Data Sheet
Storage Temperature	-55° to 100° C Ambient Environment	Individual Model Data Sheet
Stabilization Bake	(Non-operating) 125°C, 24 hours	- - -
DC Burn-in	(DC on) 112 hours at 80°C	---
Thermal Shock	-55°C to +100°C, 100 cycles, 15 mins dwell at extreme temperatures	MIL-STD-202, Method 107
Thermal Imaging	With Output open, short and load conditions	---
Vibration	Category 24, Exposure level figure 514C-17. General use, Random Vibration, 1 hr/axis 20-1000Hz - Amplitude PSD (0.040 G ² /Hz). 1000 to 2000 Hz - Amplitude PSD (-6dB/octave)	MIL-STD-810F Method 514.5
Mechanical Shock	Terminal peak sawtooth, 40G's, 11 ms, 3 shocks +/-, Each Axis, 18 Shock Pulses Total	MIL-STD-810F Method 516.5