



COAXIAL High Power Amplifier

ZHL-20W-13+ ZHL-20W-13X+

50Ω 20W 20 to 1000 MHz

FEATURES

- High Power, 20 Watt
- Protected against overheat -shuts off automatically
- Excellent Gain Flatness, ± 1.2 dB typ.
- Class A amplifier
- Usable over 15 to 1100 MHz
- Protected by US patent 7,348,854



Generic photo used for illustration purposes only

Model No.	ZHL-20W-13+	ZHL-20W-13X+▲
Case Style	CP641	
Connectors	SMA	

+RoHS Compliant

The +Suffix identifies RoHS Compliance.
See our website for methodologies and qualifications

APPLICATIONS

- VHF/UHF Transmitters
- Defense
- Amateur Radio, FM, TV

ELECTRICAL SPECIFICATIONS

Parameter	Min.	Typ.	Max.	Units
Frequency Range	20		1000	MHz
Gain	46	50	55	dB
Gain Flatness			± 1.8	dB
Output Power at 1dB compression	+39	+41		dBm
Saturated Output Power at 3dB compression	+40	+43		dBm
Noise Figure		3.5		dB
Output third order intercept point		+50		dBm
Input VSWR		1.7		:1
Output VSWR		2.5		:1
DC Supply Voltage		24		V
Supply Current			2.8	A

Open load is not recommended, potentially can cause damage.
With no load derate max. input power by 20dB.

▲ Heat sink and fan not included. Alternative heat sinking and heat removal must be provided by the user to limit maximum base-plate temperature to 85°C, in order to ensure proper performance. For reference, this requires thermal resistance of user's external heat sink to be 0.38°C/W max.

ABSOLUTE MAXIMUM RATINGS

Parameter	Ratings
Operating Temperature	-20°C to +65°C
Storage Temperature	-55°C to +100°C
Base Plate Temperature	+85°C
DC Voltage	+28V
Input RF Power ¹ (no damage)	-3 dBm

Permanent damage may occur if any of these limits are exceeded.

1. At nominal 50 Ohms RF load. Amplifier can withstand a full mismatch (short or open) across all phases at RF output, if the input RF power does not exceed -13dBm. Maximum RF input power is defined as a peak envelope power (PEP). See the application note AN-60-037 for PEP calculation.





COAXIAL High Power Amplifier

ZHL-20W-13+ ZHL-20W-13X+

Mini-Circuits

50Ω 20W 20 to 1000 MHz

OUTLINE DRAWING

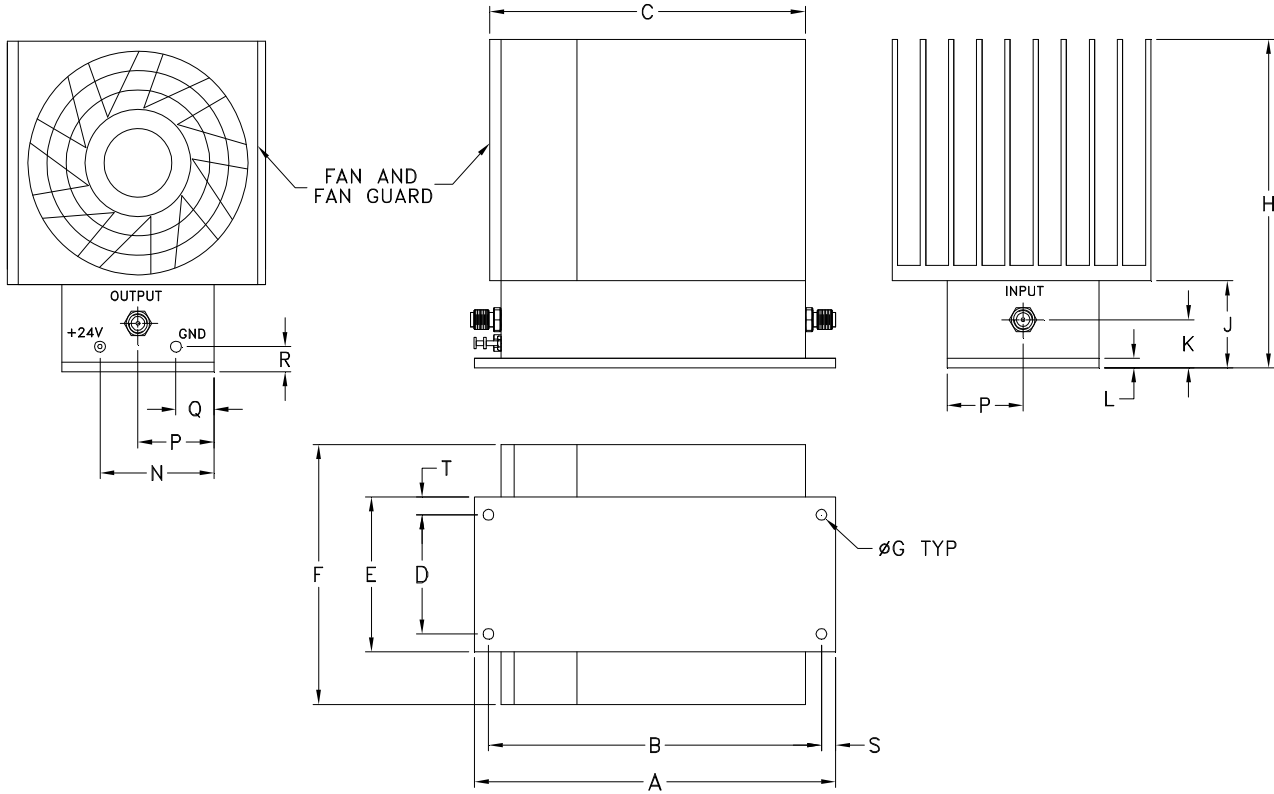

MOUNTING INFORMATION OF MODEL WITHOUT HEATSINK

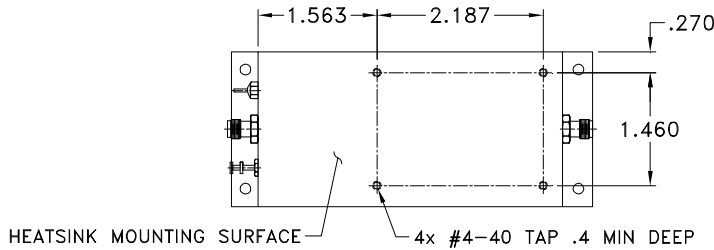

OUTLINE DIMENSIONS (Inch/mm)

A	B	C	D	E	F	G	H	J	K	L	M	N	P	Q	R	S	T	wt
4.75	4.375	4.18	1.540	2.00	3.36	.144	4.24	1.12	.58	.125	--	1.50	1.00	.50	.34	.19	.23	grams*
120.65	111.13	106.17	39.12	50.80	85.34	3.66	107.70	28.45	14.73	3.18	--	38.10	25.40	12.70	8.64	4.83	5.84	750
																		*290 grams without heatsink





COAXIAL High Power Amplifier

ZHL-20W-13+ ZHL-20W-13X+

50Ω 20W 20 to 1000 MHz

TYPICAL PERFORMANCE DATA AND CHARTS

FREQUENCY (MHz)	GAIN (dB)	VSWR (:1)		NOISE FIGURE (dB)	POUT at 1 dB COMPR. (dBm)	OIP3 (dBm)
		IN	OUT			
20	51.98	1.31	2.20	3.84	42.41	52.67
40	51.82	1.27	2.21	3.76	42.89	53.14
60	51.75	1.26	2.27	3.92	42.81	53.13
80	51.65	1.28	2.36	3.91	42.96	53.25
100	51.60	1.29	2.48	4.06	43.04	53.29
200	51.30	1.36	3.09	4.34	43.19	52.59
250	51.28	1.38	3.24	4.12	42.81	51.99
300	51.33	1.39	3.20	3.95	42.54	51.58
350	51.50	1.38	2.99	3.77	42.34	51.68
450	51.96	1.37	2.30	3.90	42.14	52.77
500	52.21	1.34	2.00	3.74	42.30	51.70
550	52.41	1.33	1.80	3.83	42.30	50.53
600	52.61	1.29	1.73	3.85	42.22	49.93
650	52.77	1.25	1.76	3.89	42.10	49.41
750	52.77	1.16	1.96	3.90	41.93	48.86
800	52.45	1.12	2.11	3.84	41.78	48.44
850	51.95	1.11	2.27	3.78	41.72	48.10
900	51.26	1.10	2.40	3.76	41.64	47.73
950	50.78	1.09	2.32	3.74	41.32	47.13
1000	50.81	1.08	2.12	3.72	41.03	47.53

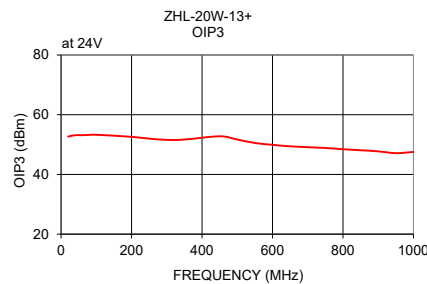
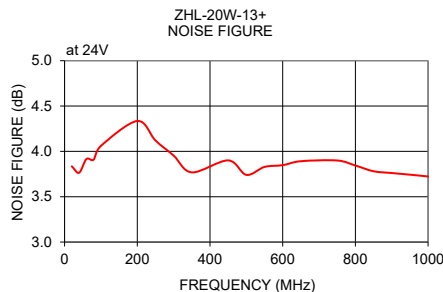
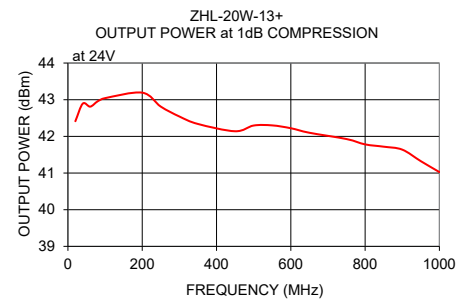
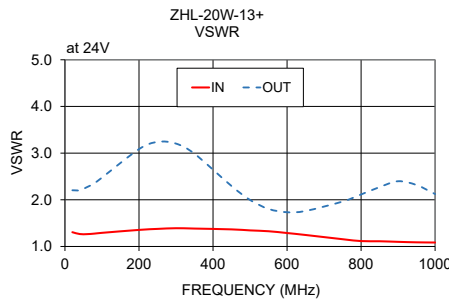
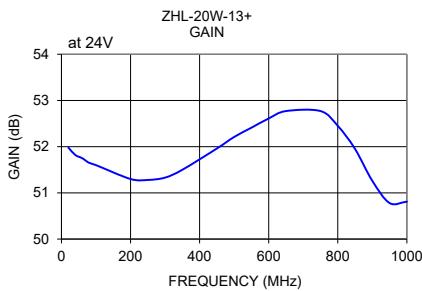

NOTES

- Performance and quality attributes and conditions not expressly stated in this specification document are intended to be excluded and do not form a part of this specification document.
- Electrical specifications and performance data contained in this specification document are based on Mini-Circuit's applicable established test performance criteria and measurement instructions.
- The parts covered by this specification document are subject to Mini-Circuits standard limited warranty and terms and conditions (collectively, "Standard Terms"); Purchasers of this part are entitled to the rights and benefits contained therein. For a full statement of the standard terms and the exclusive rights and remedies thereunder, please visit Mini-Circuits' website at www.minicircuits.com/terms/viewterm.html



Typical Performance Data

Frequency	GAIN	Directivity	VSWR In	VSWR Out	Noise Figure	Pout at 1dB Compression	Output IP3
(MHz)	(dB) 24V	(dB) 24V	(:1) 24V	(:1) 24V	(dB) 24V	(dBm) 24V	(dBm) 24V
20	51.98	34.47	1.31	2.20	3.84	42.41	52.67
30	51.86	32.52	1.27	2.19	3.81	42.72	53.03
40	51.82	30.40	1.27	2.21	3.76	42.89	53.14
50	51.76	34.78	1.27	2.23	3.86	42.73	53.09
60	51.75	34.22	1.26	2.27	3.92	42.81	53.13
70	51.68	33.63	1.27	2.31	3.96	42.80	53.18
80	51.65	37.38	1.28	2.36	3.91	42.96	53.25
90	51.61	35.84	1.28	2.41	4.06	42.95	53.15
100	51.60	34.57	1.29	2.48	4.06	43.04	53.29
125	51.50	36.98	1.31	2.64	4.15	43.10	53.17
150	51.40	35.67	1.33	2.80	4.24	43.18	53.07
175	51.37	34.78	1.35	2.95	4.32	43.26	52.88
200	51.30	35.49	1.36	3.09	4.34	43.19	52.59
225	51.26	36.11	1.37	3.18	4.33	43.02	52.33
250	51.28	33.58	1.38	3.24	4.12	42.81	51.99
275	51.31	37.73	1.38	3.25	4.05	42.62	51.80
300	51.33	35.92	1.39	3.20	3.95	42.54	51.58
325	51.40	36.41	1.38	3.12	3.87	42.40	51.55
350	51.50	37.31	1.38	2.99	3.77	42.34	51.68
375	51.63	36.58	1.38	2.83	3.69	42.36	51.84
400	51.72	42.00	1.38	2.66	3.84	42.19	52.42
425	51.85	39.27	1.37	2.47	4.03	42.08	52.81
450	51.96	39.71	1.37	2.30	3.90	42.14	52.77
475	52.09	36.97	1.36	2.13	3.73	42.18	52.25
500	52.21	39.55	1.34	2.00	3.74	42.30	51.70
525	52.31	39.79	1.34	1.89	3.75	42.27	51.10
550	52.41	37.51	1.33	1.80	3.83	42.30	50.53
575	52.51	34.75	1.30	1.75	3.85	42.31	50.15
600	52.61	34.74	1.29	1.73	3.85	42.22	49.93
625	52.70	34.98	1.27	1.74	3.86	42.21	49.66
650	52.77	33.65	1.25	1.76	3.89	42.10	49.41
675	52.85	32.78	1.23	1.80	3.86	42.04	49.25
700	52.86	34.33	1.20	1.85	3.89	41.94	49.13
725	52.85	32.52	1.18	1.90	3.88	41.91	48.98
750	52.77	31.13	1.16	1.96	3.90	41.93	48.86
775	52.54	30.78	1.11	2.03	3.89	41.83	48.62
800	52.45	31.12	1.12	2.11	3.84	41.78	48.44
825	52.24	31.05	1.12	2.20	3.80	41.85	48.28
850	51.95	32.60	1.11	2.27	3.78	41.72	48.10
875	51.60	32.66	1.10	2.35	3.80	41.68	47.92
900	51.26	30.99	1.10	2.40	3.76	41.64	47.73
925	50.98	31.92	1.10	2.41	3.74	41.43	47.42
950	50.78	31.62	1.09	2.32	3.74	41.32	47.13
975	50.73	31.42	1.07	2.25	3.75	41.07	46.97
1000	50.81	31.11	1.08	2.12	3.72	41.03	47.53

Typical Performance Curves

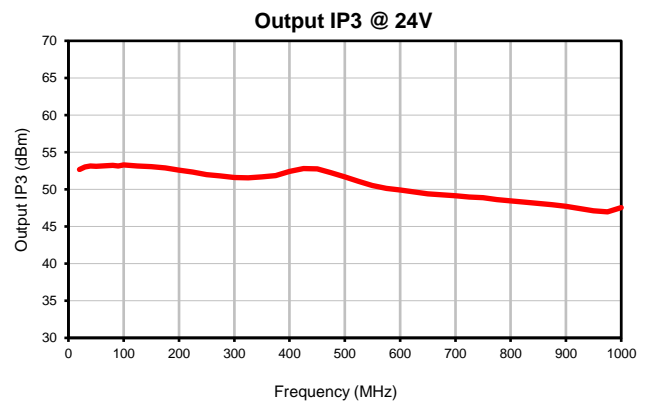
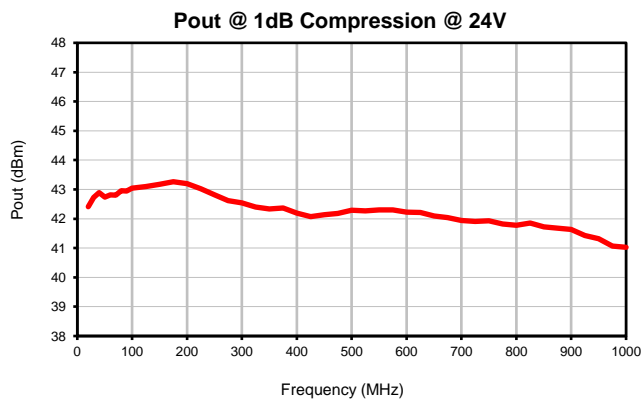
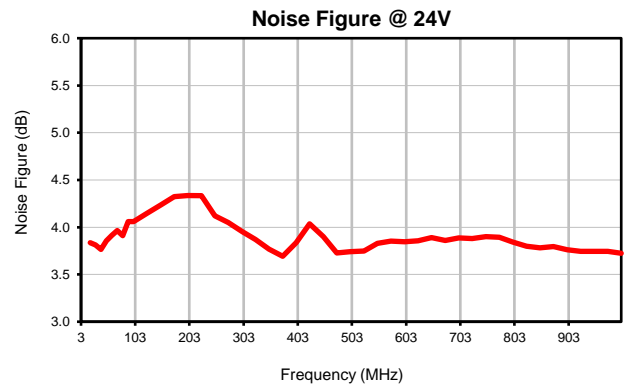
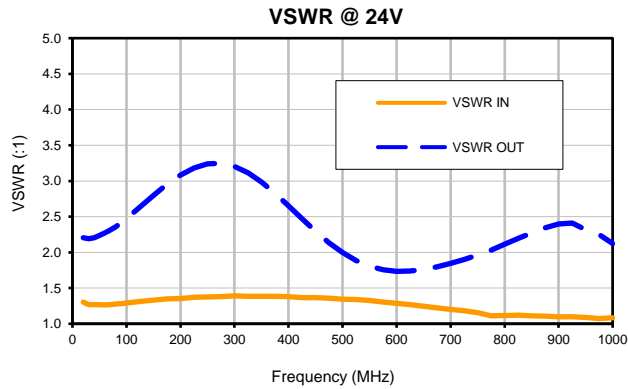
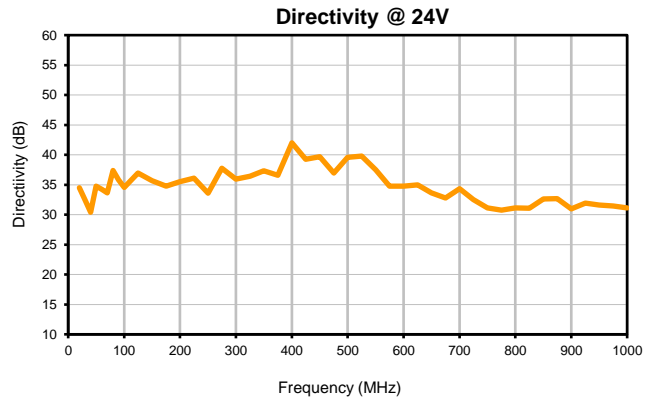
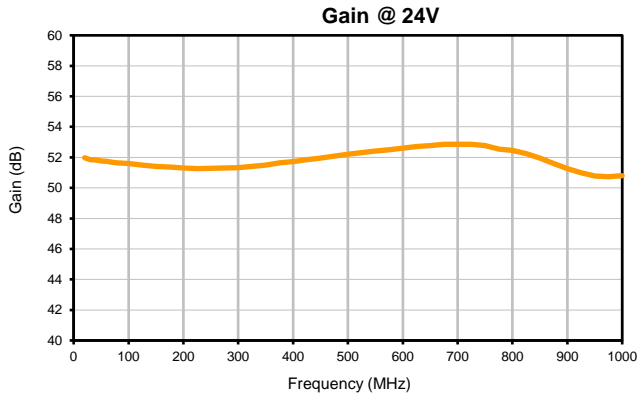

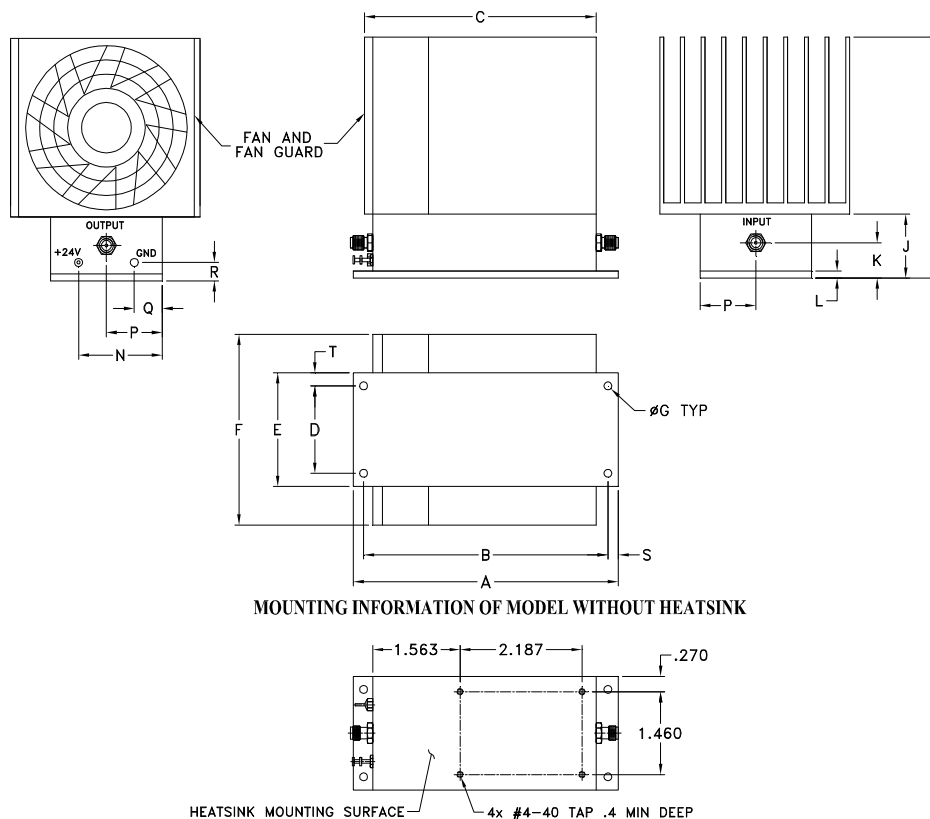

CASE#	A	B	C	D	E	F	G	H	J	K	L	M	N
CP641	4.75 (120.65)	4.375 (111.13)	4.18 (106.17)	1.540 (39.12)	2.00 (50.80)	3.36 (85.34)	.144 (3.66)	4.24 (107.70)	1.12 (28.45)	.58 (14.73)	.125 (3.18)	-- --	1.50 (38.10)

CASE#	P	Q	R	S	T	WT. GRAMS	WT. WITHOUT HEATSINK GRAMS
CP641	1.00 (25.40)	.50 (12.70)	.34 (8.64)	.19 (4.83)	.23 (5.84)	750	290

Dimensions are in inches (mm). Tolerances: 2 Pl. $\pm .03$; 3 Pl. $\pm .015$

Notes:

- Case material: Aluminum alloy.
- Case finish:
For RoHS Case Styles: Clear chemical conversion coating, non-chrome or trivalent chrome based.
- Heat sink finish: Black anodize if supplied with heat sink.



P.O. Box 350166, Brooklyn, New York 11235-0003 (718) 934-4500 Fax (718) 332-4661 For detailed performance specs & shopping online see Mini-Circuits web site



The Design Engineers Search Engine Provides ACTUAL Data Instantly From MINI-CIRCUITS At: www.minicircuits.com

RF/MICROWAVE COMPONENTS



All Mini-Circuits products are manufactured under exacting quality assurance and control standards, and are capable of meeting published specifications after being subjected to any or all of the following physical and environmental test.

Specification	Test/Inspection Condition	Reference/Spec
Operating Temperature	-20° to 80° C Ambient Environment	Individual Model Data Sheet
Storage Temperature	-55° to 100° C Ambient Environment	Individual Model Data Sheet
Stabilization Bake	(non-operating) 125°C, 24 hours	- - -
Burn-in at Elevated Temp.	(DC on) 160 hours at 85° C	MIL-STD-202, Method 108
Thermal Shock	-55° to 100°C, 5 cycles	MIL-STD-202, Method 107, Condition A, except 100°C