



COAXIAL

Low Noise Amplifier

ZHL-1724HLN+ ZHL-1724HLNX+

50Ω 1700 to 2400 MHz

FEATURES

- Very Low Noise Figure, 1.5 dB max.
- Wideband, 1700 to 2400 MHz
- High Dynamic Range

APPLICATIONS

- PCS/DCS
- UMTS
- Communication Systems

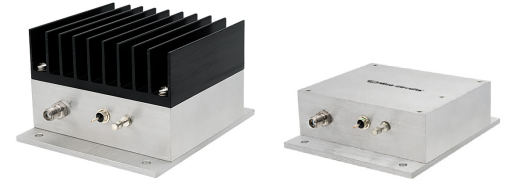

Generic photo used for illustration purposes only

Model No.	ZHL-1724HLN+	ZHL-1724HLNX+▲
Case Style	NN92	
Connectors	SMA	

+RoHS Compliant
 The +Suffix identifies RoHS Compliance.
 See our website for methodologies and qualifications

ELECTRICAL SPECIFICATIONS AT 25°C

Parameter	Frequency (MHz)	ZHL-1724HLN-S+			ZHL-1724HLNX-S+ ▲			Units
		Min.	Typ.	Max.	Min	Typ.	Max.	
Frequency Range		1700		2400	1700		2400	MHz
Noise Figure ¹	1700-2400	—	1.10	1.5	—	1.10	1.5	dB
Gain	1700-2400	30	36	—	30	36	—	dB
Gain Flatness	1700-2400	—	0.7	±1.0	—	0.7	±1.0	dB
Output Power at 1dB compression	1700-2400	—	+26	—	—	+26	—	dBm
Output third order intercept point	1700-2400	—	+36	—	—	+36	—	dBm
Input VSWR	1700-2400	—	1.4	—	—	1.4	—	:1
Output VSWR	1700-2400	—	1.6	—	—	1.6	—	:1
DC Supply Voltage		—	15	—	—	15	—	V
Supply Current ¹		—	580	725	—	580	725	mA

1. Noise Figure specified at room temperature, increases to 2.3 dB max. at +65°C
 Open load is not recommended, potentially can cause damage.
 With no load derate max input power by 20 dB

▲ Heat sink not included. Alternative heat sinking and heat removal must be provided by the user to limit maximum base-plate temperature to 65°C, in order to ensure proper performance. For reference, this requires thermal resistance of user's external heat sink to be 1.8°C/W max.

ABSOLUTE MAXIMUM RATINGS

Parameter	Ratings
Operating Temperature	-20°C to +65°C
Storage Temperature	-55°C to +100°C
DC Voltage	+20V
Input RF Power (no damage)	+10 dBm

Permanent damage may occur if any of these limits are exceeded.

REV. B
 ECO-018348
 ZHL-1724HLN+
 MCL NY
 230626





COAXIAL

Low Noise Amplifier

ZHL-1724HLN+ ZHL-1724HLNX+

Mini-Circuits

50Ω 1700 to 2400 MHz

OUTLINE DRAWING FOR MODELS WITH HEATSINK

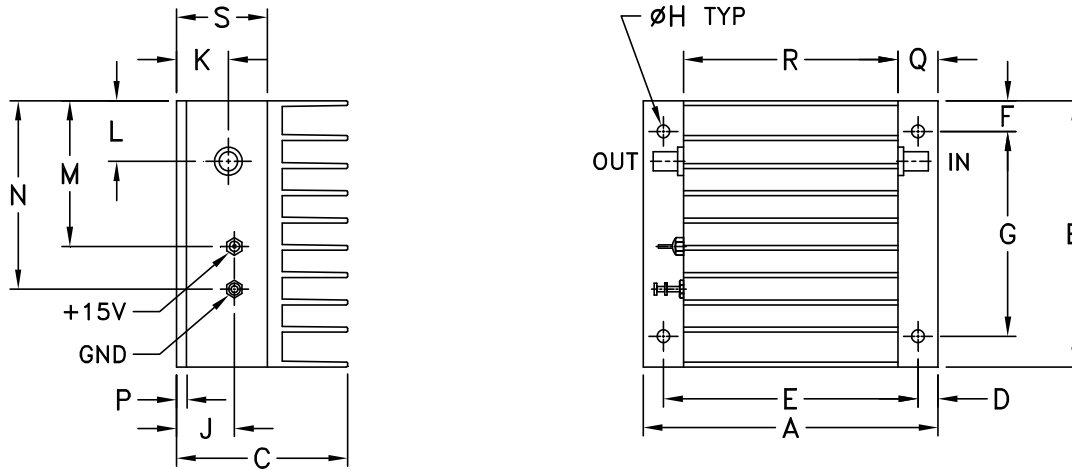

MOUNTING INFORMATION FOR MODELS WITHOUT HEATSINK

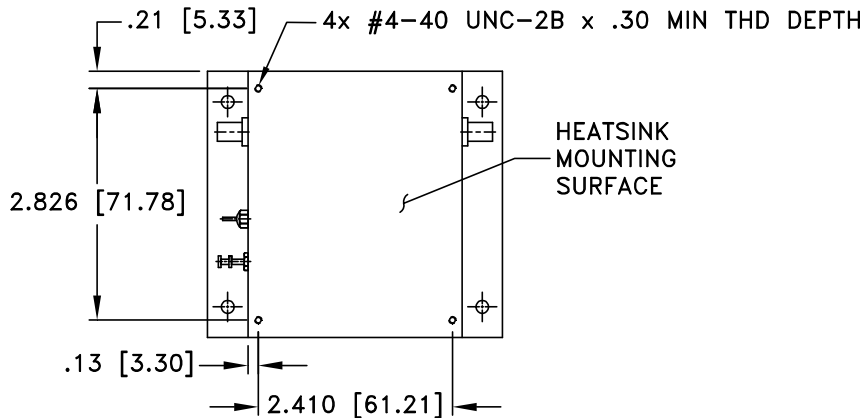

OUTLINE DIMENSIONS (Inch/mm)

A	B	C	D	E	F	G	H	J	K	L	M	N	P	Q	R	S	wt
3.66	3.25	2.13	.25	3.16	.38	2.50	.156	.72	.64	.74	1.78	2.30	.125	.50	2.66	1.13	grams*
92.96	82.55	54.10	6.35	80.26	9.65	63.50	3.96	18.29	16.26	18.80	45.21	58.42	3.18	12.70	67.56	28.7	500.0

*362 grams without heatsink





COAXIAL

Low Noise Amplifier

ZHL-1724HLN+ ZHL-1724HLNX+

Mini-Circuits

50Ω 1700 to 2400 MHz

TYPICAL PERFORMANCE DATA/CURVES

FREQUENCY (MHz)	GAIN (dB)	DIRECTIVITY (dB)	VSWR (:1)		POUT at 1 dB COMPR. (dBm)	NOISE FIGURE (dB)	IP3 (dBm)
	15V	15V	IN	OUT	15V	15V	15V
1700	35.99	51.99	1.39	1.16	26.41	1.08	37.48
1750	36.17	50.14	1.35	1.23	26.48	1.09	37.75
1800	36.26	45.24	1.32	1.29	26.60	1.12	38.18
1850	36.30	46.87	1.29	1.36	26.71	1.08	38.57
1900	36.30	45.92	1.27	1.43	26.80	1.08	38.76
1950	36.29	44.73	1.26	1.48	26.95	1.08	39.12
2000	36.27	45.02	1.24	1.52	27.02	1.12	39.42
2050	36.21	46.87	1.22	1.56	27.10	1.11	39.28
2100	36.13	43.80	1.20	1.58	27.13	1.24	39.35
2150	36.03	48.41	1.16	1.59	27.14	1.23	39.06
2200	35.91	48.46	1.13	1.59	27.16	1.22	39.03
2250	35.79	48.96	1.09	1.58	27.27	1.19	38.50
2300	35.70	53.65	1.07	1.56	27.34	1.19	38.62
2350	35.65	50.89	1.06	1.52	27.48	1.20	38.46
2400	35.59	59.49	1.07	1.49	27.66	1.29	38.54

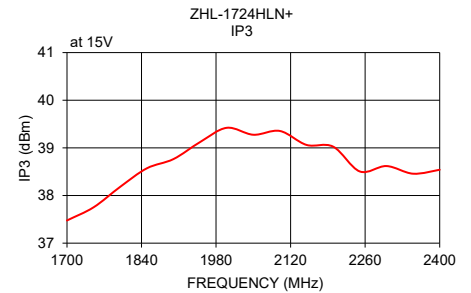
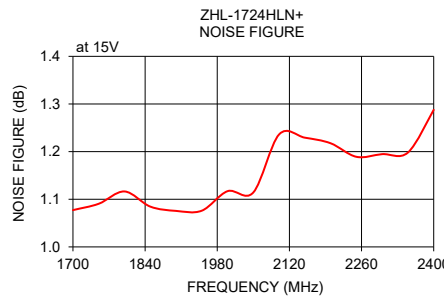
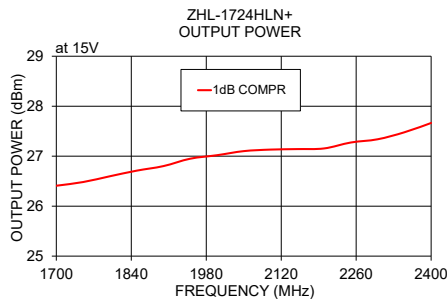
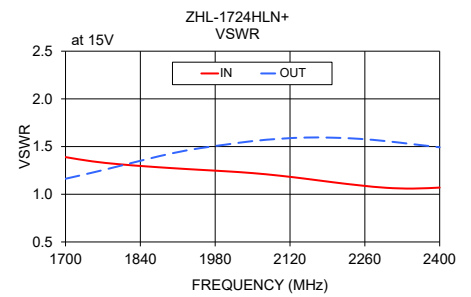
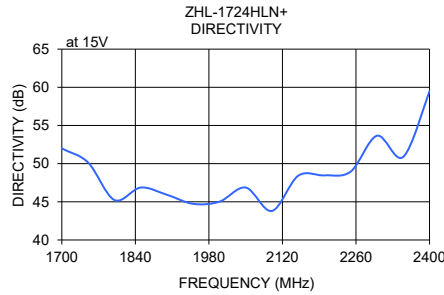
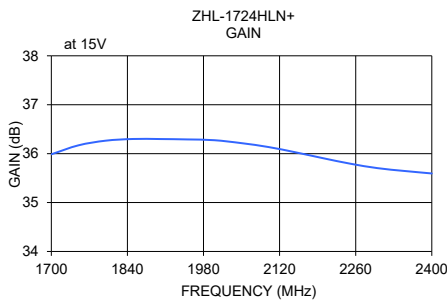

NOTES

- A. Performance and quality attributes and conditions not expressly stated in this specification document are intended to be excluded and do not form a part of this specification document.
- B. Electrical specifications and performance data contained in this specification document are based on Mini-Circuit's applicable established test performance criteria and measurement instructions.
- C. The parts covered by this specification document are subject to Mini-Circuits standard limited warranty and terms and conditions (collectively, "Standard Terms"); Purchasers of this part are entitled to the rights and benefits contained therein. For a full statement of the standard terms and the exclusive rights and remedies thereunder, please visit Mini-Circuits' website at www.minicircuits.com/terms/viewterm.html



Low Noise Amplifier

ZHL-1724HLN+

Typical Performance Data

FREQ. (MHz)	GAIN (dB) 15V	DIRECTIVITY (dB) 15V	VSWR (:1)		NOISE FIGURE (dB) 15V	POUT @ 1 dB COMPRESSION (dBm) 15V	OUTPUT IP3 (dBm) 15V
			IN 15V	OUT 15V			
1500	34.60	51.78	1.80	1.05	1.08	25.85	36.17
1525	34.74	55.68	1.74	1.05	1.11	26.00	36.47
1550	34.97	57.94	1.66	1.05	1.12	26.10	36.54
1575	35.12	54.99	1.61	1.06	1.09	26.12	36.77
1600	35.36	54.43	1.54	1.07	1.07	26.23	36.91
1625	35.50	54.41	1.50	1.08	1.09	26.26	37.18
1650	35.71	52.13	1.45	1.11	1.09	26.29	37.27
1675	35.83	49.01	1.42	1.13	1.05	26.35	37.39
1700	35.99	51.99	1.39	1.16	1.08	26.41	37.48
1725	36.07	48.38	1.37	1.19	1.02	26.44	37.77
1750	36.17	50.14	1.35	1.23	1.09	26.48	37.75
1775	36.22	48.25	1.33	1.25	1.02	26.50	37.85
1800	36.26	45.24	1.32	1.29	1.12	26.60	38.18
1825	36.29	48.07	1.31	1.32	1.01	26.63	38.34
1850	36.30	46.87	1.29	1.36	1.08	26.71	38.57
1875	36.30	47.40	1.29	1.39	1.13	26.81	38.87
1900	36.30	45.92	1.27	1.43	1.08	26.80	38.76
1925	36.29	44.39	1.27	1.45	1.04	26.85	38.97
1950	36.29	44.73	1.26	1.48	1.08	26.95	39.12
1975	36.29	42.97	1.25	1.50	1.15	26.90	39.19
2000	36.27	45.02	1.24	1.52	1.12	27.02	39.42
2025	36.25	45.17	1.23	1.54	1.08	27.01	39.25
2050	36.21	46.87	1.22	1.56	1.11	27.10	39.28
2075	36.19	45.19	1.21	1.57	1.16	27.08	39.39
2100	36.13	43.80	1.20	1.58	1.24	27.13	39.35
2125	36.09	45.51	1.18	1.59	1.16	27.11	39.19
2150	36.03	48.41	1.16	1.59	1.23	27.14	39.06
2175	35.98	47.32	1.15	1.60	1.20	27.20	38.84
2200	35.91	48.46	1.13	1.59	1.22	27.16	39.03
2225	35.86	48.40	1.11	1.59	1.24	27.19	38.53
2250	35.79	48.96	1.09	1.58	1.19	27.27	38.50
2275	35.76	51.86	1.08	1.57	1.10	27.30	38.40
2300	35.70	53.65	1.07	1.56	1.19	27.34	38.62
2325	35.68	56.50	1.06	1.54	1.19	27.43	38.41
2350	35.65	50.89	1.06	1.52	1.20	27.48	38.46
2375	35.62	58.02	1.06	1.51	1.20	27.55	38.51
2400	35.59	59.49	1.07	1.49	1.29	27.66	38.54
2425	35.58	53.56	1.08	1.48	1.37	27.80	38.61
2450	35.58	52.25	1.09	1.47	1.33	27.86	38.59
2475	35.59	52.55	1.10	1.46	1.35	27.96	38.55
2500	35.58	53.57	1.11	1.46	1.37	27.94	38.68



P.O. Box 350166, Brooklyn, New York 11235-0003 (718) 934-4500 • Fax (718) 332-4661 For detailed performance specs & shopping online see Mini-Circuits web site
 The Design Engineers Search Engine Provides ACTUAL Data Instantly From MINI-CIRCUITS At: www.minicircuits.com

IF/RF MICROWAVE COMPONENTS

REV. OR
 ZHL-1724HLN+
 7/22/2015
 Page 1 of 1

Low Noise Amplifier

ZHL-1724HLN+

Typical Performance Curves

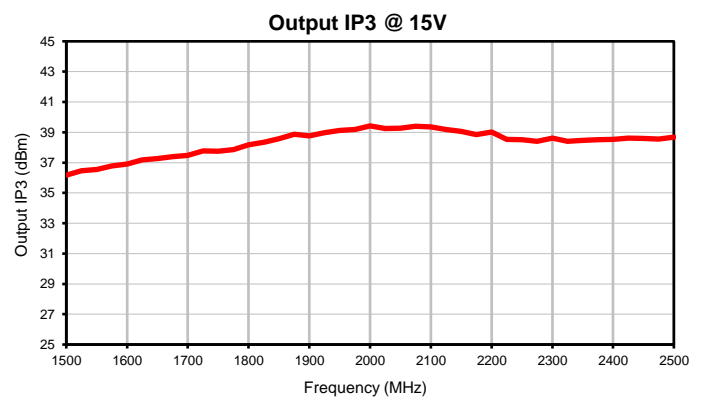
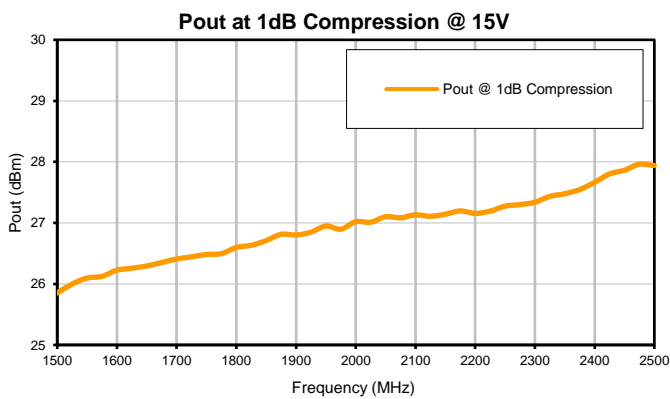
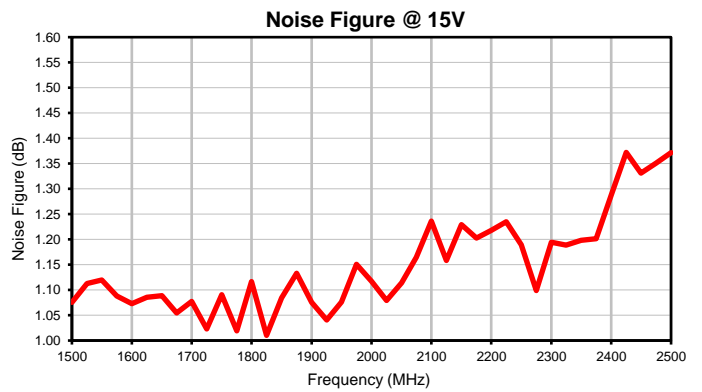
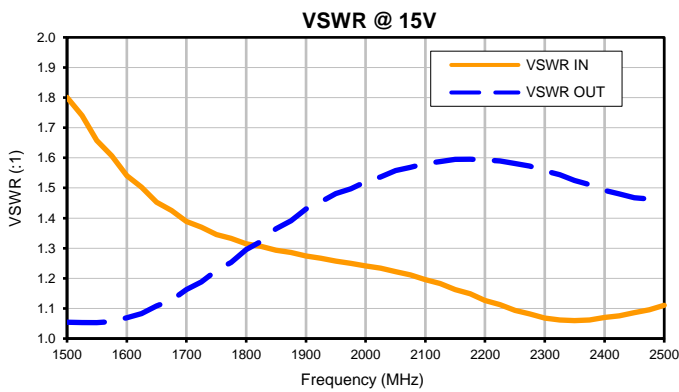
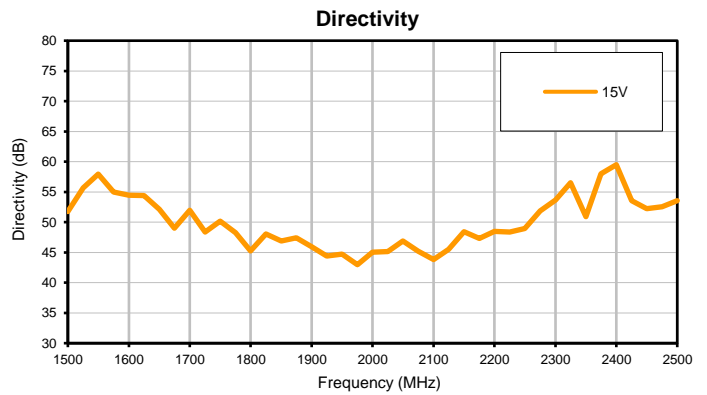
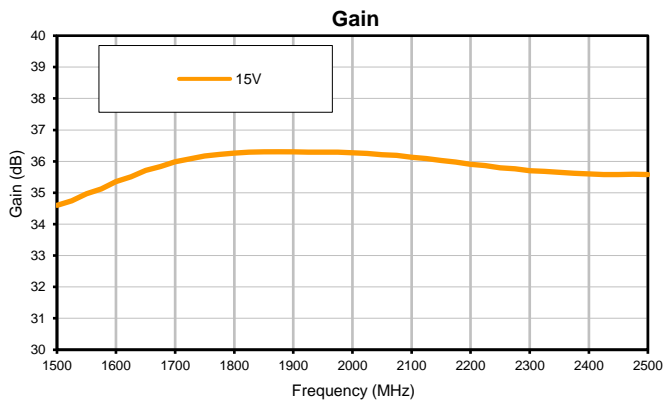

Outline Dimensions

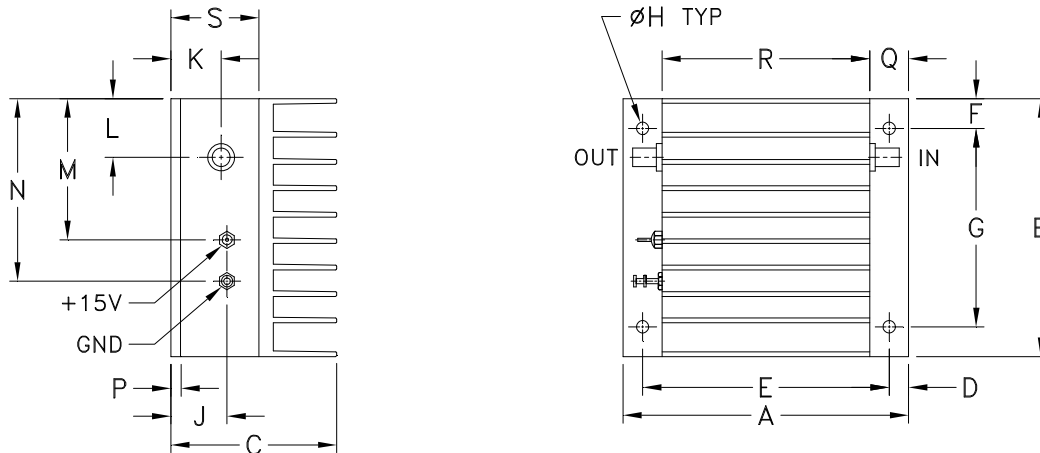

MOUNTING INFORMATION FOR MODELS WITHOUT HEATSINK

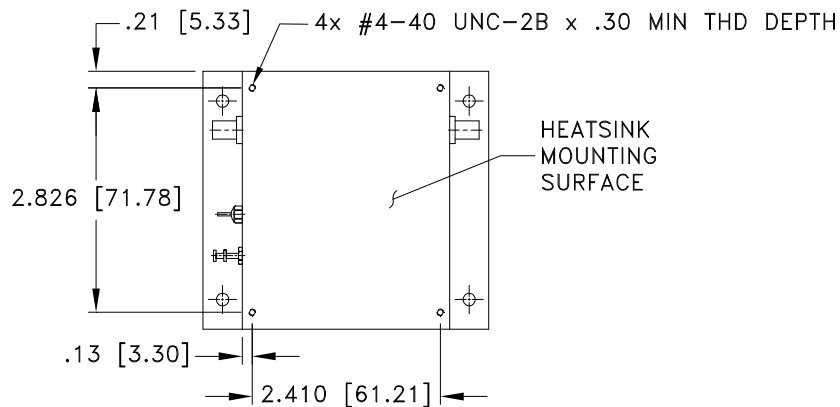

CASE#	A	B	C	D	E	F	G	H	J	K	L	M	N
NN92	3.66 (92.96)	3.25 (82.55)	2.13 (54.10)	.25 (6.35)	3.16 (80.26)	.38 (9.65)	2.50 (63.50)	.156 (3.96)	.72 (18.29)	.64 (16.26)	.74 (18.80)	1.78 (45.21)	2.30 (58.42)

CASE#	P	Q	R	S	WT. GRAMS	WT. WITHOUT HEATSINK GRAMS
NN92	.125 (3.18)	.50 (12.70)	2.66 (67.56)	1.13 (28.58)	500.0	362.0

Dimensions are in inches (mm). Tolerances: 2 Pl. + .03; 3 Pl. + .015

Notes:

- Case material: Aluminum alloy.
- Case and mounting bracket finish:
For RoHS Case Styles: Clear chemical conversion coating, non-chrome or trivalent chrome based.
- Heat sink finish: Black anodize.



INTERNET <http://www.minicircuits.com>

P.O. Box 350166, Brooklyn, New York 11235-0003 (718) 934-4500 Fax (718) 332-4661

Distribution Centers NORTH AMERICA 800-654-7949 • 417-335-5935 • Fax 417-335-5945 • EUROPE 44-1252-832600 • Fax 44-1252-837010

Mini-Circuits ISO 9001 & ISO 14001 Certified

All Mini-Circuits products are manufactured under exacting quality assurance and control standards, and are capable of meeting published specifications after being subjected to any or all of the following physical and environmental test.

Specification	Test/Inspection Condition	Reference/Spec
Operating Temperature	-54° to 65°C Ambient Environment	Individual Model Data Sheet
Storage Temperature	-55° to 100° C Ambient Environment	Individual Model Data Sheet
Stabilization Bake	(non-operating) 125°C, 24 hours	- - -
Burn-in at Elevated Temp.	(DC on) 160 hours at 85° C	MIL-STD-202, Method 108
Thermal Shock	-55° to 100°C, 5 cycles	MIL-STD-202, Method 107, Condition A, except 100°C