



COAXIAL

Medium Power Amplifier

ZHL-0G64G21W0+ ZHL-0G64G21W0X+

Mini-Circuits

50Ω 600 to 4200 MHz Broadband 1.6W SMA-Female

THE BIG DEAL

- Broadband, 600 to 4200MHz
- High Gain, 39dB typ.
- High P1dB, +32dBm, typ.
- High OIP3, +45dBm typ.



With heatsink

Without heatsink

Generic photo used for illustration purposes only

APPLICATIONS

- Communication Systems
- R&D, Production, and OTA Test Systems
- Test & Measurement Equipment
- General Laboratory Applications

FUNCTIONAL DIAGRAM

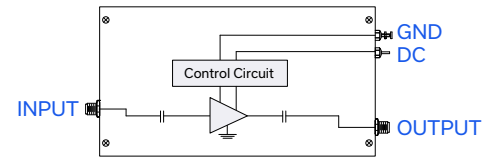

PRODUCT OVERVIEW

The ZHL-0G64G21W0(X)+ is a medium power broadband amplifier providing more than 1W of output power with a typical small signal gain of 39dB over the 600 to 4200 MHz frequency band. The amplifier uses state-of-the-art semiconductor technology and can be used in a wide range of applications. A single supply voltage ensures ease of operation. The amplifier is made with a rugged aluminum housing and can be supplied with or without a heatsink.

KEY FEATURES

Feature	Advantages
Extremely Broadband, 600 to 4200 MHz and High Power, 1.6W	One single amplifier that covers the entire frequency band delivering rated power.
High Gain, 39 dB Typ.	High gain allows low drive levels to achieve rated output power which can be obtained from many standard lab generators.
Rugged by design	Accidental reversing of the polarity of the power supply or accidental open/short (delivering P _{1dB} power) will not damage the amplifier.
High OIP3, +45 dBm Typ.	High OIP3 makes the amplifier suitable for applications requiring high linearity such as digitally modulated signals.
Rugged enclosure	The solid aluminum enclosure makes the amplifier usable for any application from industrial, to laboratory environments.





COAXIAL

Medium Power Amplifier

ZHL-0G64G21W0+
ZHL-0G64G21W0X+

Mini-Circuits

50Ω 600 to 4200 MHz Broadband 1.6W SMA-Female

ELECTRICAL SPECIFICATIONS AT $T_{MOUNTINGBASE} = +25^{\circ}C, V_{DC} = +28V$

Parameter	Symbol	Condition	Min.	Typ.	Max.	Units
Frequency Range	f		600		4200	MHz
Small Signal Gain	G_{SS}		38	39	43	dB
Small Signal Gain Flatness	$G_{SS-FLAT}$			± 0.8	± 1.1	dB
Output Power at 1 dB compression	P_{1dB}		+28	+32		dBm
Output Power at 3 dB compression	P_{3dB}		+29	+34		dBm
Noise Figure	NF			6.6		dB
Output Third Order Intercept Point	OIP3	$P_{OUT} = +20$ dBm/tone		+45		dBm
Input VSWR	I-VSWR			1.4	2.4	:1
Output VSWR	O-VSWR			1.6	2.4	:1
DC Supply Voltage	V_{DC}		+26	+28	+30	V
Supply Current	I_{DC}	@ P_{3dB}		0.83	1.00	A



COAXIAL

Medium Power Amplifier

ZHL-0G64G21W0+ ZHL-0G64G21W0X+

Mini-Circuits

50Ω 600 to 4200 MHz Broadband 1.6W SMA-Female

TYPICAL PERFORMANCE DATA AT $T_{MOUNTINGBASE} = 25^{\circ}C, 50\ OHM$

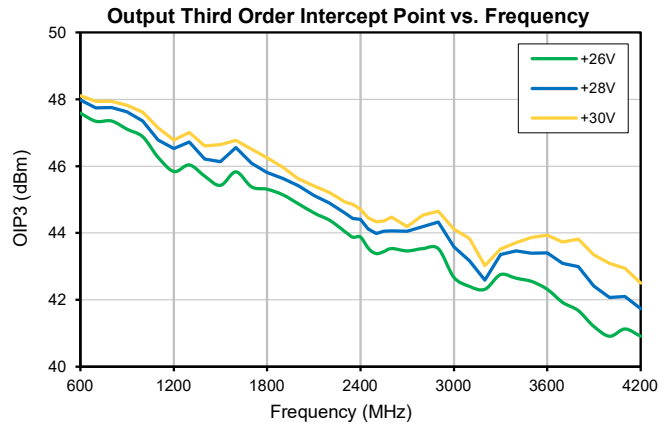
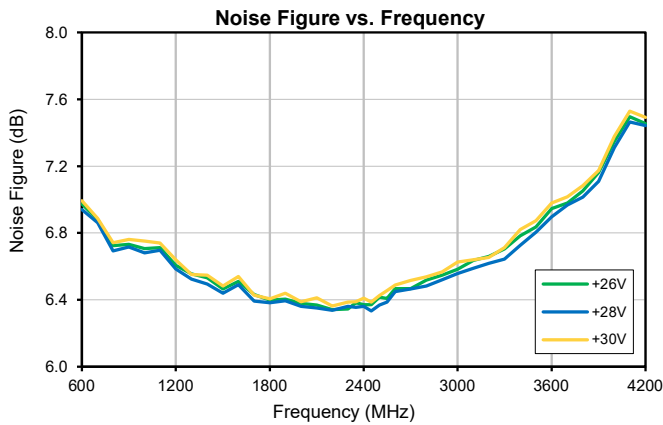
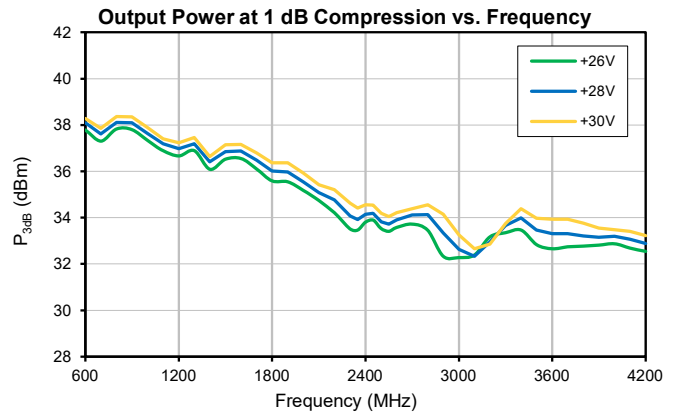
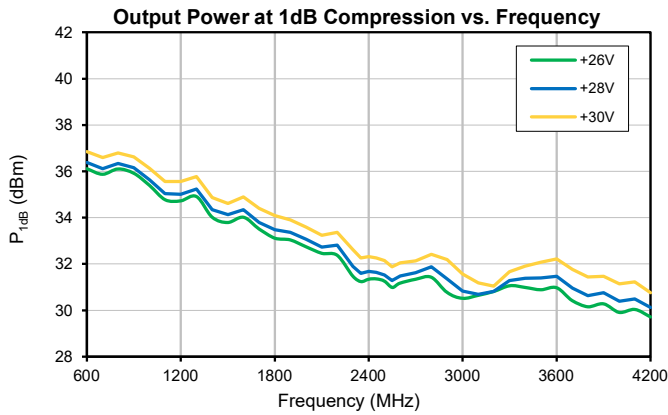
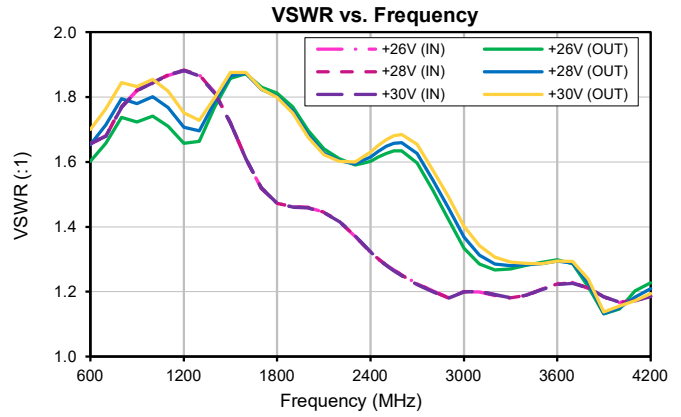
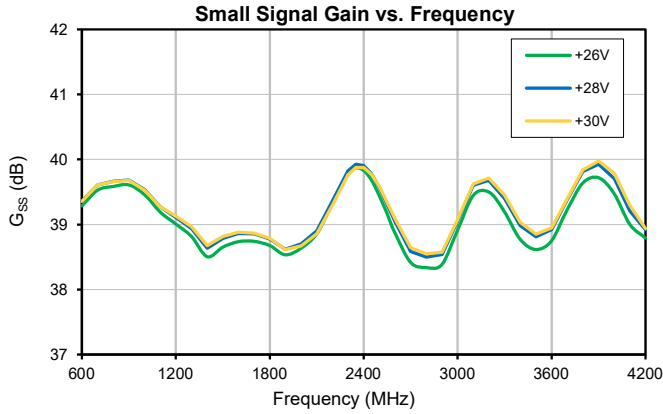



COAXIAL

Medium Power Amplifier

ZHL-0G64G21W0+
ZHL-0G64G21W0X+

Mini-Circuits

50Ω 600 to 4200 MHz Broadband 1.6W SMA-Female

ABSOLUTE MAXIMUM RATINGS

Parameter	Ratings	
Operating Temperature	ZHL-0G64G21W0+	T _{AMBIENT} : -20 °C to +65 °C
	ZHL-0G64G21W0X+	T _{MOUNTINGBASE} : -20 °C to +85 °C
Storage Temperature	-55 °C to +100 °C	
No damage with an open or short at P _{OUT} = +30 dBm CW for 2 minutes max		
RF Input Power (no damage)	+5 dBm	
DC Operating Voltage	± 30 V	

Permanent damage may occur if any of these limits are exceeded.

DETERMINING MAXIMUM THERMAL RESISTANCE OF USERS' EXTERNAL HEAT SINK

<i>MAXIMUM THERMAL RESISTANCE</i>	= $\frac{\text{MAXIMUM OPERATING CASE TEMP} - \text{MAXIMUM USER AMBIENT TEMP}}{\text{POWER DISSIPATION}}$
Example:	MAXIMUM MOUNTING BASE TEMP = +85 °C (CHECK MAXIMUM RATINGS TABLE FOR THIS VALUE) MAXIMUM USER AMBIENT TEMP = +65 °C (USER DEFINED) POWER DISSIPATION = 30 WATTS (CHECK MAXIMUM RATINGS TABLE FOR THIS VALUE) THEN MAXIMUM ALLOWABLE THERMAL RESISTANCE = 0.66 °C/W



COAXIAL

Medium Power Amplifier

ZHL-0G64G21W0+ ZHL-0G64G21W0X+

Mini-Circuits

50Ω 600 to 4200 MHz Broadband 1.6W SMA-Female

COAXIAL CONNECTIONS

IN (RF IN)	SMA-Female
OUT (RF OUT)	SMA-Female

CASE STYLE DRAWING WITH HEATSINK (ZHL-0G64G21W0+)

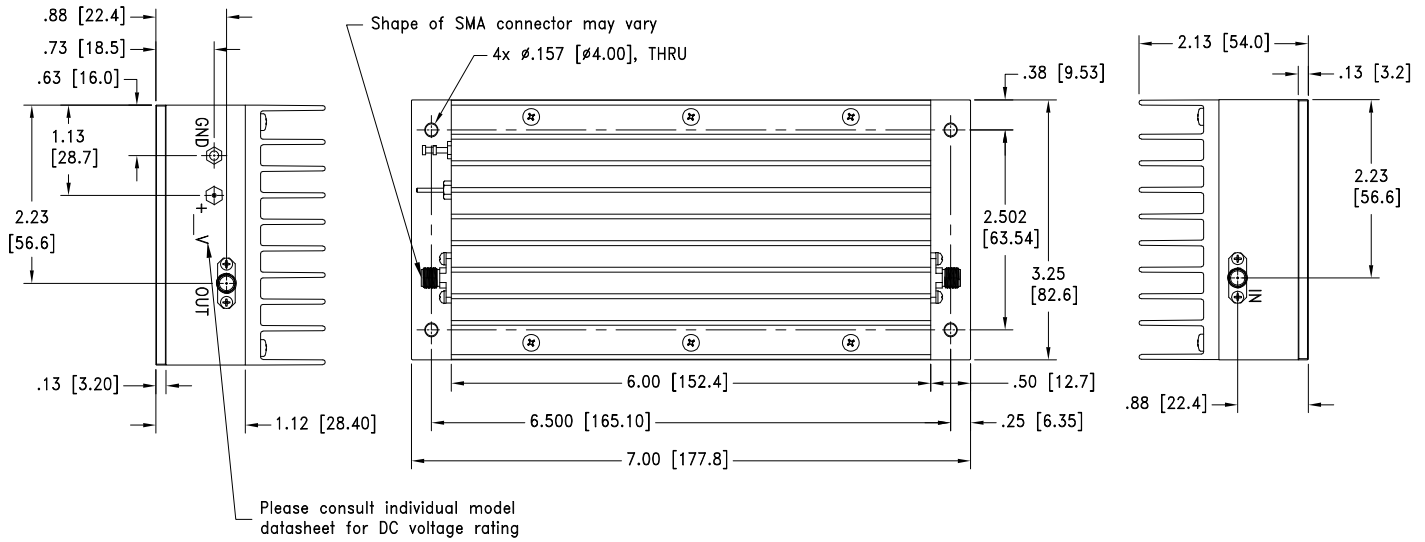

CASE STYLE DRAWING WITHOUT HEATSINK (ZHL-0G64G21W0X+)

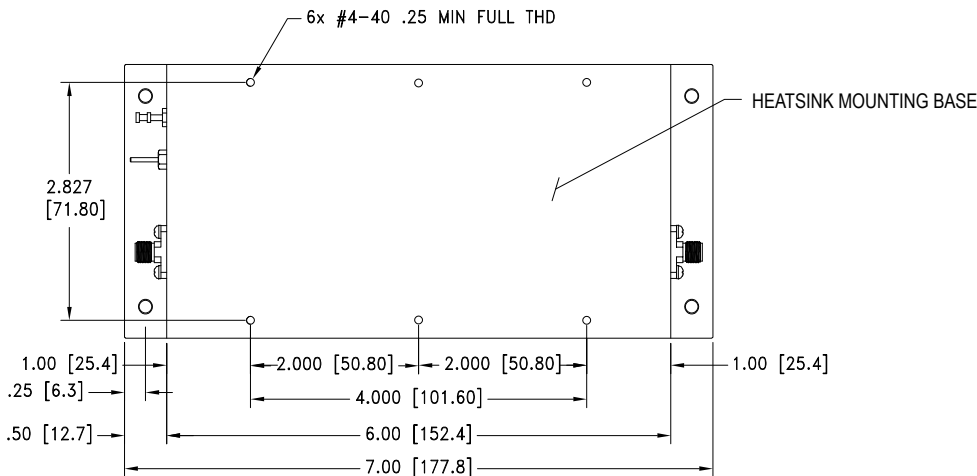

Weight: 900.0 grams. Weight without heatsink: 600.0 grams
 Dimensions are in inches [mm]. Tolerances: 2 Pl. \pm .03; 3 Pl. \pm .015 Inch





COAXIAL

Medium Power Amplifier

ZHL-0G64G21W0+
ZHL-0G64G21W10+

50Ω 600 to 4200 MHz Broadband 1.6W SMA-Female

ADDITIONAL INFORMATION IS AVAILABLE ON OUR DASHBOARD.

Performance Data	Table
	Graphs
	S-Parameter (S2P Files) Data Set (.zip file)
RoHS Status	Compliant
Environmental Ratings	ENV23T3

ORDERING INFORMATION

Model No. Links	ZHL-0G64G21W0+	ZHL-0G64G21W0X+
Option	With heatsink	Without heatsink
Case Style	U36	
Connector	IN (SMA-Female) / OUT (SMA-Female)	

NOTES

- A. Performance and quality attributes and conditions not expressly stated in this specification document are intended to be excluded and do not form a part of this specification document.
- B. Electrical specifications and performance data contained in this specification document are based on Mini-Circuit's applicable established test performance criteria and measurement instructions.
- C. The parts covered by this specification document are subject to Mini-Circuits standard limited warranty and terms and conditions (collectively, "Standard Terms"); Purchasers of this part are entitled to the rights and benefits contained therein. For a full statement of the standard terms and the exclusive rights and remedies thereunder, please visit Mini-Circuits' website at www.minicircuits.com/terms/viewterm.html



Typical Performance Data

Frequency (MHz)	Small Signal Gain (dB)			Isolation (dB)			VSWR (:1)					
							In			Out		
	26V	28V	30V	26V	28V	30V	26V	28V	30V	26V	28V	30V
600	39.29	39.36	39.36	92.08	92.11	98.05	1.66	1.66	1.66	1.60	1.65	1.70
700	39.53	39.61	39.61	94.92	97.30	92.89	1.68	1.68	1.68	1.66	1.71	1.76
800	39.59	39.67	39.66	91.58	94.39	90.95	1.77	1.77	1.77	1.74	1.80	1.84
900	39.61	39.68	39.68	92.53	90.67	94.45	1.82	1.82	1.82	1.72	1.78	1.83
1000	39.46	39.54	39.53	89.94	92.80	91.21	1.84	1.84	1.84	1.74	1.80	1.85
1100	39.19	39.28	39.28	90.32	88.89	93.59	1.87	1.87	1.87	1.71	1.77	1.82
1200	39.01	39.11	39.13	88.98	90.56	91.73	1.88	1.88	1.88	1.66	1.71	1.75
1300	38.82	38.94	38.97	91.92	89.13	90.43	1.87	1.87	1.87	1.66	1.70	1.73
1400	38.51	38.64	38.68	89.58	88.20	93.94	1.81	1.81	1.81	1.77	1.78	1.80
1500	38.65	38.79	38.82	89.16	89.84	89.85	1.72	1.72	1.72	1.86	1.87	1.88
1600	38.74	38.86	38.88	86.73	89.67	88.00	1.61	1.61	1.61	1.87	1.87	1.88
1700	38.74	38.86	38.87	85.46	88.41	88.22	1.52	1.52	1.52	1.83	1.82	1.82
1800	38.68	38.78	38.79	87.15	89.12	89.56	1.47	1.47	1.47	1.81	1.80	1.80
1900	38.54	38.62	38.62	86.83	89.11	87.56	1.46	1.46	1.46	1.77	1.76	1.75
2000	38.64	38.70	38.67	85.71	87.45	86.91	1.46	1.46	1.46	1.70	1.68	1.68
2100	38.86	38.90	38.86	86.78	86.06	85.97	1.44	1.44	1.44	1.64	1.63	1.62
2200	39.33	39.36	39.29	85.27	86.17	86.08	1.42	1.42	1.42	1.61	1.60	1.60
2300	39.79	39.83	39.77	83.08	84.87	84.06	1.37	1.37	1.37	1.59	1.59	1.60
2350	39.87	39.93	39.88	86.72	84.87	84.99	1.34	1.35	1.35	1.60	1.60	1.61
2400	39.83	39.91	39.88	83.05	84.77	84.35	1.32	1.32	1.32	1.60	1.61	1.63
2450	39.68	39.79	39.78	83.04	84.27	84.81	1.30	1.30	1.30	1.61	1.63	1.65
2500	39.44	39.57	39.58	83.81	83.51	86.65	1.28	1.28	1.28	1.63	1.65	1.67
2550	39.16	39.31	39.34	84.52	84.69	85.41	1.27	1.27	1.26	1.63	1.66	1.68
2600	38.87	39.04	39.09	83.66	83.67	86.74	1.25	1.25	1.25	1.63	1.66	1.69
2700	38.42	38.59	38.65	84.00	84.76	86.09	1.22	1.22	1.22	1.60	1.63	1.65
2800	38.34	38.50	38.55	83.85	84.95	85.08	1.20	1.20	1.20	1.51	1.54	1.57
2900	38.39	38.54	38.57	83.35	84.31	85.97	1.18	1.18	1.18	1.42	1.46	1.49
3000	38.91	39.05	39.07	83.40	84.44	85.11	1.20	1.20	1.20	1.33	1.37	1.40
3100	39.45	39.60	39.62	83.78	83.68	84.62	1.20	1.20	1.20	1.29	1.31	1.34
3200	39.50	39.68	39.72	82.00	84.45	84.56	1.19	1.19	1.19	1.27	1.29	1.31
3300	39.19	39.40	39.45	83.36	83.84	84.24	1.18	1.18	1.18	1.27	1.28	1.29
3400	38.77	38.98	39.04	84.74	84.77	84.84	1.19	1.19	1.19	1.28	1.28	1.29
3500	38.62	38.81	38.85	83.44	86.15	85.32	1.21	1.21	1.21	1.29	1.29	1.29
3600	38.75	38.92	38.95	84.79	85.07	85.56	1.23	1.22	1.22	1.30	1.29	1.29
3700	39.22	39.39	39.40	84.12	84.11	85.22	1.23	1.23	1.23	1.29	1.29	1.29
3800	39.64	39.81	39.84	83.85	85.14	85.54	1.21	1.21	1.21	1.21	1.23	1.24
3900	39.72	39.93	39.98	84.14	85.72	86.11	1.18	1.18	1.18	1.13	1.13	1.14
4000	39.48	39.70	39.79	85.42	84.36	86.23	1.17	1.17	1.17	1.15	1.15	1.16
4100	39.00	39.21	39.30	84.09	85.05	88.10	1.17	1.17	1.17	1.20	1.18	1.17
4200	38.79	38.92	38.94	84.06	84.33	86.53	1.19	1.19	1.18	1.23	1.21	1.19

Typical Performance Curves

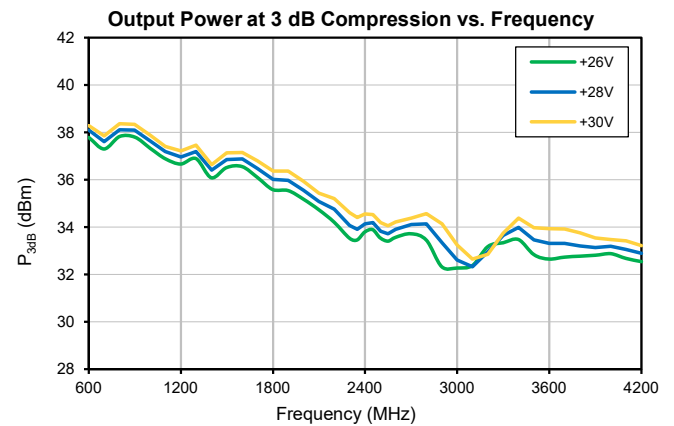
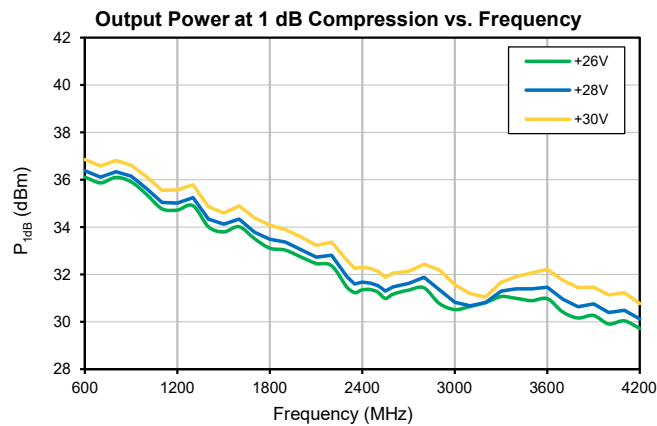
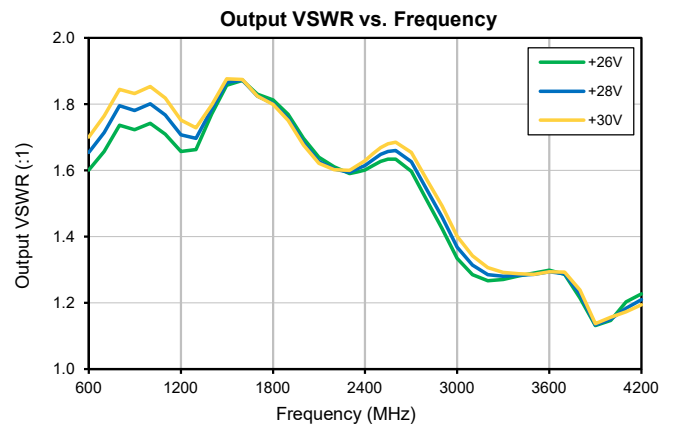
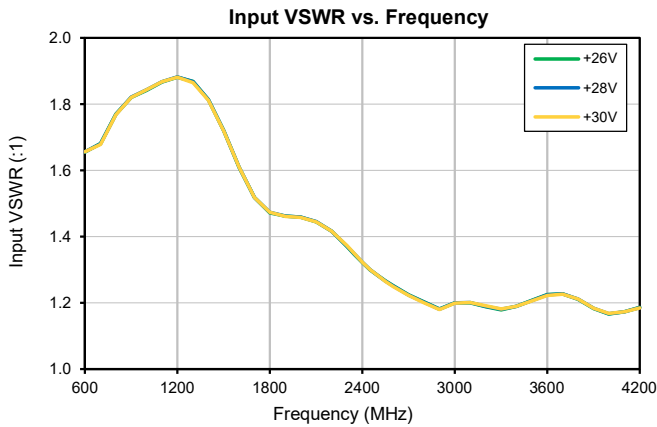
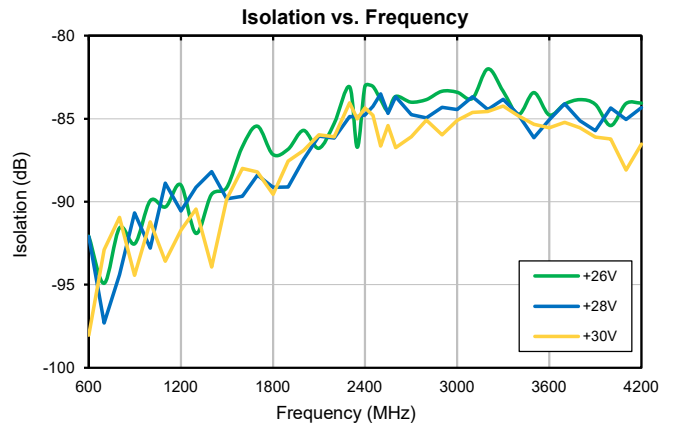
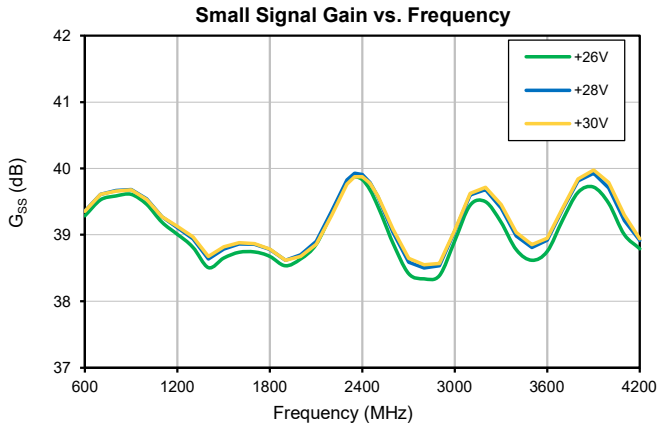

Typical Performance Curves

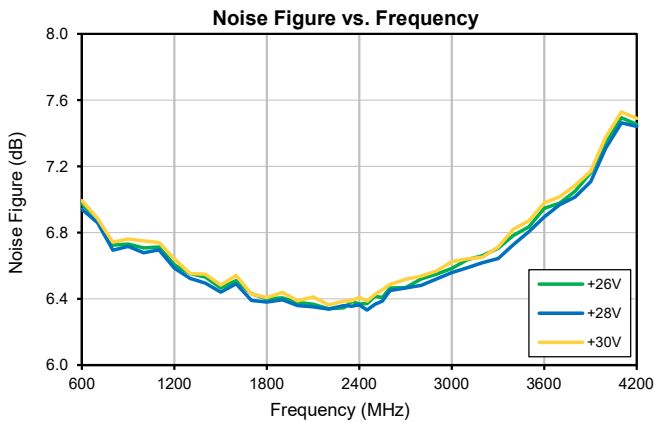
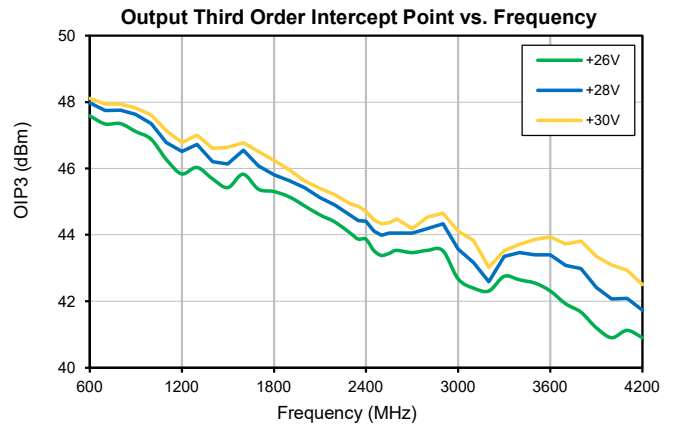
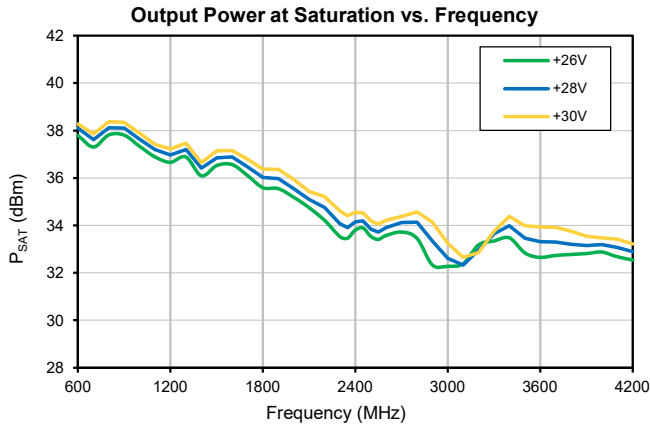

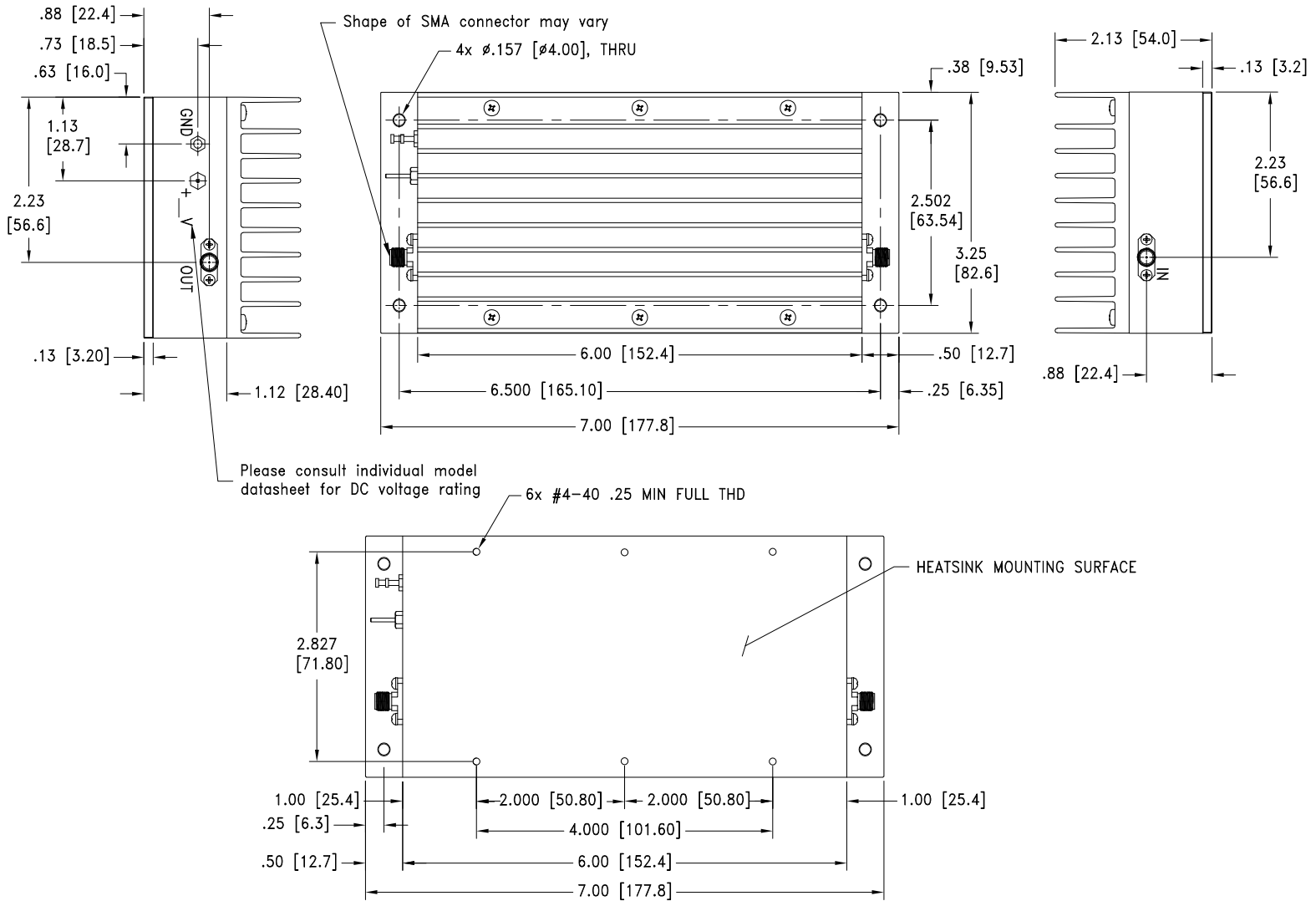

MOUNTING INFORMATION FOR MODELS WITHOUT HEATSINK

Weight: 900.0 grams Weight without heatsink: 600.0 grams

Dimensions are in inches [mm]. Tolerances: 2 Pl. \pm 03; ; 3 Pl. \pm .015 Inch

Notes:

- Case material: Aluminum alloy.
- Case finish and mounting bracket finish:
For RoHS Case Styles: Clear chemical conversion coating, non-chrome or trivalent chrome based.

For Non-RoHS Case Styles: Yellow hexavalent chrome based conversion coating.
Due to transition from non-RoHS to RoHS, models will be supplied with either case style finish until the non-RoHS case inventory is depleted.

- Heat sink finish: Black anodize.



P.O. Box 350166, Brooklyn, New York 11235-0003 (718) 934-4500 Fax (718) 332-4661 For detailed performance specs & shopping online see Mini-Circuits web site



The Design Engineers Search Engine Provides ACTUAL Data Instantly From MINI-CIRCUITS At: www.minicircuits.com

RF/IF MICROWAVE COMPONENTS

All Mini-Circuits products are manufactured under exacting quality assurance and control standards, and are capable of meeting published specifications after being subjected to any or all of the following physical and environmental test.

Specification	Test/Inspection Condition	Reference/Spec
Operating Temperature	-20° to 65° C Ambient Environment	Individual Model Data Sheet
Storage Temperature	-55° to 100° C Ambient Environment	Individual Model Data Sheet
Stabilization Bake	(non-operating) 125°C, 24 hours	- - -
Burn-in at Elevated Temp.	(DC on) 160 hours at 85° C	MIL-STD-202, Method 108
Thermal Shock	-55° to 100°C, 5 cycles	MIL-STD-202, Method 107, Condition A, except 100°C