



COAXIAL

Low Noise Amplifier

ZHL-0812HLN+ ZHL-0812HLNX+

50Ω 800 to 1200 MHz

FEATURES

- Very Low Noise Figure, 1.5 dB max.
- Wideband, 800 to 1200 MHz
- High Dynamic Range

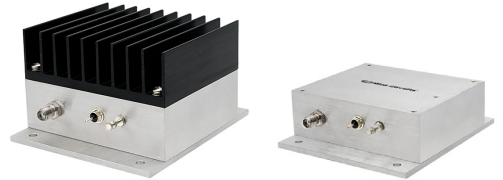

Generic photo used for illustration purposes only

Model No.	ZHL-0812HLN+	ZHL-0812HLNX+ ▲
Case Style	NN92	
Connectors	SMA	

+RoHS Compliant

The +Suffix identifies RoHS Compliance.
See our website for methodologies and qualifications

APPLICATIONS

- UHF
- Cellular
- Communication Systems

ELECTRICAL SPECIFICATIONS AT 25°C

Parameter	Frequency (MHz)	ZHL-0812HLN+			ZHL-0812HLNX+▲			Units
		Min.	Typ.	Max.	Min	Typ.	Max.	
Frequency Range		800		1200	800		1200	MHz
Noise Figure ¹	800-1200	—	0.5	1.5	—	0.5	1.5	dB
Gain	800-1200	38	—	—	30	—	—	dB
Gain Flatness	800-1200	—	—	±1.0	—	—	±1.0	dB
Output Power at 1dB compression	800-1200	—	+26	—	—	+26	—	dBm
Output third order intercept point	800-1200	—	+36	—	—	+36	—	dBm
Input VSWR	800-1200	—	1.4	—	—	1.4	—	:1
Output VSWR	800-1200	—	1.3	—	—	1.3	—	:1
DC Supply Voltage		—	15	—	—	15	—	V
Supply Current		—	620	725	—	620	725	mA

1. Noise Figure specified at room temperature, increases to 2.3 dB max. at +65°C
Open load is not recommended, potentially can cause damage.
With no load derate max input power by 20 dB

▲ Heat sink not included. Alternative heat sinking and heat removal must be provided by the user to limit maximum base-plate temperature to 65°C, in order to ensure proper performance. For reference, this requires thermal resistance of user's external heat sink to be 1.8°C/W max.

ABSOLUTE MAXIMUM RATINGS

Parameter	Ratings
Operating Temperature	-20°C to +65°C
Storage Temperature	-55°C to +100°C
DC Voltage	+20V
Input RF Power (no damage)	+10 dBm

Permanent damage may occur if any of these limits are exceeded.





COAXIAL

Low Noise Amplifier

ZHL-0812HLN+ ZHL-0812HLNX+

Mini-Circuits

50Ω 800 to 1200 MHz

OUTLINE DRAWING

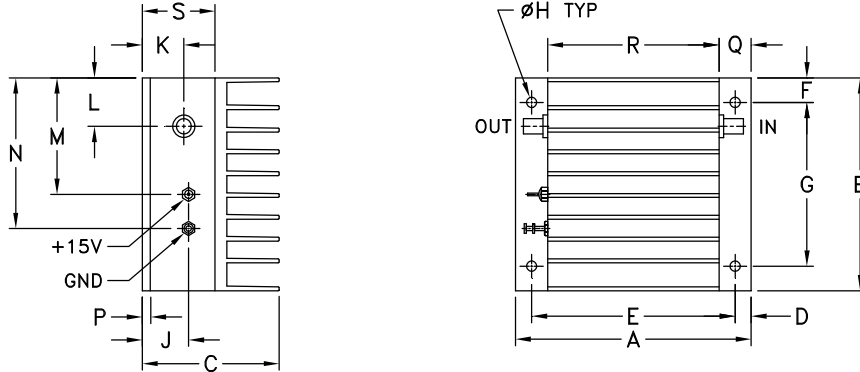

MOUNTING INFORMATION FOR MODELS WITHOUT HEATSINK

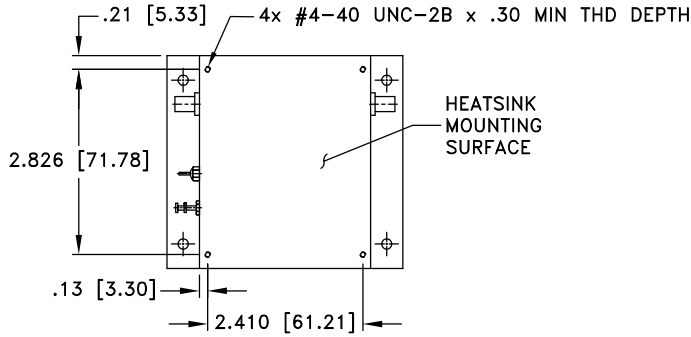

OUTLINE DIMENSIONS (Inch/mm)

A	B	C	D	E	F	G	H	J	K	L	M	N	P	Q	R	S	wt
3.66	3.25	2.13	.25	3.16	.38	2.50	.156	.72	.64	.74	1.78	2.30	.125	.50	2.66	1.13	grams*
92.96	82.55	54.10	6.35	80.26	9.65	63.50	3.96	18.29	16.26	18.80	45.21	58.42	3.18	12.70	67.56	28.7	500.0

*362 grams without heatsink





COAXIAL

Low Noise Amplifier

ZHL-0812HLN+ ZHL-0812HLNX+

50Ω 800 to 1200 MHz

TYPICAL PERFORMANCE DATA/CURVES

FREQUENCY (MHz)	GAIN (dB)	DIRECTIVITY (dB)	VSWR (:1)		POUT at 1 dB COMPR. (dBm)	NOISE FIGURE (dB)	IP3 (dBm)
	15V	15V	IN	OUT	15V	15V	15V
800	44.97	47.60	1.22	1.32	26.98	0.52	38.65
820	45.09	50.34	1.16	1.36	26.84	0.47	38.77
840	45.17	45.89	1.12	1.39	26.83	0.49	38.77
860	45.21	43.36	1.12	1.41	26.75	0.41	38.75
880	45.24	45.75	1.15	1.43	26.76	0.45	38.61
900	45.27	45.86	1.18	1.44	26.88	0.35	38.66
920	45.31	47.45	1.22	1.44	26.88	0.45	38.71
940	45.36	45.75	1.26	1.44	26.96	0.38	38.76
960	45.42	43.40	1.29	1.43	26.83	0.46	38.56
980	45.50	44.39	1.32	1.40	26.72	0.42	38.55
1000	45.57	43.90	1.35	1.37	26.81	0.46	38.62
1050	45.73	44.40	1.38	1.27	26.79	0.31	38.36
1100	45.80	42.68	1.39	1.16	26.75	0.35	38.13
1150	45.70	37.41	1.36	1.07	26.77	0.42	37.48
1200	44.48	42.14	1.33	1.13	26.59	0.49	37.49

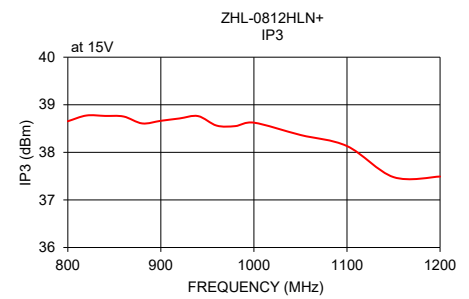
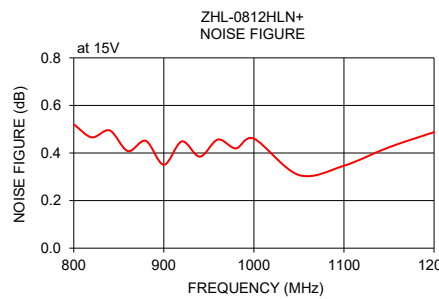
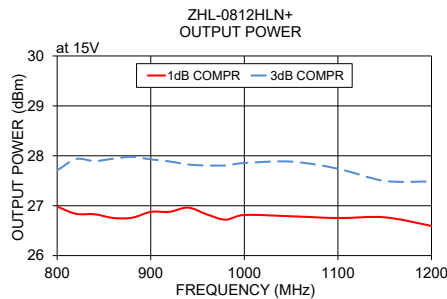
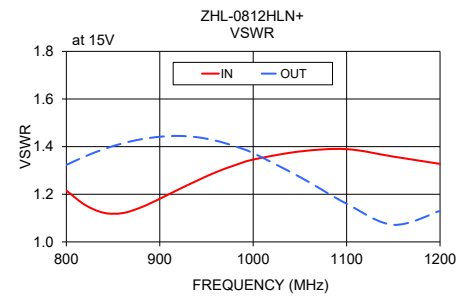
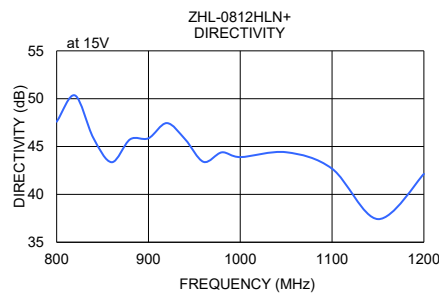
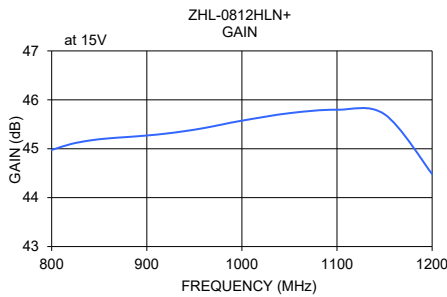

- NOTES**
- A. Performance and quality attributes and conditions not expressly stated in this specification document are intended to be excluded and do not form a part of this specification document.
 - B. Electrical specifications and performance data contained in this specification document are based on Mini-Circuit's applicable established test performance criteria and measurement instructions.
 - C. The parts covered by this specification document are subject to Mini-Circuits standard limited warranty and terms and conditions (collectively, "Standard Terms"); Purchasers of this part are entitled to the rights and benefits contained therein. For a full statement of the standard terms and the exclusive rights and remedies thereunder, please visit Mini-Circuits' website at www.minicircuits.com/terms/viewterm.html



Low Noise Amplifier

ZHL-0812HLN+

Typical Performance Data

FREQ. (MHz)	GAIN (dB) 15V	DIRECTIVITY (dB) 15V	VSWR (:1)		NOISE FIGURE (dB) 15V	POUT @ 1 dB COMPRESSION (dBm) 15V	POUT @ 3 dB COMPRESSION (dBm) 15V	OUTPUT IP3 (dBm) 15V
			IN 15V	OUT 15V				
800	44.97	47.60	1.22	1.32	0.52	26.98	27.71	38.65
810	45.04	46.22	1.18	1.34	0.50	26.83	27.69	38.73
820	45.09	50.34	1.16	1.36	0.47	26.84	27.93	38.77
840	45.17	45.89	1.12	1.39	0.49	26.83	27.89	38.77
850	45.19	49.32	1.12	1.40	0.51	26.88	27.75	38.67
860	45.21	43.36	1.12	1.41	0.41	26.75	27.94	38.75
870	45.22	45.37	1.13	1.42	0.44	26.63	27.84	38.73
880	45.24	45.75	1.15	1.43	0.45	26.76	27.98	38.61
890	45.26	47.98	1.16	1.44	0.36	26.77	27.88	38.66
900	45.27	45.86	1.18	1.44	0.35	26.88	27.93	38.66
910	45.29	46.84	1.20	1.44	0.42	26.89	27.98	38.69
920	45.31	47.45	1.22	1.44	0.45	26.88	27.89	38.71
930	45.34	44.87	1.24	1.44	0.45	26.84	27.85	38.63
940	45.36	45.75	1.26	1.44	0.38	26.96	27.83	38.76
950	45.39	45.30	1.28	1.43	0.36	26.86	27.87	38.63
960	45.42	43.40	1.29	1.43	0.46	26.83	27.81	38.56
970	45.46	49.12	1.31	1.41	0.37	26.96	27.87	38.64
980	45.50	44.39	1.32	1.40	0.42	26.72	27.81	38.55
990	45.54	42.03	1.33	1.39	0.36	26.99	27.79	38.64
1000	45.57	43.90	1.35	1.37	0.46	26.81	27.85	38.62
1010	45.61	43.26	1.36	1.36	0.40	26.78	27.73	38.48
1020	45.65	43.99	1.36	1.34	0.33	26.93	27.68	38.47
1030	45.68	42.00	1.37	1.32	0.32	26.93	27.70	38.44
1040	45.70	43.84	1.38	1.30	0.39	26.90	27.93	38.43
1050	45.73	44.40	1.38	1.27	0.31	26.79	27.88	38.36
1060	45.74	43.28	1.38	1.25	0.34	27.04	27.93	38.34
1070	45.76	45.84	1.39	1.23	0.38	26.89	27.79	38.27
1080	45.77	46.56	1.39	1.20	0.39	26.91	27.92	38.35
1090	45.78	51.77	1.39	1.18	0.34	26.91	27.58	38.11
1100	45.80	42.68	1.39	1.16	0.35	26.75	27.74	38.13
1110	45.82	47.52	1.39	1.14	0.36	26.94	27.67	38.04
1120	45.84	43.45	1.39	1.13	0.43	26.74	27.63	37.91
1130	45.85	44.49	1.38	1.11	0.45	26.76	27.53	37.78
1140	45.82	41.91	1.37	1.10	0.41	26.90	27.73	37.66
1150	45.70	37.41	1.36	1.07	0.42	26.77	27.50	37.48
1160	45.50	37.94	1.34	1.04	0.40	26.58	27.67	37.44
1170	45.25	39.54	1.33	1.03	0.45	26.58	27.53	37.53
1180	44.98	40.82	1.32	1.05	0.49	26.49	27.62	37.54
1190	44.72	39.74	1.32	1.09	0.49	26.52	27.65	37.49
1200	44.48	42.14	1.33	1.13	0.49	26.59	27.49	37.49



P.O. Box 350166, Brooklyn, New York 11235-0003 (718) 934-4500 • Fax (718) 332-4661 For detailed performance specs & shopping online see Mini-Circuits web site



The Design Engineers Search Engine Provides ACTUAL Data Instantly From MINI-CIRCUITS At: www.minicircuits.com

IF/RF MICROWAVE COMPONENTS

REV. OR
ZHL-0812HLN+
8/7/2015
Page 1 of 1

Typical Performance Curves

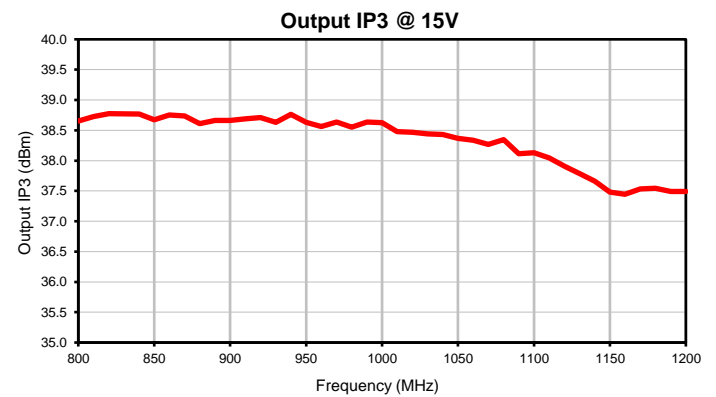
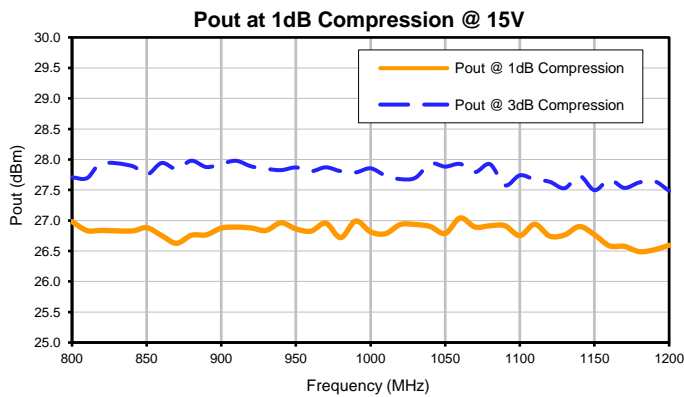
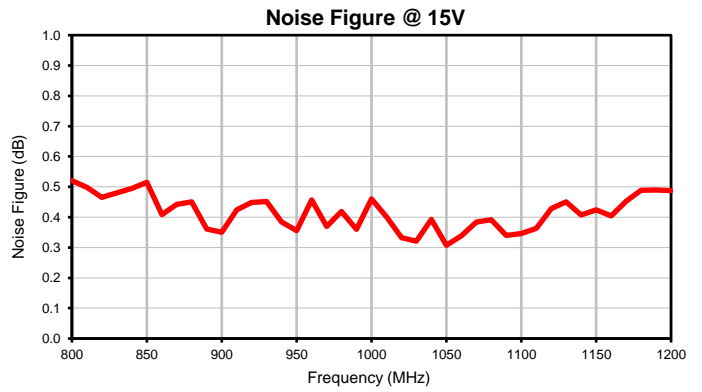
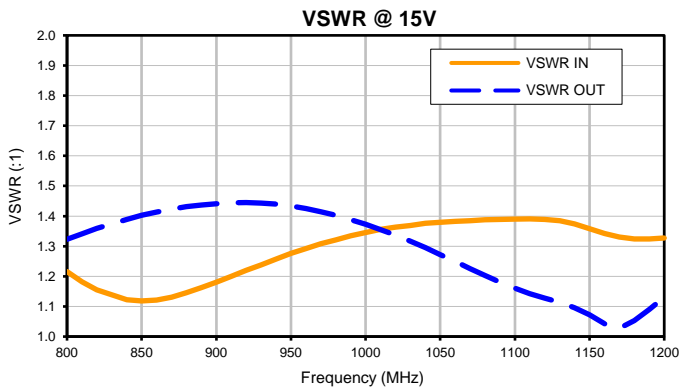
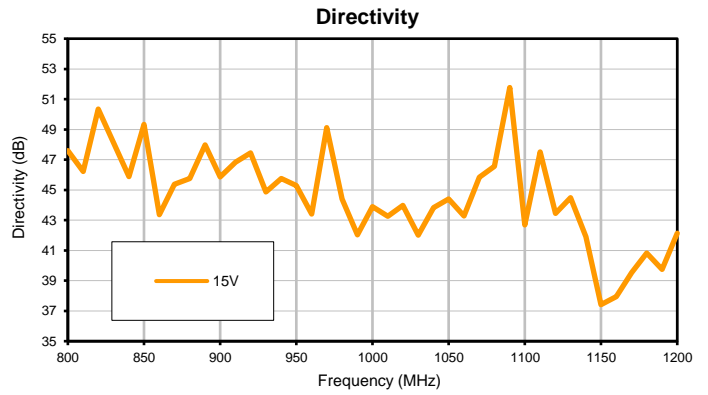
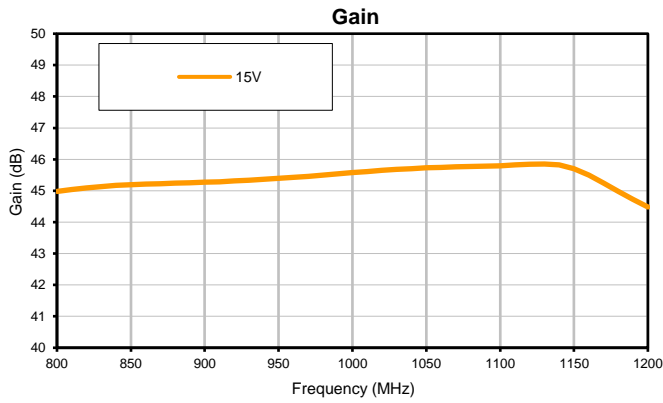

Outline Dimensions

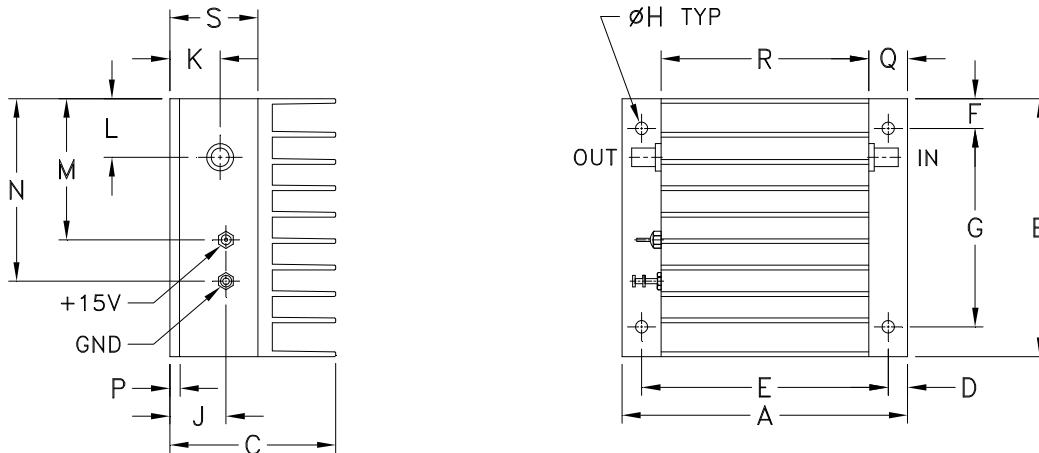

MOUNTING INFORMATION FOR MODELS WITHOUT HEATSINK

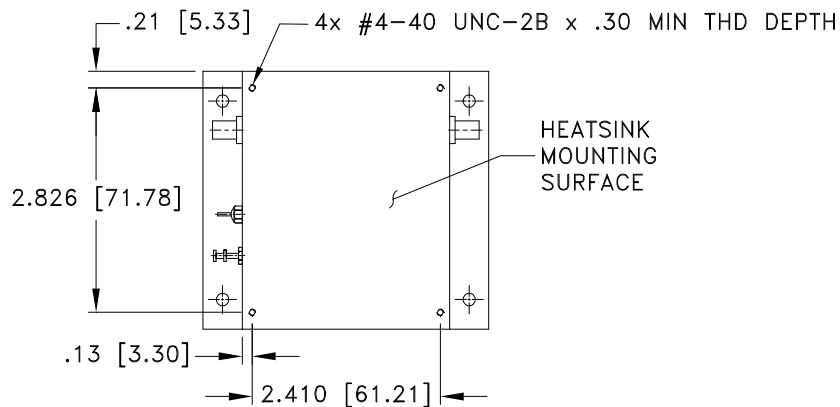

CASE#	A	B	C	D	E	F	G	H	J	K	L	M	N
NN92	3.66 (92.96)	3.25 (82.55)	2.13 (54.10)	.25 (6.35)	3.16 (80.26)	.38 (9.65)	2.50 (63.50)	.156 (3.96)	.72 (18.29)	.64 (16.26)	.74 (18.80)	1.78 (45.21)	2.30 (58.42)

CASE#	P	Q	R	S	WT. GRAMS	WT. WITHOUT HEATSINK GRAMS
NN92	.125 (3.18)	.50 (12.70)	2.66 (67.56)	1.13 (28.58)	500.0	362.0

Dimensions are in inches (mm). Tolerances: 2 Pl. + .03; 3 Pl. + .015

Notes:

- Case material: Aluminum alloy.
- Case and mounting bracket finish:
For RoHS Case Styles: Clear chemical conversion coating, non-chrome or trivalent chrome based.
- Heat sink finish: Black anodize.



INTERNET <http://www.minicircuits.com>

P.O. Box 350166, Brooklyn, New York 11235-0003 (718) 934-4500 Fax (718) 332-4661

Distribution Centers NORTH AMERICA 800-654-7949 • 417-335-5935 • Fax 417-335-5945 • EUROPE 44-1252-832600 • Fax 44-1252-837010

Mini-Circuits ISO 9001 & ISO 14001 Certified

All Mini-Circuits products are manufactured under exacting quality assurance and control standards, and are capable of meeting published specifications after being subjected to any or all of the following physical and environmental test.

Specification	Test/Inspection Condition	Reference/Spec
Operating Temperature	-54° to 65°C Ambient Environment	Individual Model Data Sheet
Storage Temperature	-55° to 100° C Ambient Environment	Individual Model Data Sheet
Stabilization Bake	(non-operating) 125°C, 24 hours	- - -
Burn-in at Elevated Temp.	(DC on) 160 hours at 85° C	MIL-STD-202, Method 108
Thermal Shock	-55° to 100°C, 5 cycles	MIL-STD-202, Method 107, Condition A, except 100°C