

Absorptive SPDT RF Switch

ZFSWA2-63DR+

50Ω 500-6000 MHz

The Big Deal

- Wide bandwidth 500 to 6000 MHz
- Very high isolation, 65 dB at 1GHz
- Very fast switching, 35ns
- Rugged case with internal hermetically sealed ceramic semi-conductor module



CASE STYLE: ZZ1322

Product Overview

The ZFSWA2-63DR+ is a great general purpose SPDT solid state absorptive RF switch. With its broad frequency range, fast 35 ns switching time and excellent RF performance, the ZFSWA2-63DR+ is an excellent choice for many applications. In addition to its versatility within system block diagrams, the ZFSWA2-63DR+ is designed for easy integration into your prototype design applications.

Note: This model is same as ZFSWA2R-63DR+ except RF1 and RF2 ports are interchanged.

Key Features

Feature	Advantages
Designed for any environment	The ZFSWA2-63DR+ is equipped with a rugged shielded case, a hermetically sealed internal device with a wide operating temperature range (-55°C to 100°C) Suitable for many environments and applications the ZFSWA2-63DR+ offers excellent performance and value
Integrated CMOS Driver	-Operates from 3-5V -Low control current 5 μA allows compatibility with a variety of driver circuits -Internal Decoupling -Fast 35 ns Switching time
Excellent for a Variety of Applications From Bench to Integrated Systems	-High speed testers -Automated switching networks -Wireless Infrastructure -Military
Excellent RF Performance	-Wide bandwidth: 500 to 6000 MHz -Low Insertion Loss: 1.4 dB Typ -High Isolation: 65 dB Typ @ 1 GHz

Notes

- A. Performance and quality attributes and conditions not expressly stated in this specification document are intended to be excluded and do not form a part of this specification document.
B. Electrical specifications and performance data contained in this specification document are based on Mini-Circuit's applicable established test performance criteria and measurement instructions.
C. The parts covered by this specification document are subject to Mini-Circuits standard limited warranty and terms and conditions (collectively, "Standard Terms"); Purchasers of this part are entitled to the rights and benefits contained therein. For a full statement of the Standard Terms and the exclusive rights and remedies thereunder, please visit Mini-Circuits' website at www.minicircuits.com/MCLStore/terms.jsp



Coaxial

SPDT RF Switch

50Ω 500-6000 MHz

Absorptive RF Switch with Internal Driver
Single Supply Voltage, +3V to +5V

Product Features

- Wide bandwidth, 500 to 6000 MHz
- High Isolation, 65 dB typ. at 1 GHz
- Low Insertion loss, 1.4 dB typ.
- Internal CMOS driver
- Fast switching, Rise/fall time, 25 ns typ.
- Built rugged for tough environments
- Wide operating temperature, -55°C to 100°C

Typical Applications

- Cellular
- ISM, WCDMA, WIMAX
- PCN
- Automated switching networks
- Military

General Description

The ZFSWA2-63DR+ is a 50Ω high isolation, absorptive SPDT RF switch designed for wireless applications, covering a broad frequency range from 500 to 6000 MHz with low insertion loss. The ZFSWA2-63DR+ operates on a single supply voltage in the range of +3V to +5V. This unit includes an internal CMOS driver. The ZFSWA2-63DR+ switch comes in a rugged built case for tough environments.



Generic photo used for illustration purposes only

ZFSWA2-63DR+

CASE STYLE: ZZ1322

Connectors	Model
SMA	ZFSWA2-63DR+
BRACKET (OPTION "B")	

+RoHS Compliant

The +Suffix identifies RoHS Compliance. See our web site for RoHS Compliance methodologies and qualifications

Schematic and Application Circuit

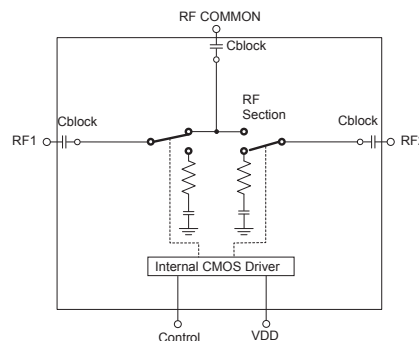

Notes

- Performance and quality attributes and conditions not expressly stated in this specification document are intended to be excluded and do not form a part of this specification document.
- Electrical specifications and performance data contained in this specification document are based on Mini-Circuit's applicable established test performance criteria and measurement instructions.
- The parts covered by this specification document are subject to Mini-Circuits standard limited warranty and terms and conditions (collectively, "Standard Terms"); Purchasers of this part are entitled to the rights and benefits contained therein. For a full statement of the Standard Terms and the exclusive rights and remedies thereunder, please visit Mini-Circuits' website at www.minicircuits.com/MCLStore/terms.jsp



RF Electrical Specifications, 500 - 6000 MHz, $T_{AMB}=25^{\circ}\text{C}$, $V_{DD}=+3\text{V to }+5\text{V}$

Parameter	Condition	Min.	Typ.	Max.	Units
Frequency Range		500		6000	MHz
Insertion Loss	500 MHz		1.0	1.3	dB
	1000 MHz		1.15	1.5	
	2000 MHz		1.4	1.7	
	4000 MHz		1.7	2.1	
	6000 MHz		2.0	2.6	
Isolation between Common port and RF1/RF2 Ports	500 to 2000 MHz	50	65		dB
	2000 to 4000 MHz	48	57		
	4000 to 6000 MHz	35	45		
Isolation between RF1 and RF2 ports	500 to 2000 MHz	50	60		dB
	2000 to 4000 MHz	43	50		
	4000 to 6000 MHz	35	45		
Return Loss (ON STATE)	500 to 2000 MHz		20		dB
	2000 to 4000 MHz		17		
	4000 to 6000 MHz		15		
Return Loss @ RF1/RF2 ports (OFF STATE)	500 to 2000 MHz		17		dB
	2000 to 4000 MHz		19		
	4000 to 6000 MHz		16		
Input IP3	$V_{DD}=3\text{V}$, 500 to 2000 MHz		47		dBm
	2000 to 6000 MHz		40		
	$V_{DD}=5\text{V}$, 500 to 2000 MHz		49		
	2000 to 6000 MHz		44		
Input 1dB Compression ⁽¹⁾	$V_{DD}=3\text{V}$, 500 to 2000 MHz		24		dBm
	2000 to 6000 MHz		24		
	$V_{DD}=5\text{V}$, 500 to 2000 MHz		30		
	2000 to 6000 MHz		27		

DC Electrical Specifications

VDD, Supply Voltage		3		5	V
Supply Current ⁽²⁾	$V_{DD}=5\text{V}$		50		μA
Control Voltage Low		0		0.5	V
Control Voltage High ⁽³⁾		2.7 ⁽⁴⁾		V_{DD}	V
Control Current			5		μA

Switching Specifications

Rise/Fall Time (10 to 90% or 90 to 10% RF)	$V_{DD}=5\text{V}$		25		nSec
Switching Time (50% CTRL to 90/10% RF)	$V_{DD}=5\text{V}$		35		nSec
Video Feed through (Control 0-5V, Frequency 1 MHz)	$V_{DD}=5\text{V}$		30		mV_{P-P}

Notes:

- Note absolute maximum rating for input and dissipated power. At 5V, over 2000-6000 MHz, 0.2 dB compression.
- Increases with switching repetition rate. See graph.
- CMOS interface latch-up condition may occur when logic high signal is applied prior to power supply.
- 3.5V for $V_{DD}=4$ to 5V

Absolute Maximum Ratings

Parameter	Ratings
Operating Temperature	-55°C to 100°C
Storage Temperature	-55°C to 100°C
V_{DD} , Supply Voltage	2.7 to 5.5V
Voltage Control	-0.2V Min. V_{DD} Max.
RF input power	1Watt
Dissipated Power at 25°C	370mW
ESD, HBM	Class 1A (250 to <500V) per JESD22-A114
ESD, MM	Class A (passes 50V) per JESD22-A115
ESD, CDM	Class III (500 to <1000V) per JESD22-C101

Notes

- Performance and quality attributes and conditions not expressly stated in this specification document are intended to be excluded and do not form a part of this specification document.
- Electrical specifications and performance data contained in this specification document are based on Mini-Circuit's applicable established test performance criteria and measurement instructions.
- The parts covered by this specification document are subject to Mini-Circuits standard limited warranty and terms and conditions (collectively, "Standard Terms"); Purchasers of this part are entitled to the rights and benefits contained therein. For a full statement of the Standard Terms and the exclusive rights and remedies thereunder, please visit Mini-Circuits' website at www.minicircuits.com/MCLStore/terms.jsp



Truth Table (State of control voltage selects the desired switch state)

State of Control Voltage	Switch State - RF Common to	
	RF1	RF2
Low	ON	OFF
High	OFF	ON
ON- low insertion loss state OFF- Isolation State		

Coaxial Configuration

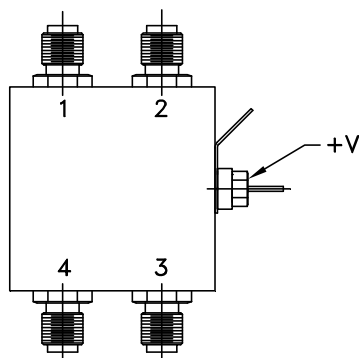

Coaxial Connections

Function	Port Number	Description
RF COM	1	RF Common/ SUM Port
RF1	4	RF Out #1/In Port #1
RF2	3	RF Out #2/In Port #2
Control	2	CMOS Control IN
VDD	V+	Supply Voltage
GND	Case	RF Ground

Notes

- A. Performance and quality attributes and conditions not expressly stated in this specification document are intended to be excluded and do not form a part of this specification document.
- B. Electrical specifications and performance data contained in this specification document are based on Mini-Circuit's applicable established test performance criteria and measurement instructions.
- C. The parts covered by this specification document are subject to Mini-Circuits standard limited warranty and terms and conditions (collectively, "Standard Terms"); Purchasers of this part are entitled to the rights and benefits contained therein. For a full statement of the Standard Terms and the exclusive rights and remedies thereunder, please visit Mini-Circuits' website at www.minicircuits.com/MCLStore/terms.jsp



Outline Drawing (ZZ1322)

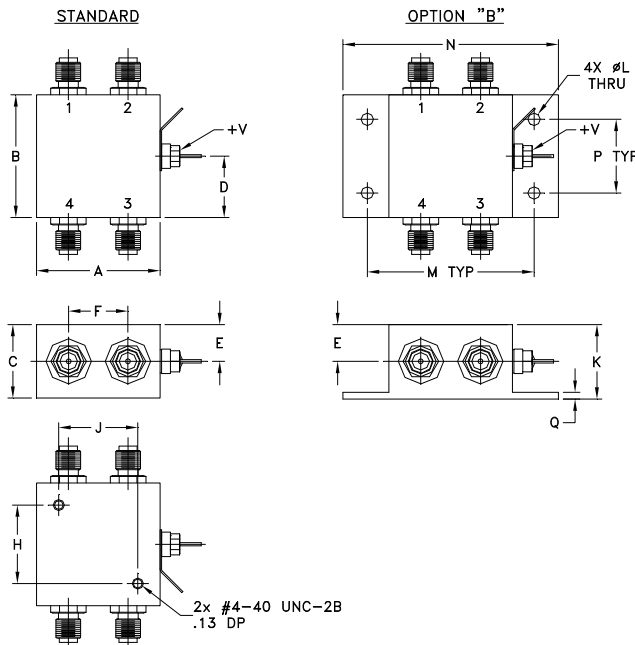

Outline Dimensions (inch / mm)

A	B	C	D	E	F	G	H	J	K	L	M	N	P	Q	wt
1.25	1.25	0.75	0.63	0.38	0.6	--	0.800	0.800	0.76	0.125	1.688	2.18	0.75	0.07	grams
31.75	31.75	19.05	16.00	9.65	15.24	--	20.32	20.32	19.30	3.18	42.88	55.37	19.05	1.78	85

Additional Detailed Technical Information

Additional information is available on our web site. To access this information enter the model number on our web site home page.

Performance data, graphs

Case Style: ZZ1322

Environmental Ratings: ENV28

Pricing & Availability Information

Notes

- A. Performance and quality attributes and conditions not expressly stated in this specification document are intended to be excluded and do not form a part of this specification document.
- B. Electrical specifications and performance data contained in this specification document are based on Mini-Circuit's applicable established test performance criteria and measurement instructions.
- C. The parts covered by this specification document are subject to Mini-Circuits standard limited warranty and terms and conditions (collectively, "Standard Terms"); Purchasers of this part are entitled to the rights and benefits contained therein. For a full statement of the Standard Terms and the exclusive rights and remedies thereunder, please visit Mini-Circuits' website at www.minicircuits.com/MCLStore/terms.jsp



RF Switch SPDT

ZFSWA2-63DR+

Typical Performance Data

RF (MHz)	INSERTION LOSS				RF (MHz)	ISOLATION			
	VDD=+3V (dB)		VDD=+5V (dB)			VDD=+3V (dB)		VDD=+5V (dB)	
	RF COM-RF1	RF COM-RF2	RF COM-RF1	RF COM-RF2		RF COM-RF1	RF COM-RF2	RF COM-RF1	RF COM-RF2
100.00	0.74	0.84	0.76	0.83	100.00	58.80	75.25	59.59	76.39
200.00	0.77	0.88	0.79	0.87	200.00	60.34	72.64	60.69	73.58
300.00	0.80	0.90	0.82	0.89	300.00	62.00	71.77	62.34	72.53
400.00	0.82	0.92	0.84	0.90	400.00	63.38	71.45	63.58	71.98
450.00	0.83	0.92	0.85	0.91	450.00	63.72	70.74	63.98	71.54
500.00	0.84	0.93	0.86	0.92	500.00	64.11	70.77	64.22	71.24
550.00	0.86	0.95	0.88	0.94	550.00	64.38	70.48	64.46	70.96
600.00	0.87	0.95	0.88	0.94	600.00	64.42	70.17	64.53	70.53
800.00	0.95	1.02	0.96	1.01	800.00	64.38	68.88	64.39	69.09
1000.00	0.95	1.03	0.96	1.01	1000.00	63.54	67.39	63.65	67.62
1200.00	0.97	1.06	0.99	1.04	1200.00	62.41	65.99	62.49	66.39
1400.00	1.02	1.11	1.03	1.09	1400.00	61.43	64.97	61.62	65.24
1600.00	1.05	1.14	1.06	1.12	1600.00	60.31	63.85	60.88	64.16
1800.00	1.08	1.16	1.09	1.14	1800.00	59.28	62.43	60.34	63.12
2000.00	1.12	1.19	1.13	1.17	2000.00	59.11	61.63	58.95	61.30
2200.00	1.15	1.21	1.16	1.19	2200.00	58.70	60.55	59.02	60.92
2400.00	1.17	1.24	1.18	1.22	2400.00	58.53	59.48	58.86	60.00
2600.00	1.19	1.28	1.20	1.25	2600.00	58.33	58.60	58.61	59.05
2800.00	1.21	1.32	1.22	1.29	2800.00	58.46	57.96	58.55	57.67
3000.00	1.25	1.35	1.26	1.33	3000.00	58.72	57.58	59.15	57.41
3200.00	1.27	1.36	1.28	1.33	3200.00	58.91	56.94	59.50	57.04
3400.00	1.29	1.36	1.30	1.33	3400.00	59.39	56.28	59.86	56.49
3600.00	1.32	1.38	1.32	1.35	3600.00	59.90	55.04	60.65	55.75
3800.00	1.34	1.41	1.35	1.38	3800.00	60.07	53.32	61.87	54.80
4000.00	1.36	1.44	1.37	1.42	4000.00	61.93	53.49	63.16	54.12
4200.00	1.38	1.49	1.39	1.47	4200.00	62.29	53.68	63.01	53.84
4400.00	1.39	1.52	1.41	1.50	4400.00	60.21	53.73	60.26	53.79
4600.00	1.40	1.54	1.42	1.52	4600.00	57.41	53.76	57.86	53.62
4800.00	1.42	1.55	1.43	1.52	4800.00	54.82	53.91	55.29	53.80
5000.00	1.43	1.56	1.44	1.54	5000.00	52.42	54.31	53.24	54.02
5200.00	1.45	1.60	1.46	1.58	5200.00	50.01	54.91	50.86	54.23
5400.00	1.47	1.66	1.48	1.62	5400.00	47.65	55.07	48.08	54.29
5600.00	1.50	1.71	1.49	1.67	5600.00	45.36	54.52	45.32	53.57
5800.00	1.55	1.76	1.53	1.71	5800.00	43.43	52.90	42.20	51.22
5950.00	1.60	1.78	1.60	1.74	5950.00	42.60	51.57	39.75	48.71
6000.00	1.62	1.80	1.63	1.76	6000.00	42.45	51.07	39.13	47.98
6050.00	1.64	1.81	1.65	1.77	6050.00	42.39	50.73	38.72	47.48
6200.00	1.69	1.85	1.70	1.81	6200.00	42.32	49.65	38.96	47.26
6400.00	1.77	1.93	1.73	1.86	6400.00	42.23	48.46	40.59	48.13
6600.00	1.88	2.06	1.80	1.96	6600.00	41.85	47.11	41.58	48.21
6800.00	2.02	2.20	1.92	2.07	6800.00	41.26	45.24	41.94	47.46

RF Switch SPDT

ZFSWA2-63DR+

Typical Performance Data

RF (MHz)	VSWR (:1)								RF (MHz)	VSWR (:1)			
	VDD=+3V				VDD=+5V					VDD=+3V		VDD=+5V	
	RF COM (ON1)	RF COM (ON2)	RF1 (ON)	RF2 (ON)	RF COM (ON1)	RF COM (ON2)	RF1 (ON)	RF2 (ON)		RF1 (OFF)	RF2 (OFF)	RF1 (OFF)	RF2 (OFF)
100.00	1.17	1.15	1.16	1.14	1.18	1.16	1.17	1.15	100.00	5.11	5.00	5.05	4.98
200.00	1.17	1.14	1.16	1.14	1.17	1.15	1.17	1.14	200.00	2.53	2.52	2.53	2.52
300.00	1.17	1.14	1.16	1.13	1.18	1.14	1.17	1.14	300.00	1.97	1.97	1.98	1.99
400.00	1.17	1.13	1.16	1.13	1.18	1.14	1.17	1.14	400.00	1.75	1.76	1.77	1.78
450.00	1.17	1.13	1.16	1.13	1.18	1.14	1.17	1.14	450.00	1.68	1.69	1.70	1.72
500.00	1.17	1.13	1.16	1.13	1.18	1.14	1.17	1.13	500.00	1.63	1.65	1.65	1.67
550.00	1.17	1.13	1.16	1.12	1.18	1.14	1.17	1.13	550.00	1.60	1.61	1.62	1.64
600.00	1.17	1.13	1.16	1.12	1.18	1.14	1.17	1.13	600.00	1.57	1.58	1.59	1.61
800.00	1.18	1.15	1.15	1.12	1.18	1.15	1.16	1.13	800.00	1.50	1.51	1.53	1.54
1000.00	1.18	1.16	1.13	1.11	1.18	1.17	1.14	1.12	1000.00	1.46	1.48	1.49	1.51
1200.00	1.18	1.18	1.12	1.10	1.18	1.18	1.12	1.11	1200.00	1.44	1.45	1.47	1.48
1400.00	1.19	1.19	1.11	1.09	1.19	1.18	1.11	1.09	1400.00	1.43	1.43	1.46	1.47
1600.00	1.20	1.19	1.09	1.07	1.20	1.19	1.10	1.07	1600.00	1.42	1.42	1.45	1.45
1800.00	1.22	1.21	1.08	1.06	1.22	1.21	1.09	1.06	1800.00	1.42	1.41	1.45	1.45
2000.00	1.24	1.24	1.08	1.06	1.23	1.23	1.07	1.06	2000.00	1.42	1.41	1.45	1.45
2200.00	1.24	1.27	1.06	1.07	1.24	1.26	1.06	1.06	2200.00	1.43	1.42	1.46	1.45
2400.00	1.25	1.29	1.05	1.07	1.25	1.28	1.04	1.05	2400.00	1.44	1.42	1.47	1.45
2600.00	1.26	1.29	1.03	1.05	1.26	1.29	1.04	1.03	2600.00	1.45	1.43	1.48	1.46
2800.00	1.27	1.28	1.03	1.02	1.26	1.28	1.05	1.01	2800.00	1.46	1.44	1.49	1.47
3000.00	1.27	1.27	1.05	1.01	1.28	1.27	1.08	1.03	3000.00	1.47	1.45	1.50	1.48
3200.00	1.28	1.25	1.09	1.03	1.29	1.26	1.12	1.04	3200.00	1.47	1.46	1.51	1.49
3400.00	1.30	1.26	1.13	1.05	1.31	1.26	1.15	1.07	3400.00	1.47	1.47	1.51	1.50
3600.00	1.31	1.26	1.16	1.07	1.33	1.27	1.20	1.10	3600.00	1.46	1.48	1.50	1.52
3800.00	1.33	1.26	1.19	1.11	1.35	1.27	1.23	1.15	3800.00	1.45	1.49	1.50	1.53
4000.00	1.34	1.26	1.22	1.16	1.36	1.28	1.26	1.20	4000.00	1.44	1.49	1.49	1.54
4200.00	1.36	1.25	1.24	1.21	1.38	1.27	1.28	1.25	4200.00	1.43	1.50	1.47	1.55
4400.00	1.36	1.24	1.24	1.25	1.39	1.27	1.29	1.29	4400.00	1.41	1.51	1.46	1.56
4600.00	1.35	1.24	1.24	1.27	1.39	1.28	1.29	1.30	4600.00	1.40	1.53	1.45	1.57
4800.00	1.35	1.25	1.24	1.28	1.39	1.29	1.29	1.32	4800.00	1.39	1.53	1.44	1.58
5000.00	1.35	1.29	1.23	1.30	1.38	1.32	1.28	1.35	5000.00	1.38	1.54	1.43	1.60
5200.00	1.34	1.31	1.22	1.33	1.37	1.35	1.27	1.38	5200.00	1.38	1.55	1.42	1.61
5400.00	1.34	1.32	1.20	1.35	1.36	1.35	1.25	1.42	5400.00	1.37	1.55	1.42	1.62
5600.00	1.33	1.31	1.19	1.36	1.36	1.34	1.25	1.43	5600.00	1.37	1.56	1.43	1.62
5800.00	1.35	1.32	1.19	1.36	1.36	1.34	1.24	1.41	5800.00	1.36	1.56	1.43	1.63
5950.00	1.37	1.35	1.19	1.35	1.36	1.35	1.24	1.40	5950.00	1.36	1.56	1.42	1.62
6000.00	1.39	1.38	1.20	1.36	1.37	1.37	1.24	1.39	6000.00	1.35	1.56	1.42	1.63
6050.00	1.39	1.39	1.20	1.36	1.37	1.38	1.24	1.39	6050.00	1.35	1.55	1.41	1.62
6200.00	1.43	1.46	1.22	1.38	1.39	1.44	1.26	1.39	6200.00	1.35	1.56	1.40	1.62
6400.00	1.51	1.57	1.27	1.43	1.46	1.54	1.28	1.43	6400.00	1.34	1.54	1.39	1.62
6600.00	1.61	1.69	1.34	1.51	1.56	1.65	1.33	1.50	6600.00	1.34	1.54	1.39	1.61
6800.00	1.74	1.82	1.43	1.63	1.68	1.76	1.41	1.61	6800.00	1.34	1.52	1.39	1.59

RF Switch SPDT

ZFSWA2-63DR+

Typical Performance Data

RF (MHz)	INPUT IP3				RF (MHz)	INPUT POWER @ 1dB COMPRESSION	
	VDD=+3V (dBm)		VDD =+5V (dBm)			VDD=+3V (dBm)	VDD =+5V (dBm)
	RF COM-RF1	RF COM-RF2	RF COM-RF1	RF COM-RF2		Pin	Pin
500.00	48.31	48.44	51.09	52.07	500.00	23.96	30.61
550.00	47.68	47.89	50.11	51.10	600.00	23.87	30.60
600.00	47.90	48.19	50.34	51.35	700.00	23.73	30.52
650.00	48.50	48.80	51.18	52.39	800.00	23.78	30.45
700.00	49.00	49.44	51.06	52.09	900.00	23.57	30.34
750.00	48.30	48.59	50.48	51.59	1000.00	23.41	30.20
800.00	46.96	47.26	49.21	50.01	1100.00	23.81	30.31
850.00	46.26	46.60	48.80	49.28	1200.00	23.76	30.33
900.00	46.38	46.65	49.09	49.57	1300.00	23.88	30.43
950.00	46.22	46.57	49.39	50.23	1400.00	24.03	30.43
1000.00	47.01	47.71	50.54	51.48	1500.00	24.24	30.64
1250.00	45.16	45.75	48.62	49.35	1600.00	24.23	30.67
1500.00	46.04	46.37	49.04	49.61	1700.00	24.46	30.79
1750.00	45.22	45.78	48.69	49.15	1800.00	24.35	30.60
2000.00	43.41	44.05	46.53	47.23	1900.00	24.30	30.48
2250.00	43.00	43.88	46.43	47.21	2000.00	24.29	30.62
2500.00	41.60	42.73	45.28	46.29			
2750.00	42.22	42.86	45.72	46.54			
3000.00	42.10	42.79	45.65	46.61			
3250.00	40.72	41.34	44.19	45.24			
3500.00	40.91	41.27	44.62	45.61			
3750.00	41.21	40.94	45.35	45.62			
4000.00	40.58	39.35	44.60	43.72			
4250.00	40.61	40.00	44.58	44.15			
4500.00	39.55	38.99	43.36	43.13			
4750.00	38.62	38.58	42.49	42.76			
5000.00	39.17	39.38	43.01	43.36			
5250.00	38.69	38.86	43.10	43.11			
5500.00	37.95	37.69	42.12	41.84			
5750.00	37.84	37.60	41.68	41.62			
6000.00	36.56	36.50	41.02	41.21			

At VDD =+5V and VCTL = 0/5 V		
Rep Rate (MHz)	IDD (micro A)	
	Min	Max
0.00	3.00	18.30
1.00	87.70	89.80
5.00	408.20	413.10
10.00	772.00	786.00

RF Switch SPDT

ZFSWA2-63DR+

Typical Performance Data

RF (MHz)	INSERTION LOSS @ VDD=+5V OVER TEMPERATURE						RF (MHz)	ISOLATION @ VDD=+5V OVER TEMPERATURE					
	RF COM-RF1 (dB)			RF COM-RF2 (dB)				RF COM-RF1 (dB)			RF COM-RF2 (dB)		
	-55°C	+25°C	+100°C	-55°C	+25°C	+100°C		-55°C	+25°C	+100°C	-55°C	+25°C	+100°C
100.00	0.58	0.75	0.87	0.72	0.86	0.97	100.00	58.83	59.55	60.28	76.79	76.49	76.06
200.00	0.60	0.78	0.91	0.73	0.89	1.01	200.00	59.37	60.68	61.99	73.19	73.48	73.62
300.00	0.60	0.81	0.95	0.73	0.92	1.04	300.00	61.03	62.56	63.78	72.22	72.92	73.23
400.00	0.60	0.83	0.97	0.73	0.93	1.06	400.00	62.13	63.57	64.71	71.34	71.83	72.52
450.00	0.61	0.84	0.99	0.73	0.94	1.08	450.00	62.56	63.91	64.84	70.84	71.31	71.88
500.00	0.61	0.85	1.01	0.73	0.95	1.09	500.00	62.39	64.40	65.36	71.40	72.52	73.29
550.00	0.62	0.87	1.02	0.74	0.97	1.11	550.00	63.31	64.40	65.30	70.10	70.63	71.76
600.00	0.62	0.88	1.03	0.74	0.97	1.12	600.00	63.75	64.61	65.21	70.03	70.76	71.43
800.00	0.66	0.95	1.12	0.78	1.04	1.20	800.00	63.73	64.33	64.39	68.45	69.17	69.75
1000.00	0.65	0.95	1.14	0.77	1.04	1.22	1000.00	63.20	63.49	63.69	66.60	67.76	68.47
1200.00	0.64	0.97	1.17	0.76	1.07	1.26	1200.00	62.04	62.45	62.67	65.43	66.25	66.90
1400.00	0.67	1.01	1.22	0.79	1.11	1.31	1400.00	60.91	61.46	61.90	64.42	65.26	66.02
1600.00	0.69	1.04	1.26	0.80	1.14	1.35	1600.00	60.11	60.86	61.38	62.76	64.29	64.90
1800.00	0.68	1.06	1.29	0.79	1.15	1.38	1800.00	59.19	60.17	60.77	61.86	62.88	63.73
2000.00	0.69	1.09	1.33	0.80	1.18	1.41	2000.00	58.47	59.49	60.29	60.80	61.97	62.70
2200.00	0.72	1.14	1.38	0.81	1.21	1.45	2200.00	57.93	59.19	59.98	59.52	60.81	61.56
2400.00	0.72	1.16	1.42	0.82	1.24	1.50	2400.00	57.48	58.97	59.66	58.61	59.78	60.41
2600.00	0.71	1.17	1.45	0.83	1.27	1.55	2600.00	57.24	58.77	59.63	57.74	58.94	59.44
2800.00	0.71	1.20	1.49	0.83	1.30	1.60	2800.00	57.53	58.93	59.52	57.26	58.46	58.80
3000.00	0.72	1.22	1.53	0.84	1.32	1.64	3000.00	57.56	59.20	59.68	56.78	57.44	57.65
3200.00	0.73	1.24	1.56	0.84	1.34	1.67	3200.00	57.76	59.51	59.87	56.39	57.09	57.13
3400.00	0.73	1.26	1.60	0.82	1.34	1.69	3400.00	58.09	59.91	60.25	55.56	56.18	56.19
3600.00	0.75	1.29	1.64	0.82	1.36	1.71	3600.00	58.36	60.50	60.86	54.83	55.32	55.34
3800.00	0.74	1.30	1.67	0.83	1.39	1.76	3800.00	59.08	62.01	62.73	54.07	54.57	54.59
4000.00	0.75	1.33	1.71	0.86	1.43	1.81	4000.00	58.87	63.70	66.41	53.00	53.67	54.04
4200.00	0.76	1.36	1.75	0.88	1.47	1.87	4200.00	58.15	63.84	71.15	52.72	53.58	53.83
4400.00	0.75	1.36	1.76	0.89	1.49	1.90	4400.00	56.33	61.11	65.96	52.79	53.73	53.92
4600.00	0.75	1.38	1.79	0.90	1.52	1.94	4600.00	54.22	58.07	61.47	52.92	53.44	53.49
4800.00	0.74	1.39	1.81	0.89	1.53	1.96	4800.00	52.40	55.59	58.12	52.86	53.74	53.57
5000.00	0.74	1.39	1.81	0.88	1.53	1.98	5000.00	50.52	53.33	55.29	52.81	53.39	53.24
5200.00	0.74	1.40	1.84	0.93	1.58	2.03	5200.00	48.44	50.67	52.41	52.85	53.67	53.64
5400.00	0.74	1.41	1.85	0.97	1.63	2.08	5400.00	46.19	48.05	50.01	52.61	54.19	54.24
5600.00	0.76	1.44	1.90	0.99	1.66	2.13	5600.00	43.90	45.60	46.94	51.96	54.17	55.12
5800.00	0.78	1.50	1.98	1.02	1.71	2.20	5800.00	41.87	43.18	44.26	50.84	53.74	56.09
5950.00	0.80	1.53	2.01	1.00	1.73	2.25	5950.00	40.75	42.02	42.97	49.88	52.92	55.46
6000.00	0.82	1.55	2.05	1.01	1.75	2.27	6000.00	40.58	41.89	42.79	49.66	52.57	54.75
6050.00	0.84	1.58	2.08	1.03	1.78	2.31	6050.00	40.48	41.86	42.74	49.66	52.23	54.40
6200.00	0.85	1.59	2.10	1.02	1.77	2.32	6200.00	40.61	42.03	42.95	49.35	51.57	53.31
6400.00	0.88	1.67	2.22	1.06	1.85	2.45	6400.00	40.88	42.61	43.55	48.76	51.20	52.55
6600.00	0.97	1.75	2.31	1.15	1.94	2.54	6600.00	40.85	42.77	43.83	47.89	49.82	51.24
6800.00	1.07	1.88	2.44	1.26	2.06	2.66	6800.00	40.32	42.49	43.79	46.16	48.70	50.13

RF Switch SPDT

ZFSWA2-63DR+

Typical Performance Data

RF (MHz)	VSWR @ VDD=+5V OVER TEMPERATURE (:1)												RF (MHz)	VSWR @ VDD=+5V OVER TEMPERATURE (:1)					
	RF COM (ON1)			RF COM (ON2)			RF1 (ON)			RF2 (ON)				RF1 (OFF)			RF2 (OFF)		
	-55°C	+25°C	+100°C	-55°C	+25°C	+100°C	-55°C	+25°C	+100°C	-55°C	+25°C	+100°C		-55°C	+25°C	+100°C	-55°C	+25°C	+100°C
100.00	1.15	1.18	1.20	1.12	1.16	1.18	1.14	1.17	1.20	1.11	1.15	1.18	100.00	5.57	5.07	4.77	5.46	4.99	4.71
200.00	1.14	1.18	1.20	1.11	1.15	1.18	1.13	1.17	1.19	1.11	1.14	1.17	200.00	2.59	2.53	2.53	2.57	2.52	2.53
300.00	1.15	1.18	1.21	1.10	1.14	1.17	1.13	1.17	1.19	1.10	1.14	1.17	300.00	1.94	1.98	2.08	1.93	1.99	2.09
400.00	1.14	1.18	1.21	1.11	1.15	1.17	1.14	1.17	1.19	1.09	1.13	1.16	400.00	1.67	1.77	1.89	1.67	1.77	1.90
450.00	1.14	1.18	1.21	1.10	1.14	1.17	1.14	1.17	1.19	1.10	1.13	1.16	450.00	1.59	1.71	1.85	1.60	1.71	1.86
500.00	1.14	1.18	1.20	1.09	1.14	1.16	1.14	1.17	1.19	1.10	1.14	1.17	500.00	1.53	1.66	1.80	1.54	1.68	1.82
550.00	1.15	1.18	1.21	1.10	1.14	1.17	1.13	1.16	1.19	1.09	1.13	1.16	550.00	1.48	1.62	1.77	1.49	1.64	1.79
600.00	1.14	1.18	1.21	1.10	1.14	1.17	1.14	1.17	1.19	1.10	1.14	1.17	600.00	1.45	1.59	1.75	1.46	1.61	1.77
800.00	1.15	1.18	1.21	1.11	1.16	1.19	1.13	1.16	1.19	1.09	1.13	1.16	800.00	1.35	1.52	1.70	1.36	1.54	1.71
1000.00	1.14	1.17	1.20	1.12	1.17	1.20	1.11	1.14	1.17	1.08	1.12	1.15	1000.00	1.31	1.49	1.67	1.32	1.51	1.68
1200.00	1.14	1.17	1.20	1.13	1.18	1.21	1.10	1.13	1.16	1.07	1.11	1.14	1200.00	1.28	1.47	1.66	1.29	1.48	1.66
1400.00	1.15	1.18	1.21	1.15	1.19	1.21	1.08	1.11	1.14	1.05	1.09	1.12	1400.00	1.26	1.46	1.64	1.26	1.45	1.63
1600.00	1.16	1.19	1.20	1.15	1.19	1.21	1.07	1.10	1.13	1.05	1.07	1.10	1600.00	1.26	1.45	1.64	1.25	1.45	1.62
1800.00	1.18	1.20	1.22	1.17	1.21	1.23	1.06	1.08	1.11	1.04	1.05	1.08	1800.00	1.25	1.45	1.63	1.25	1.44	1.61
2000.00	1.21	1.23	1.24	1.21	1.24	1.26	1.06	1.07	1.10	1.06	1.05	1.07	2000.00	1.26	1.45	1.62	1.25	1.44	1.60
2200.00	1.21	1.23	1.25	1.23	1.26	1.28	1.04	1.06	1.08	1.06	1.06	1.07	2200.00	1.27	1.46	1.62	1.26	1.45	1.61
2400.00	1.22	1.25	1.28	1.27	1.30	1.32	1.02	1.04	1.06	1.07	1.05	1.06	2400.00	1.28	1.46	1.62	1.26	1.44	1.60
2600.00	1.21	1.25	1.28	1.25	1.29	1.32	1.02	1.04	1.05	1.05	1.04	1.05	2600.00	1.28	1.47	1.62	1.26	1.45	1.60
2800.00	1.22	1.26	1.30	1.24	1.28	1.31	1.05	1.05	1.06	1.03	1.01	1.03	2800.00	1.30	1.49	1.65	1.27	1.47	1.61
3000.00	1.23	1.27	1.31	1.22	1.26	1.30	1.09	1.08	1.07	1.03	1.03	1.02	3000.00	1.31	1.50	1.64	1.29	1.48	1.63
3200.00	1.25	1.28	1.31	1.21	1.25	1.29	1.12	1.11	1.10	1.05	1.04	1.03	3200.00	1.31	1.51	1.66	1.30	1.50	1.64
3400.00	1.27	1.30	1.32	1.22	1.25	1.29	1.17	1.16	1.14	1.08	1.08	1.06	3400.00	1.32	1.52	1.66	1.31	1.51	1.66
3600.00	1.31	1.32	1.33	1.24	1.27	1.30	1.21	1.20	1.18	1.10	1.10	1.10	3600.00	1.31	1.51	1.67	1.31	1.51	1.66
3800.00	1.31	1.32	1.34	1.23	1.25	1.27	1.24	1.24	1.24	1.13	1.15	1.15	3800.00	1.31	1.50	1.66	1.32	1.53	1.68
4000.00	1.35	1.37	1.38	1.26	1.27	1.27	1.26	1.27	1.27	1.17	1.19	1.19	4000.00	1.29	1.48	1.64	1.33	1.53	1.68
4200.00	1.37	1.38	1.40	1.27	1.27	1.28	1.28	1.29	1.30	1.22	1.24	1.25	4200.00	1.30	1.48	1.62	1.35	1.55	1.70
4400.00	1.37	1.39	1.41	1.25	1.25	1.26	1.31	1.31	1.33	1.27	1.28	1.28	4400.00	1.30	1.46	1.60	1.37	1.56	1.70
4600.00	1.35	1.39	1.41	1.25	1.26	1.26	1.32	1.31	1.32	1.31	1.30	1.30	4600.00	1.29	1.44	1.56	1.39	1.56	1.70
4800.00	1.38	1.41	1.42	1.30	1.30	1.30	1.34	1.31	1.30	1.35	1.33	1.33	4800.00	1.30	1.43	1.53	1.40	1.59	1.73
5000.00	1.35	1.36	1.39	1.30	1.30	1.31	1.31	1.28	1.26	1.34	1.33	1.34	5000.00	1.29	1.41	1.49	1.41	1.58	1.71
5200.00	1.35	1.37	1.40	1.36	1.34	1.34	1.33	1.27	1.23	1.41	1.38	1.37	5200.00	1.31	1.40	1.48	1.46	1.62	1.73
5400.00	1.32	1.34	1.36	1.35	1.33	1.32	1.32	1.27	1.21	1.43	1.40	1.37	5400.00	1.33	1.42	1.48	1.49	1.62	1.72
5600.00	1.35	1.36	1.37	1.35	1.32	1.33	1.31	1.25	1.21	1.43	1.39	1.36	5600.00	1.34	1.42	1.50	1.49	1.62	1.72
5800.00	1.38	1.39	1.39	1.39	1.36	1.36	1.30	1.24	1.18	1.46	1.41	1.37	5800.00	1.34	1.41	1.46	1.53	1.65	1.74
5950.00	1.38	1.38	1.37	1.35	1.36	1.38	1.28	1.24	1.20	1.43	1.40	1.37	5950.00	1.34	1.41	1.48	1.54	1.64	1.72
6000.00	1.40	1.39	1.37	1.38	1.38	1.40	1.29	1.25	1.21	1.44	1.40	1.36	6000.00	1.34	1.41	1.49	1.53	1.63	1.71
6050.00	1.43	1.43	1.42	1.42	1.44	1.46	1.30	1.25	1.22	1.46	1.42	1.39	6050.00	1.33	1.39	1.48	1.55	1.64	1.72
6200.00	1.46	1.40	1.38	1.46	1.45	1.47	1.31	1.25	1.24	1.43	1.39	1.37	6200.00	1.35	1.40	1.49	1.53	1.62	1.69
6400.00	1.49	1.47	1.47	1.55	1.56	1.59	1.32	1.30	1.29	1.48	1.45	1.45	6400.00	1.35	1.41	1.49	1.56	1.61	1.67
6600.00	1.61	1.57	1.55	1.70	1.67	1.67	1.40	1.37	1.37	1.54	1.53	1.56	6600.00	1.36	1.41	1.50	1.54	1.59	1.67
6800.00	1.75	1.70	1.65	1.83	1.77	1.77	1.51	1.44	1.43	1.63	1.60	1.64	6800.00	1.39	1.40	1.48	1.55	1.56	1.62

RF Switch SPDT

ZFSWA2-63DR+

Typical Performance Curves

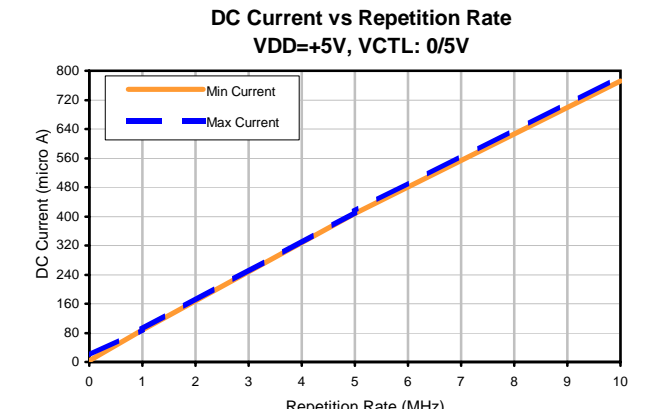
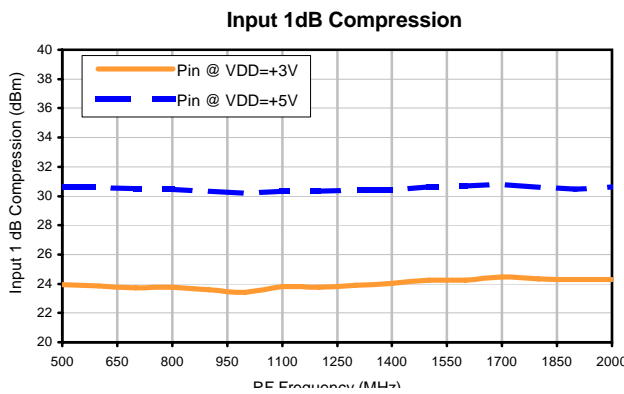
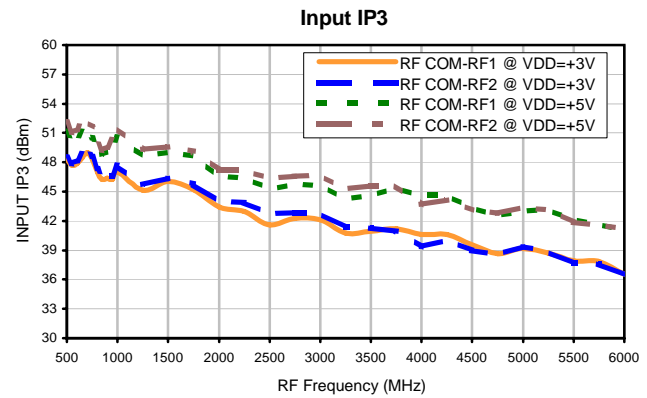
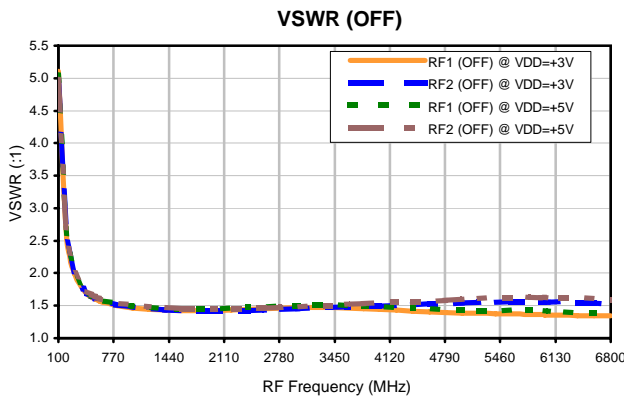
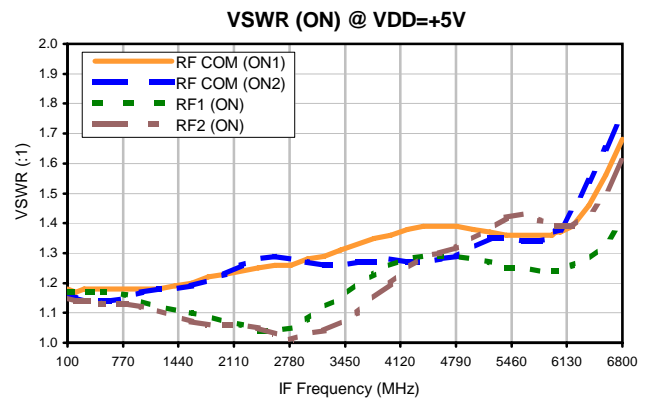
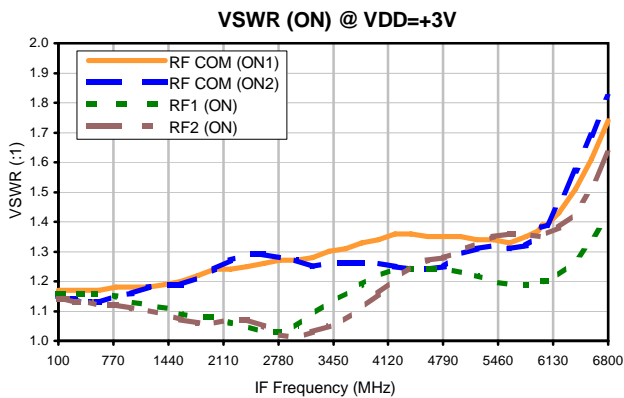
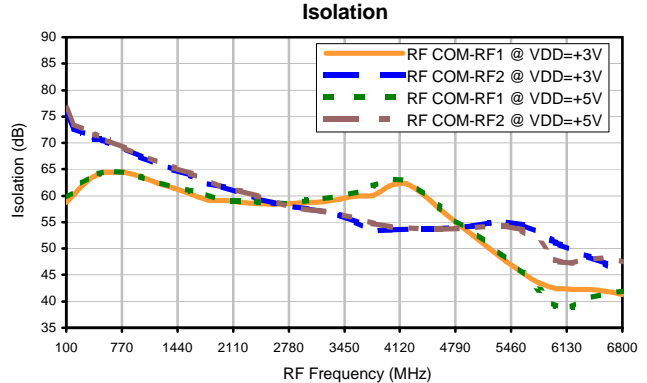
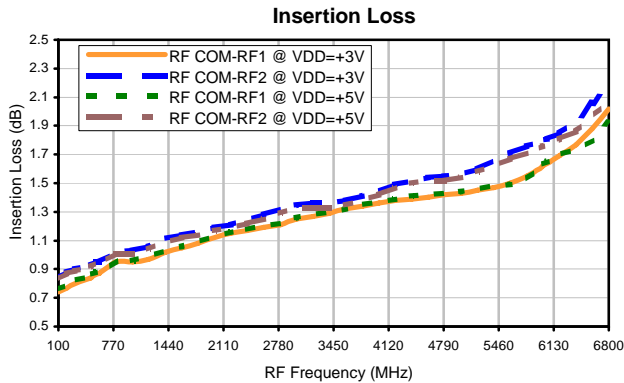

P.O. Box 350186, Brooklyn, New York 11235-0003 (718) 934-4500 Fax (718) 332-4851 For detailed performance specs & shopping online see Mini-Circuits web site



The Design Engineers Search Engine Provides ACTUAL Data Instantly From MIN-CIRCUITS At: www.minicircuits.com

IF/RF MICROWAVE COMPONENTS



Typical Performance Curves

**Insertion Loss @ VDD=+5V over Temperature
RF COM-RF1 & RF COM-RF2**

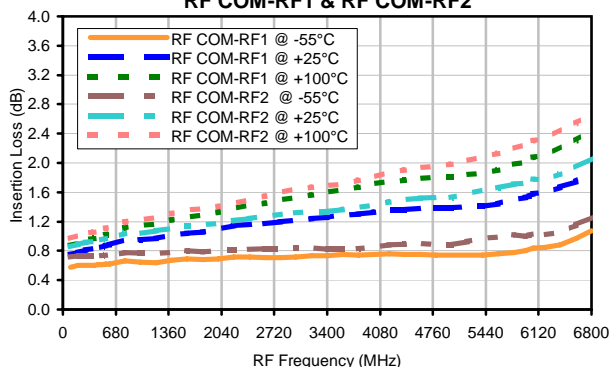

**Isolation @ VDD=+5V over Temperature
RF COM-RF1 & RF COM-RF2**

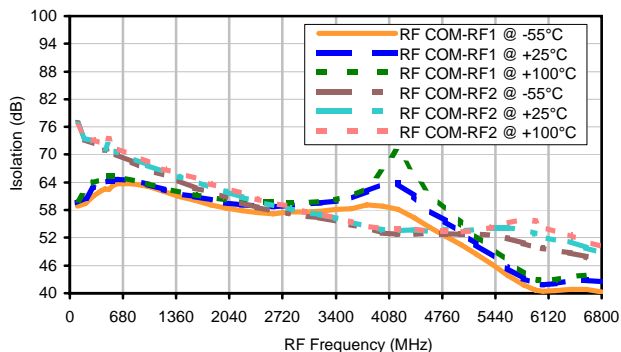

**VSWR @ VDD=+5V over Temperature
RF COM (ON1) & RF COM (ON2)**

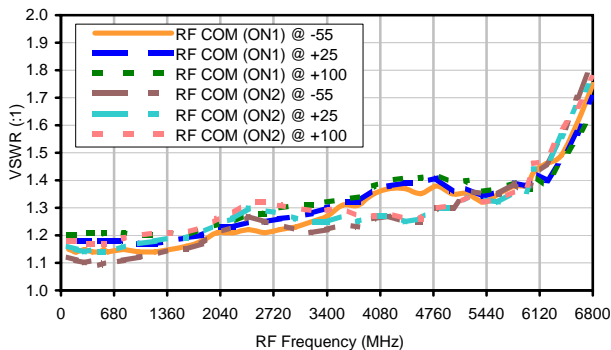

**VSWR @ VDD=+5V over Temperature
RF1(ON) & RF2 (ON)**

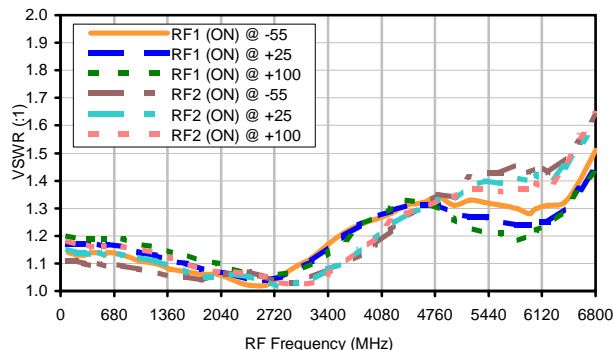

**VSWR @ VDD=+5V over Temperature
RF1(OFF) & RF2 (OFF)**

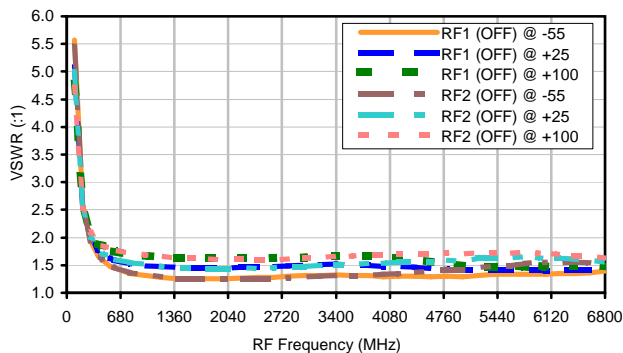

Outline Dimensions

ZZ1322

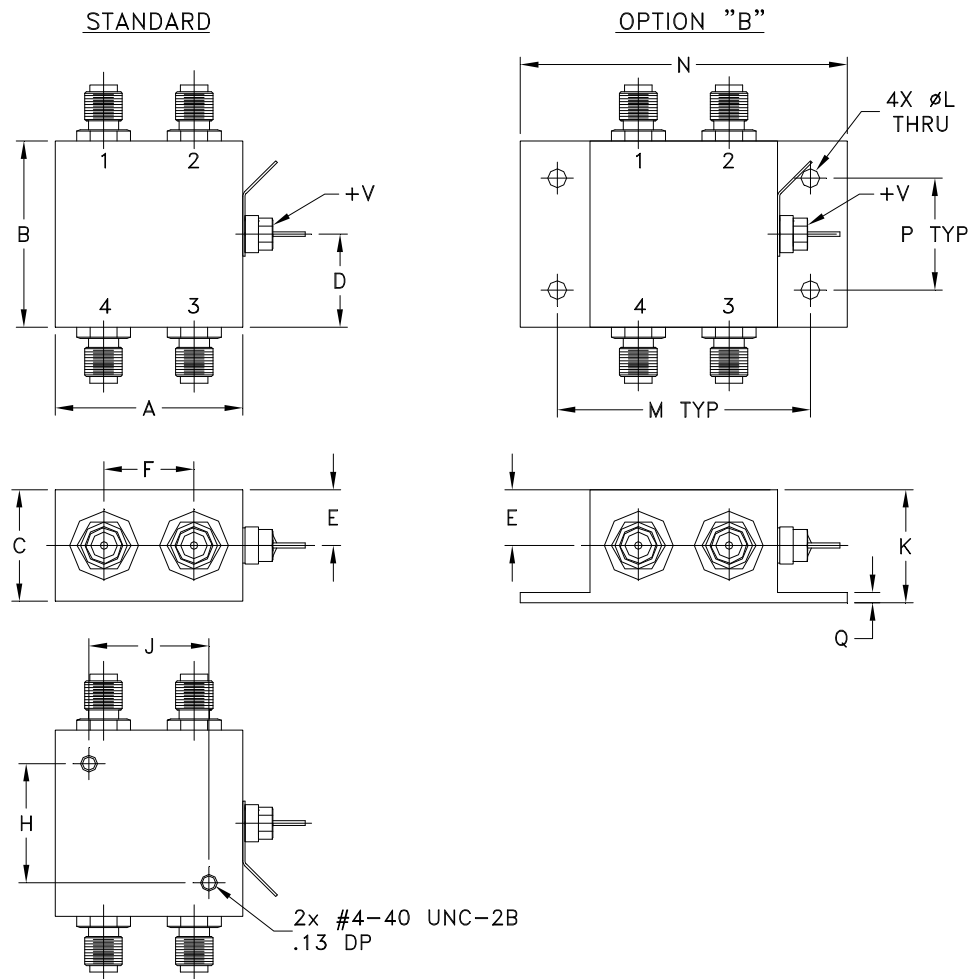

CASE#	A	B	C	D	E	F	G	H	J	K	L	M	N
ZZ1322	1.25 (31.75)	1.25 (31.75)	.75 (19.05)	.63 (16.00)	.38 (9.65)	.60 (15.24)	--	.800 (20.32)	.800 (20.32)	.76 (19.30)	.125 (3.18)	1.688 (42.88)	2.18 (55.37)

CASE#	P	Q	WT.GRAMS
ZZ1322	.750 (19.05)	.07 (1.78)	85.0

Dimensions are in inches (mm). Tolerances: 2 Pl. $\pm .03$; 3 Pl. $\pm .015$

Notes:

- Case material: Aluminum alloy.
- Case finish:
For RoHS Case Styles: Clear chemical conversion coating, non-chrome or trivalent chrome based.
- Mounting bracket available on request. Add suffix B to part number

Mini-Circuits®
ISO 9001 ISO 14001 CERTIFIED

ALL NEW
minicircuits.com

P.O. Box 350166, Brooklyn, New York 11235-0003 (718) 934-4500 Fax (718) 332-4661 For detailed performance specs & shopping online see Mini-Circuits web site



The Design Engineers Search Engine Provides ACTUAL Data Instantly From MINI-CIRCUITS At: www.minicircuits.com

RF/IF MICROWAVE COMPONENTS



All Mini-Circuits products are manufactured under exacting quality assurance and control standards, and are capable of meeting published specifications after being subjected to any or all of the following physical and environmental test.

Specification	Test/Inspection Condition	Reference/Spec
Operating Temperature	-55° to 100°C Ambient Environment	Individual Model Data Sheet
Storage Temperature	-55° to 100° C Ambient Environment	Individual Model Data Sheet
Barometric Pressure	100,000 Feet	MIL-STD-202, Method 105, Condition D
Humidity	90% RH, 65°C Units may require bake-out after humidity to restore full performance.	MIL-STD-202, Method 103
Thermal Shock	-65° to 125°C, 5 cycles	MIL-STD-202, Method 107, Condition B
Vibration (High Frequency)	20g peak, 10-2000 Hz, 12 times in each of three perpendicular directions (total 36)	MIL-STD-202, Method 204, Condition D
Mechanical Shock	100g, 6ms sawtooth, 3 shocks each direction 3 axes (total 18)	MIL-STD-202, Method 213, Condition I