

Coaxial

Power Splitter/Combiner

ZFSC-2-1W+

2 Way-0° 50Ω 1 to 750 MHz



Generic photo used for illustration purposes only
CASE STYLE: K18

Connectors	Model
BNC	ZFSC-2-1W+
SMA	ZFSC-2-1W-S+
N-TYPE	ZFSC-2-1W-N+
BRACKET (OPTION)	

+RoHS Compliant

The +Suffix identifies RoHS Compliance. See our web site for RoHS Compliance methodologies and qualifications

Maximum Ratings

Operating Temperature	-55°C to 100°C
Storage Temperature	-55°C to 100°C
Power Input (as a splitter)	1W max.
Internal Dissipation	0.125W max.

Permanent damage may occur if any of these limits are exceeded.

Coaxial Connections

SUM PORT	3
PORT 1	1
PORT 2	2

Outline Drawing

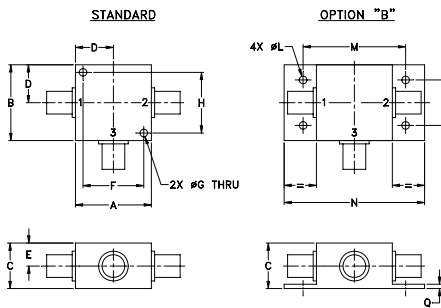

Outline Dimensions (inch/mm)

A	B	C	D	E	F	G	H	J	K	L	M	N	P	Q	wt
1.25	1.25	.75	.63	.38	1.00	.125	1.000	--	--	.125	1.688	2.18	.75	.07	grams
31.75	31.75	19.05	16.00	9.65	25.40	3.18	25.40	--	--	3.18	42.88	55.37	19.05	1.78	70.0

For option B with N-type connectors, dimension "C" increases to 0.94 inches.

Features

- low insertion loss, 0.4 dB typ.
- high isolation, 28 dB typ.
- excellent amplitude unbalance, 0.1 dB typ.
- excellent phase unbalance, 0.5 deg. typ.
- very good return loss, VSWR, 1.15:1 typ.
- rugged shielded case

Applications

- VHF/UHF
- federal & defense communication

Electrical Specifications

FREQ. RANGE (MHz)	ISOLATION (dB)				INSERTION LOSS (dB) ABOVE 3.0 dB				PHASE UNBALANCE (Degrees)			AMPLITUDE UNBALANCE (dB)						
	Typ.	L	Min.	U	Typ.	L	Max.	U	L	M	U	L	M	U				
1-750	30	20	28	20	25	20	0.2	0.5	0.4	0.8	0.8	1.0	2	4	4	0.15	0.15	0.30

L = low range [f_L to $10 f_L$] M = mid range [$10 f_L$ to $f_U/2$] U = upper range [$f_U/2$ to f_U]

Typical Performance Data

Frequency (MHz)	Total Loss ¹ (dB)		Amplitude Unbalance (dB)	Isolation (dB)	Phase Unbalance (deg.)	VSWR S	VSWR 1	VSWR 2
	S-1	S-2						
1.00	3.27	3.27	0.00	31.01	0.01	1.10	1.22	1.21
5.00	3.17	3.16	0.01	38.19	0.02	1.08	1.17	1.16
10.00	3.16	3.16	0.00	38.65	0.14	1.08	1.16	1.16
68.00	3.19	3.19	0.01	26.38	0.07	1.12	1.14	1.14
97.00	3.23	3.23	0.00	25.75	0.09	1.13	1.15	1.15
184.00	3.28	3.28	0.01	25.18	0.09	1.16	1.16	1.15
271.00	3.33	3.31	0.02	24.97	0.20	1.17	1.16	1.16
380.00	3.38	3.35	0.03	24.99	0.24	1.18	1.18	1.17
395.00	3.30	3.28	0.02	24.95	0.21	1.20	1.20	1.19
460.00	3.39	3.36	0.03	25.18	0.22	1.16	1.18	1.17
550.00	3.41	3.36	0.05	25.42	0.31	1.13	1.16	1.14
640.00	3.49	3.43	0.06	25.07	0.36	1.09	1.13	1.11
710.00	3.55	3.48	0.07	23.78	0.48	1.09	1.12	1.11
730.00	3.65	3.58	0.07	23.32	0.59	1.09	1.14	1.12
750.00	3.67	3.61	0.07	22.79	0.58	1.07	1.13	1.11

1. Total Loss = Insertion Loss + 3dB splitter loss.

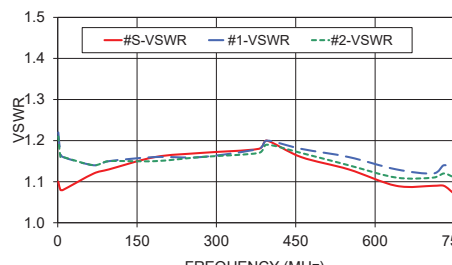
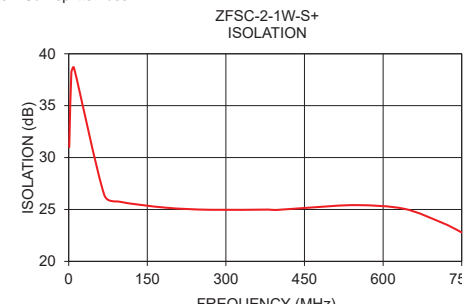
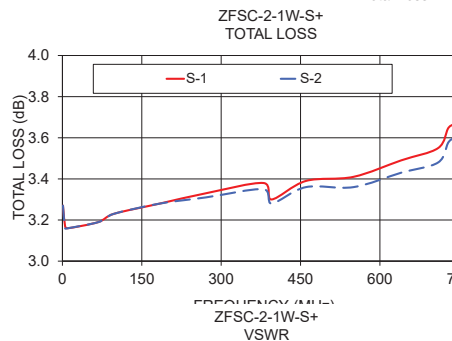

electrical schematic



Notes

- Performance and quality attributes and conditions not expressly stated in this specification document are intended to be excluded and do not form a part of this specification document.
- Electrical specifications and performance data contained in this specification document are based on Mini-Circuit's applicable established test performance criteria and measurement instructions.
- The parts covered by this specification document are subject to Mini-Circuit's standard limited warranty and terms and conditions (collectively, "Standard Terms"); Purchasers of this part are entitled to the rights and benefits contained therein. For a full statement of the Standard Terms and the exclusive rights and remedies thereunder, please visit Mini-Circuit's website at www.minicircuits.com/MCLStore/terms.jsp



2 Way-0° Power Splitter/Combiner

ZFSC-2-1W+

Typical Performance Data

FREQ. (MHz)	TOTAL LOSS ¹ (dB)		AMP. UNBAL. (dB)	ISOLATION (dB)	PHASE UNBAL. (deg.)	FREQ. (MHz)	VSWR (:1)		
	S-1	S-2					S	1	2
1.0	3.27	3.27	0.00	31.01	0.01	1.0	1.10	1.22	1.21
2.0	3.21	3.21	0.01	34.91	0.06	2.0	1.09	1.18	1.18
3.0	3.19	3.19	0.00	36.54	0.02	3.0	1.08	1.17	1.17
4.0	3.18	3.17	0.01	37.52	0.03	4.0	1.08	1.17	1.17
5.0	3.17	3.16	0.01	38.19	0.02	5.0	1.08	1.17	1.16
6.0	3.16	3.16	0.00	38.53	0.01	6.0	1.08	1.16	1.16
7.0	3.17	3.16	0.01	38.85	0.04	7.0	1.08	1.16	1.16
8.0	3.16	3.16	0.01	38.92	0.02	8.0	1.08	1.16	1.16
9.0	3.17	3.16	0.00	38.87	0.02	9.0	1.08	1.16	1.16
10.0	3.16	3.16	0.00	38.65	0.14	10.0	1.08	1.16	1.16
39.0	3.20	3.19	0.00	28.75	0.11	39.0	1.11	1.16	1.16
68.0	3.19	3.19	0.01	26.38	0.07	68.0	1.12	1.14	1.14
97.0	3.23	3.23	0.00	25.75	0.09	97.0	1.13	1.15	1.15
126.0	3.23	3.22	0.02	25.43	0.08	126.0	1.12	1.15	1.15
155.0	3.22	3.22	0.00	25.29	0.12	155.0	1.13	1.14	1.13
184.0	3.28	3.28	0.01	25.18	0.09	184.0	1.16	1.16	1.15
213.0	3.26	3.25	0.01	25.12	0.14	213.0	1.18	1.18	1.18
242.0	3.25	3.23	0.02	25.03	0.17	242.0	1.16	1.18	1.17
271.0	3.33	3.31	0.02	24.97	0.20	271.0	1.17	1.16	1.16
300.0	3.30	3.30	0.00	24.94	0.18	300.0	1.20	1.19	1.19
375.0	3.38	3.35	0.03	25.00	0.25	375.0	1.18	1.18	1.17
380.0	3.38	3.35	0.03	24.99	0.24	380.0	1.18	1.18	1.17
385.0	3.35	3.33	0.02	24.97	0.23	385.0	1.19	1.18	1.18
390.0	3.33	3.30	0.03	24.98	0.27	390.0	1.19	1.19	1.18
395.0	3.30	3.28	0.02	24.95	0.21	395.0	1.20	1.20	1.19
400.0	3.30	3.27	0.03	24.96	0.19	400.0	1.21	1.20	1.20
430.0	3.35	3.32	0.03	25.06	0.30	430.0	1.21	1.22	1.21
460.0	3.39	3.36	0.03	25.18	0.22	460.0	1.16	1.18	1.17
490.0	3.34	3.30	0.04	25.24	0.28	490.0	1.15	1.16	1.15
520.0	3.38	3.34	0.05	25.33	0.31	520.0	1.16	1.18	1.17
550.0	3.41	3.36	0.05	25.42	0.31	550.0	1.13	1.16	1.14
580.0	3.39	3.35	0.04	25.38	0.33	580.0	1.09	1.12	1.10
610.0	3.43	3.38	0.05	25.30	0.43	610.0	1.10	1.13	1.11
640.0	3.49	3.43	0.06	25.07	0.36	640.0	1.09	1.13	1.11
670.0	3.50	3.44	0.06	24.65	0.41	670.0	1.04	1.09	1.07
700.0	3.49	3.43	0.07	23.99	0.54	700.0	1.08	1.11	1.09
710.0	3.55	3.48	0.07	23.78	0.48	710.0	1.09	1.12	1.11
720.0	3.60	3.53	0.07	23.56	0.45	720.0	1.09	1.13	1.12
730.0	3.65	3.58	0.07	23.32	0.59	730.0	1.09	1.14	1.12
740.0	3.68	3.60	0.08	23.09	0.54	740.0	1.08	1.14	1.12
750.0	3.67	3.61	0.07	22.79	0.58	750.0	1.07	1.13	1.11

¹ Total Loss = Insertion Loss+ 3dB Splitter Loss

2 Way-0° Power Splitter/Combiner

ZFSC-2-1W+

Typical Performance Curves

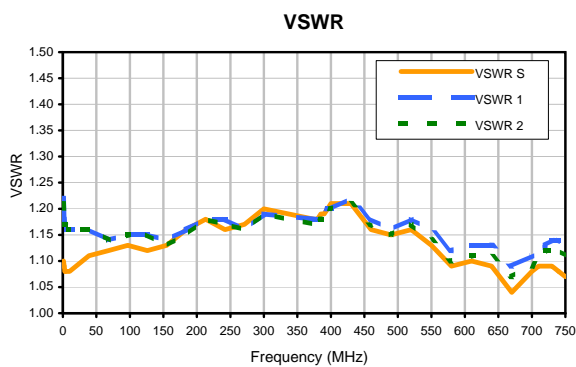
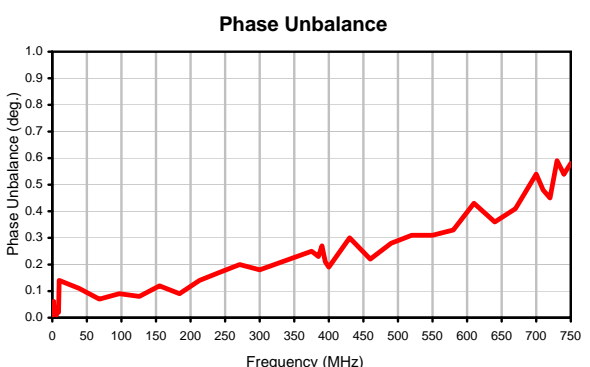
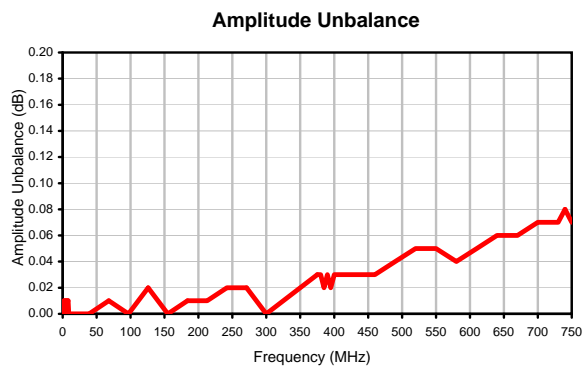
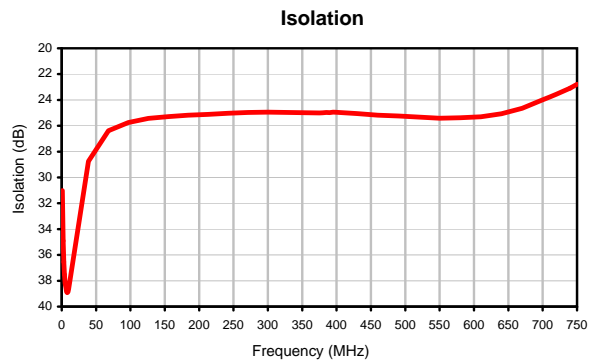
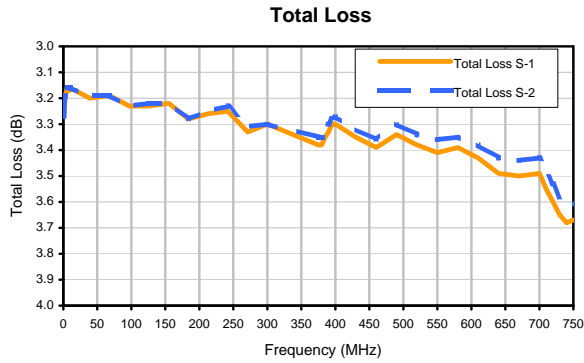

REV. X2
ZFSC-2-1W+
100627
Page 1 of 1

Case Style

K

K18

Outline Dimensions



CASE#	A	B	C	D	E	F	G	H	J	K	L	M	N
K18	1.25 (31.75)	1.25 (31.75)	.75 (19.05)	.63 (16.00)	.38 (9.65)	1.000 (25.40)	.125 (3.18)	1.000 (25.40)	--	--	.125 (3.18)	1.688 (42.88)	2.18 (55.37)

CASE#	P	Q	WT. GRAMS
K18	.75 (19.05)	.07 (1.78)	70.0

Dimensions are in inches (mm). Tolerances: 2 Pl. $\pm .03$; 3 Pl. $\pm .015$

Notes:

- Case material: Aluminum alloy.
- Case finish:
For RoHS Case Styles: Clear chemical conversion coating, non-chrome or trivalent chrome based.
- Mounting bracket available on request. Add suffix B to part number.
- For port marking 1, 2, and 3 see specifications data sheet.
- For bracket version, option B, dimension "C" changes from .75 to .94 inches when connectors are type N.
- Refer to the individual model data sheet for the type of connectors available.

Mini-Circuits®

INTERNET <http://www.minicircuits.com>

P.O. Box 350166, Brooklyn, New York 11235-0003 (718) 934-4500 Fax (718) 332-4661

Distribution Centers NORTH AMERICA 800-654-7949 • 417-335-5935 • Fax 417-335-5945 • EUROPE 44-1252-832600 • Fax 44-1252-837010

Mini-Circuits ISO 9001 & ISO 14001 Certified



All Mini-Circuits products are manufactured under exacting quality assurance and control standards, and are capable of meeting published specifications after being subjected to any or all of the following physical and environmental test.

Specification	Test/Inspection Condition	Reference/Spec
Operating Temperature	-55° to 100°C Ambient Environment	Individual Model Data Sheet
Storage Temperature	-55° to 100° C Ambient Environment	Individual Model Data Sheet
Barometric Pressure	100,000 Feet	MIL-STD-202, Method 105, Condition D
Humidity	90% RH, 65°C Units may require bake-out after humidity to restore full performance.	MIL-STD-202, Method 103
Thermal Shock	-65° to 125°C, 5 cycles	MIL-STD-202, Method 107, Condition B
Vibration (High Frequency)	20g peak, 10-2000 Hz, 12 times in each of three perpendicular directions (total 36)	MIL-STD-202, Method 204, Condition D
Mechanical Shock	100g, 6ms sawtooth, 3 shocks each direction 3 axes (total 18)	MIL-STD-202, Method 213, Condition I