

Coaxial Frequency Mixer

Level 10 (LO Power +10 dBm) 10 to 3000 MHz

ZFM-15+ ZFM-15



Generic photo used for illustration purposes only

CASE STYLE: K18

Connectors	Model
BNC	ZFM-15(+)
SMA	ZFM-15-S+
BRACKET (OPTION "B")	

+RoHS Compliant

The +Suffix identifies RoHS Compliance. See our web site for RoHS Compliance methodologies and qualifications

Maximum Ratings

Operating Temperature	-55°C to 100°C
Storage Temperature	-55°C to 100°C
RF Power	50mW
IF Current	40mA

Permanent damage may occur if any of these limits are exceeded.

Coaxial Connections

LO	1
RF	2
IF	3

Features

- low conversion loss, 6.13 dB typ.
- good L-R isolation, 35 dB typ, L-I, 30 dB typ.
- wideband, 10 to 3000 MHz
- rugged shielded case

Applications

- cellular
- GPS
- MMDS
- ISM
- instrumentation

Outline Drawing

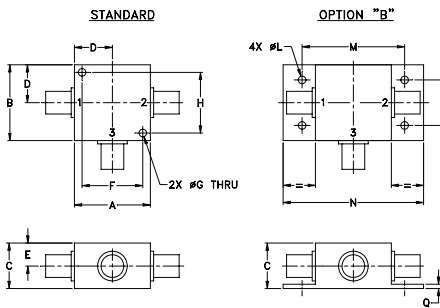

Outline Dimensions (inch/mm)

A	B	C	D	E	F	G	H	
1.25	1.25	.75	.63	.38	1.00	.125	1.000	
31.75	31.75	19.05	16.00	9.65	25.40	3.18	25.40	
J	K	L	M	N	P	Q	wt	
--	--	.125	1.688	2.18	.75	.07	grams	
--	--	3.18	42.88	55.37	19.05	1.78	70.0	

Electrical Specifications

FREQUENCY (MHz)		CONVERSION LOSS (dB)				LO-RF ISOLATION (dB)						LO-IF ISOLATION (dB)					
LO/RF f_L-f_U	IF	Mid-Band		Total Range	Max.	L		M		U		L		M		U	
		\bar{X}	σ			Typ.	Min.	Typ.	Min.	Typ.	Min.	Typ.	Min.	Typ.	Min.	Typ.	Min.
10-3000	10-800	6.13	0.14	8.0	8.5	35	25	35	25	35	25	30	20	30	20	30	20

1 dB COMP.: +5 dBm typ.

L = low range [f_L to $10 f_L$] M = mid range [$10 f_L$ to $f_U/2$] U = upper range [$f_U/2$ to f_U]
m = mid band [$2f_L$ to $f_U/2$]

Typical Performance Data

Frequency (MHz)		Conversion Loss (dB)	Isolation L-R (dB)	Isolation L-I (dB)	VSWR RF Port (:1)	VSWR LO Port (:1)
RF	LO	LO +10dBm	LO +10dBm	LO +10dBm	LO +10dBm	LO +10dBm
10.00	40.00	6.53	26.10	25.08	1.84	1.71
20.00	50.00	6.60	30.38	29.74	1.54	1.51
100.00	70.00	6.55	35.82	35.93	1.50	1.37
200.00	170.00	6.60	37.35	38.21	1.55	1.44
400.00	370.00	6.74	36.49	39.50	1.72	1.40
500.00	470.00	6.52	35.42	38.00	1.99	1.34
790.00	760.00	6.70	32.94	33.60	2.45	1.33
920.00	890.00	6.76	32.80	33.97	2.70	1.36
1180.00	1150.00	7.30	31.62	32.89	2.85	1.36
1310.00	1280.00	7.30	31.27	34.31	2.75	1.38
1500.00	1470.00	6.54	29.76	32.85	2.28	1.30
1700.00	1670.00	6.91	28.49	30.87	1.94	1.27
1830.00	1800.00	6.97	29.46	28.22	1.44	1.29
2000.00	1970.00	7.07	28.32	27.77	1.25	1.34
2200.00	2170.00	6.97	27.89	27.68	1.42	1.34
2480.00	2450.00	6.93	28.37	24.64	1.97	1.44
2610.00	2580.00	7.08	27.10	23.13	2.18	1.52
2740.00	2710.00	7.45	26.79	21.95	2.37	1.93
2870.00	2840.00	7.56	26.23	21.25	2.09	2.25
3000.00	2970.00	8.31	29.30	20.32	2.18	2.63

Electrical Schematic

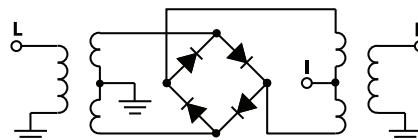

Notes

- Performance and quality attributes and conditions not expressly stated in this specification document are intended to be excluded and do not form a part of this specification document.
- Electrical specifications and performance data contained in this specification document are based on Mini-Circuit's applicable established test performance criteria and measurement instructions.
- The parts covered by this specification document are subject to Mini-Circuits standard limited warranty and terms and conditions (collectively, "Standard Terms"); Purchasers of this part are entitled to the rights and benefits contained therein. For a full statement of the Standard Terms and the exclusive rights and remedies thereunder, please visit Mini-Circuits' website at www.minicircuits.com/MCLStore/terms.jsp

Mini-Circuits

www.minicircuits.com P.O. Box 350166, Brooklyn, NY 11235-0003 (718) 934-4500 sales@minicircuits.com

REV. C
M151107
ZFM-15
DJ/TD/CP
200428
Page 1 of 2

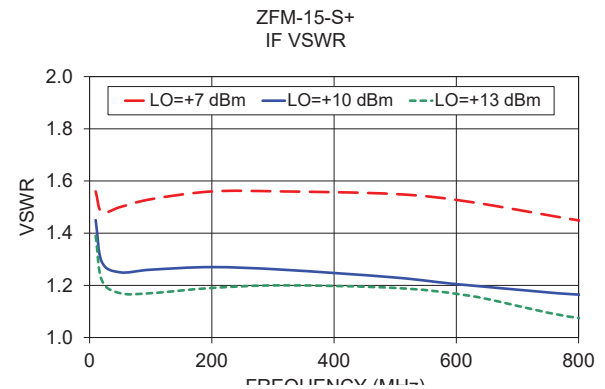
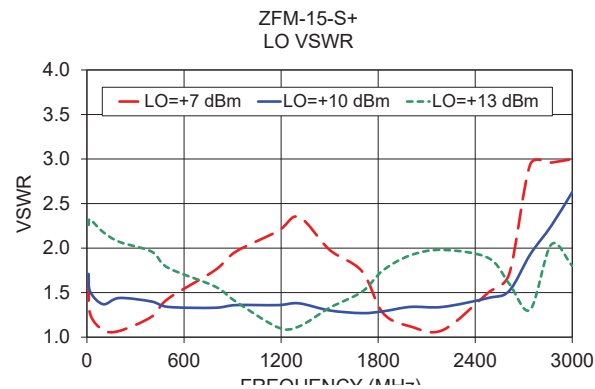
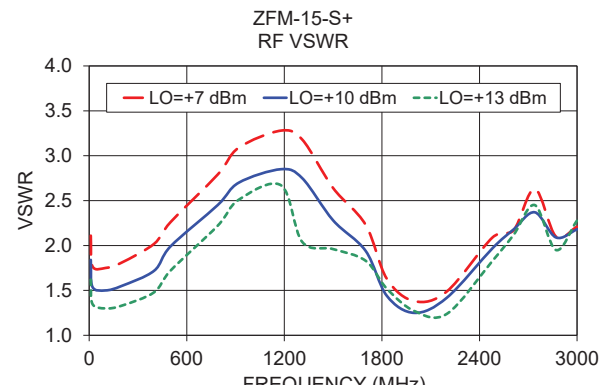
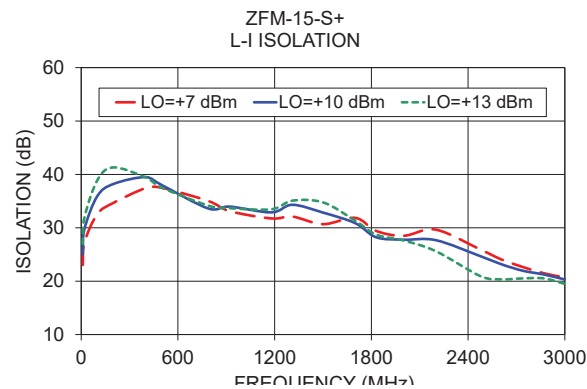
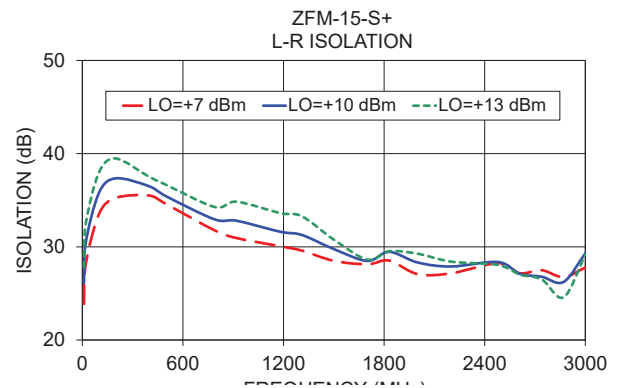
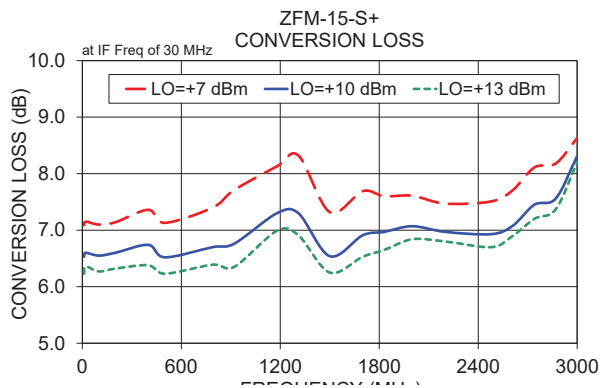

Notes

- A. Performance and quality attributes and conditions not expressly stated in this specification document are intended to be excluded and do not form a part of this specification document.
- B. Electrical specifications and performance data contained in this specification document are based on Mini-Circuit's applicable established test performance criteria and measurement instructions.
- C. The parts covered by this specification document are subject to Mini-Circuits standard limited warranty and terms and conditions (collectively, "Standard Terms"); Purchasers of this part are entitled to the rights and benefits contained therein. For a full statement of the Standard Terms and the exclusive rights and remedies thereunder, please visit Mini-Circuits' website at www.minicircuits.com/MCLStore/terms.jsp



Frequency Mixer

ZFM-15+

Typical Performance Data

RF (MHz)	LO (MHz)	CONVERSION LOSS (dB)			LO (MHz)	LO-RF ISOLATION (dB)			LO-IF ISOLATION (dB)		
		@LO (dBm)				@LO (dBm)			@LO (dBm)		
		+7	+10	+13		+7	+10	+13	+7	+10	+13
10.0	40.0	7.09	6.53	6.23	10.0	23.88	26.10	27.81	23.04	25.08	27.01
20.0	50.0	7.15	6.60	6.36	20.0	28.07	30.38	32.40	27.25	29.74	31.89
100.0	70.0	7.10	6.55	6.27	100.0	33.54	35.82	38.01	32.56	35.93	38.89
200.0	170.0	7.14	6.60	6.32	200.0	35.25	37.35	39.48	34.67	38.21	41.31
400.0	370.0	7.36	6.74	6.38	400.0	35.50	36.49	37.50	37.43	39.50	39.44
500.0	470.0	7.13	6.52	6.23	500.0	34.59	35.42	36.65	37.49	38.00	37.53
790.0	760.0	7.40	6.70	6.39	790.0	31.76	32.94	34.27	35.00	33.60	34.14
920.0	890.0	7.71	6.76	6.35	920.0	30.94	32.80	34.84	33.13	33.97	33.68
1180.0	1150.0	8.13	7.30	6.99	1180.0	30.06	31.62	33.62	31.75	32.89	33.47
1310.0	1280.0	8.32	7.30	6.91	1310.0	29.59	31.27	33.27	32.10	34.31	35.08
1500.0	1470.0	7.32	6.54	6.25	1500.0	28.50	29.76	30.77	30.68	32.85	34.76
1700.0	1670.0	7.69	6.91	6.53	1700.0	28.13	28.49	28.63	31.86	30.87	31.34
1830.0	1800.0	7.60	6.97	6.65	1830.0	28.52	29.46	29.52	29.41	28.22	28.72
2000.0	1970.0	7.61	7.07	6.84	2000.0	27.07	28.32	29.26	28.50	27.77	27.62
2200.0	2170.0	7.47	6.97	6.80	2200.0	27.16	27.89	28.41	29.65	27.68	25.61
2480.0	2450.0	7.51	6.93	6.70	2480.0	28.24	28.37	28.05	25.87	24.64	20.89
2610.0	2580.0	7.71	7.08	6.90	2610.0	27.17	27.10	27.02	24.02	23.13	20.35
2740.0	2710.0	8.11	7.45	7.20	2740.0	27.49	26.79	26.50	22.65	21.95	20.52
2870.0	2840.0	8.18	7.56	7.37	2870.0	26.75	26.23	24.58	21.48	21.25	20.52
3000.0	2970.0	8.63	8.31	8.20	3000.0	27.78	29.30	29.14	20.68	20.32	19.50



Frequency Mixer

ZFM-15+

Typical Performance Data

RF/LO (MHz)	RF VSWR (:1)			LO VSWR (:1)			IF (MHz)	IF VSWR (:1)			LO/RF (MHz)	max. DC output (mV)	DC Offset (mV)
	@LO (dBm)			@LO (dBm)				@LO (dBm)			@LO (dBm)		
	+7	+10	+13	+7	+10	+13		+7	+10	+13	+10		
10.0	2.11	1.84	1.62	1.62	1.71	2.26	10.0	1.56	1.45	1.39	10.00	216.1	-2.26
20.0	1.77	1.54	1.35	1.26	1.51	2.32	20.0	1.48	1.29	1.22	20.00	216.7	-0.18
50.0	1.75	1.50	1.30	1.08	1.37	2.18	50.0	1.50	1.25	1.17	50.00	217.1	0.25
100.0	1.81	1.55	1.33	1.07	1.44	2.07	100.0	1.53	1.26	1.17	100.00	214.7	0.40
200.0	2.02	1.72	1.48	1.23	1.40	1.96	200.0	1.56	1.27	1.19	200.00	219.0	0.57
316.2	2.26	1.99	1.72	1.43	1.34	1.78	316.2	1.56	1.26	1.20	324.69	232.8	0.80
500.0	2.79	2.45	2.22	1.75	1.33	1.57	500.0	1.55	1.23	1.19	414.60	206.4	1.02
622.3	3.09	2.70	2.51	1.96	1.36	1.40	622.3	1.52	1.20	1.16	500.00	192.5	0.93
851.9	3.28	2.85	2.67	2.19	1.36	1.11	851.9	1.43	1.16	1.07	639.37	223.8	1.05
1000.0	3.18	2.75	2.04	2.35	1.38	1.12	1000.0	1.40	1.20	1.24	729.28	205.6	1.39
1200.0	2.64	2.28	1.96	1.98	1.30	1.33	1200.0	1.48	1.37	1.14	800.00	179.6	1.40
1311.1	2.23	1.94	1.83	1.74	1.27	1.51	1311.1	1.58	1.48	1.04	909.10	183.2	1.28
1500.0	1.63	1.44	1.52	1.27	1.29	1.75	1500.0	1.74	1.56	1.19	1000.00	190.3	1.27
1617.3	1.38	1.25	1.27	1.12	1.34	1.92	1617.3	1.76	1.52	1.37	1200.00	196.4	1.71
1770.4	1.49	1.42	1.24	1.08	1.34	1.98	1770.4	1.59	1.31	1.62	1500.00	178.7	3.01
2000.0	2.09	1.97	1.83	1.50	1.44	1.89	2000.0	1.34	1.14	1.87	1800.00	175.8	2.71
2200.0	2.17	2.18	2.12	1.71	1.52	1.60	2200.0	1.37	1.30	1.80	2000.00	195.0	1.08
2500.0	2.63	2.37	2.45	2.94	1.93	1.31	2500.0	2.37	2.66	1.72	2200.00	171.8	-0.67
2800.0	2.10	2.09	1.95	2.96	2.25	2.04	2800.0	3.68	3.79	3.80	2500.00	177.3	-2.90
3000.0	2.21	2.18	2.28	3.00	2.63	1.80	3000.0	3.82	4.88	3.98	2800.00	163.2	-5.28
											3000.00	180.1	-6.79

REV. X1
ZFM-15+
060614
Page 2 of 2



IF/RF MICROWAVE COMPONENTS • ISO 9001 ISO 14001 AS 9100 CERTIFIED RoHS compliant
P.O. Box 350166, Brooklyn, New York 11235-0003 (718) 934-4500 Fax (718) 332-4661



The Design Engineers Search Engine finds the model you need, Instantly • For detailed performance specs & shopping online see



Typical Performance Curves

Conversion Loss

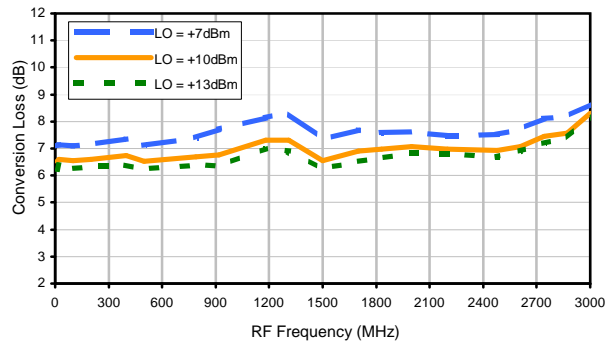

LO-RF Isolation

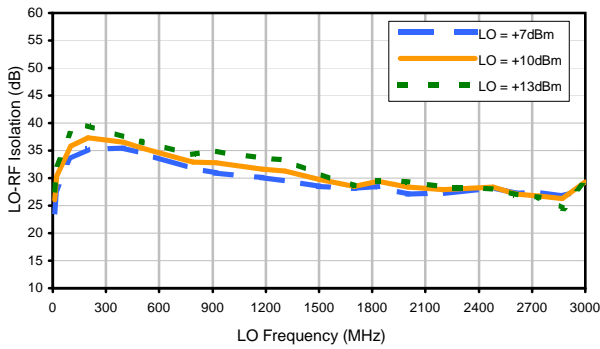

LO-IF Isolation

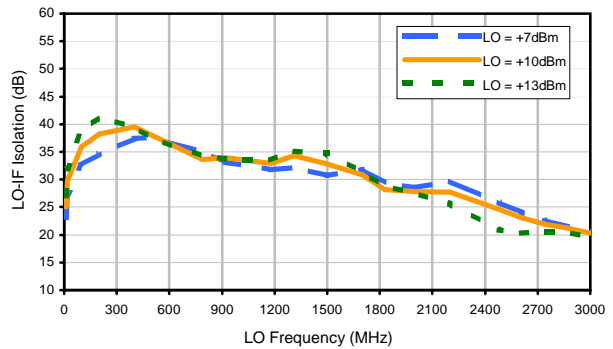

RF VSWR

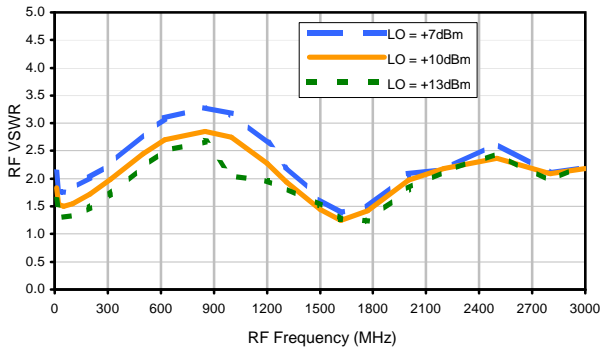

LO VSWR

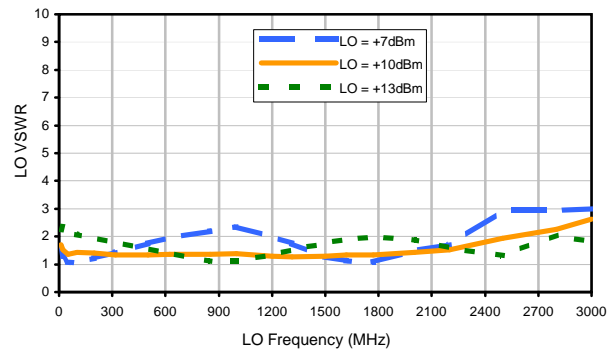

IF VSWR

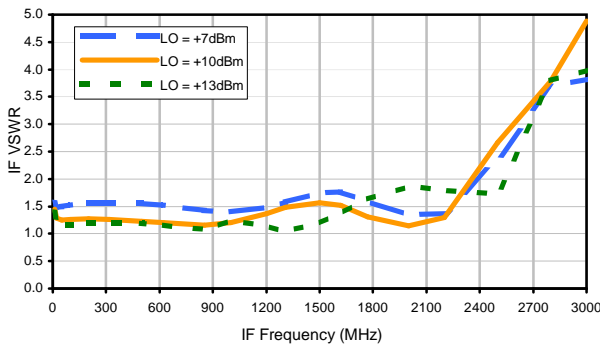

Max. DC Output

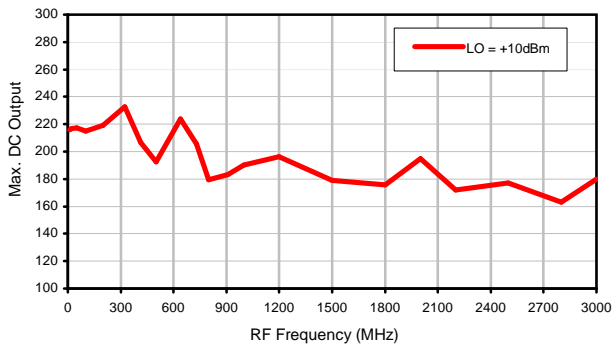

Case Style

K

K18

Outline Dimensions

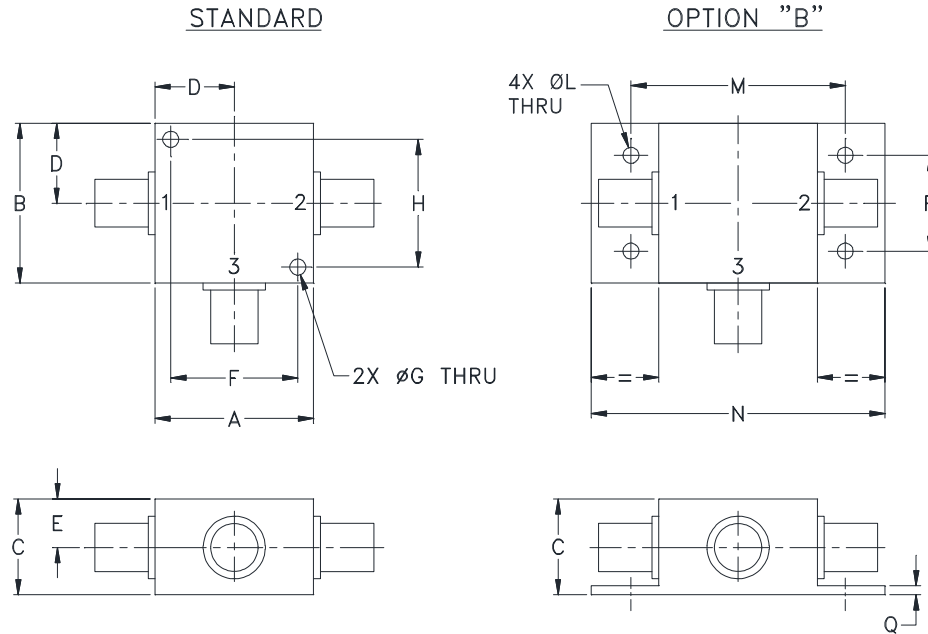

CASE#	A	B	C	D	E	F	G	H	J	K	L	M	N
K18	1.25 (31.75)	1.25 (31.75)	.75 (19.05)	.63 (16.00)	.38 (9.65)	1.000 (25.40)	.125 (3.18)	1.000 (25.40)	--	--	.125 (3.18)	1.688 (42.88)	2.18 (55.37)

CASE#	P	Q	WT. GRAMS
K18	.75 (19.05)	.07 (1.78)	70.0

Dimensions are in inches (mm). Tolerances: 2 Pl. $\pm .03$; 3 Pl. $\pm .015$

Notes:

- Case material: Aluminum alloy.
- Case finish:
For RoHS Case Styles: Clear chemical conversion coating, non-chrome or trivalent chrome based.
- Mounting bracket available on request. Add suffix B to part number.
- For port marking 1, 2, and 3 see specifications data sheet.
- For bracket version, option B, dimension "C" changes from .75 to .94 inches when connectors are type N.
- Refer to the individual model data sheet for the type of connectors available.

Mini-Circuits®

INTERNET <http://www.minicircuits.com>

P.O. Box 350166, Brooklyn, New York 11235-0003 (718) 934-4500 Fax (718) 332-4661

Distribution Centers NORTH AMERICA 800-654-7949 • 417-335-5935 • Fax 417-335-5945 • EUROPE 44-1252-832600 • Fax 44-1252-837010

Mini-Circuits ISO 9001 & ISO 14001 Certified



All Mini-Circuits products are manufactured under exacting quality assurance and control standards, and are capable of meeting published specifications after being subjected to any or all of the following physical and environmental test.

Specification	Test/Inspection Condition	Reference/Spec
Operating Temperature	-55° to 100°C Ambient Environment	Individual Model Data Sheet
Storage Temperature	-55° to 100° C Ambient Environment	Individual Model Data Sheet
Barometric Pressure	100,000 Feet	MIL-STD-202, Method 105, Condition D
Humidity	90% RH, 65°C Units may require bake-out after humidity to restore full performance.	MIL-STD-202, Method 103
Thermal Shock	-65° to 125°C, 5 cycles	MIL-STD-202, Method 107, Condition B
Vibration (High Frequency)	20g peak, 10-2000 Hz, 12 times in each of three perpendicular directions (total 36)	MIL-STD-202, Method 204, Condition D
Mechanical Shock	100g, 6ms sawtooth, 3 shocks each direction 3 axes (total 18)	MIL-STD-202, Method 213, Condition I