

# Coaxial Broadband Amplifier

## ZFL-1200G+

50Ω Variable Gain 10 to 1200 MHz

### Features

- wideband, 10 to 1200 MHz
- rugged, shielded case
- gain control range: 60 dB typ.
- gain control voltage: 0 to +5V
- variable gain: -35 dB to +27

### Applications

- cellular
- VHF/UHF
- AGC applications



Generic photo used for illustration purposes only

CASE STYLE: Y39

Connectors Model  
**SMA** ZFL-1200G+  
**BRACKET (OPTION "B")**

### +RoHS Compliant

The +Suffix identifies RoHS Compliance. See our web site for RoHS Compliance methodologies and qualifications

### Electrical Specifications at 25°C, $V_{CTRL}=0V$ (or open)

Parameter	Condition (MHz)	Min.	Typ.	Max.	Units
Frequency Range		10	—	1200	MHz
Gain	10-1200	23	27	—	dB
Gain Flatness	10-1200	—	±1.0	—	dB
Output Power at 1dB compression	10-1200	—	+8	—	dBm
Output power at 3 dB compression	10-1200	—	+10	—	dBm
Noise Figure	10-1200	—	6.5	—	dB
Output third order intercept point	10-1200	—	+22	—	dBm
Output second order intercept point	10-1200	—	+40	—	dBm
Input VSWR	10-1200	—	1.25	—	:1
Output VSWR	10-1200	—	1.5	—	:1
DC Supply Voltage		—	15	—	V
Supply Current		—	—	180	mA

Open load is not recommended, potentially can cause damage.  
 With no load derate max input power by 20 dB

$V_{CTRL}$ : Gain Control Voltage.

### Outline Drawing

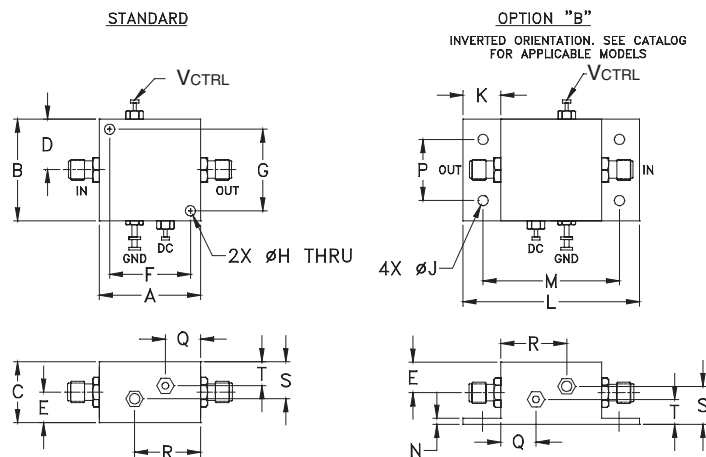

### Gain Flatness, $V_{CC}=15V$ , 10-1200 MHz

$V_{CTRL}$ (V)	Gain Flatness (dB) Typ.
0 or open	±1.0
1	±1.3
2	±1.9
3	±3.2
4	±1.2
5	±1.3

### Maximum Ratings

Parameter	Ratings
Operating Temperature	-20°C to 71°C
Storage Temperature	-55°C to 100°C
DC Voltage	+17V
$V_{CTRL}$	0 to +5.5V
Input RF Power (no damage)	+10 dBm

Permanent damage may occur if any of these limits are exceeded.

### Outline Dimensions (inch/mm)

A	B	C	D	E	F	G	H	J	K	L	M	N	P	Q	R	S	T	wt.
1.25	1.25	.75	.63	.36	1.000	1.000	.125	.125	.46	2.18	1.688	.06	.750	.50	.80	.45	.29	grams
31.75	31.75	19.05	16.00	9.14	25.40	25.40	3.18	3.18	11.68	55.37	42.88	1.52	19.05	12.70	20.32	11.43	7.37	38

### Notes

- Performance and quality attributes and conditions not expressly stated in this specification document are intended to be excluded and do not form a part of this specification document.
- Electrical specifications and performance data contained in this specification document are based on Mini-Circuit's applicable established test performance criteria and measurement instructions.
- The parts covered by this specification document are subject to Mini-Circuits standard limited warranty and terms and conditions (collectively, "Standard Terms"); Purchasers of this part are entitled to the rights and benefits contained therein. For a full statement of the Standard Terms and the exclusive rights and remedies thereunder, please visit Mini-Circuits' website at [www.minicircuits.com/MCLStore/terms.jsp](http://www.minicircuits.com/MCLStore/terms.jsp)



FREQUENCY (MHz)	GAIN (dB)	DIRECTIVITY (dB)	VSWR (:1)		POUT at 1 dB COMPR. (dBm)	POUT at 3 dB COMPR. (dBm)	NOISE FIGURE (dB)	IP3 (dBm)	IP2 (dBm)
			IN	OUT					
10.00	27.09	20.17	1.20	1.29	9.60	11.21	10.85	21.92	46.48
50.00	27.37	29.38	1.18	1.15	9.60	10.95	8.12	22.99	41.81
100.00	27.34	43.55	1.17	1.19	10.60	12.00	6.21	24.61	42.79
200.00	27.17	41.29	1.17	1.28	10.85	12.26	5.93	24.50	44.28
300.00	27.04	38.39	1.18	1.44	11.08	12.38	5.94	24.77	46.68
400.00	26.84	45.31	1.19	1.57	11.48	12.44	5.96	24.82	43.69
500.00	26.72	56.49	1.20	1.64	11.17	11.99	6.56	23.66	39.78
600.00	26.59	48.17	1.22	1.71	11.46	12.16	6.38	23.27	39.47
700.00	26.48	41.28	1.23	1.73	11.14	11.87	6.50	22.28	38.26
800.00	26.32	40.07	1.25	1.71	11.00	11.73	6.46	21.34	37.49
900.00	26.19	43.02	1.27	1.68	10.64	11.38	6.72	20.32	36.84
1000.00	25.99	43.26	1.29	1.60	10.26	10.95	6.60	18.95	34.79
1100.00	25.83	52.98	1.31	1.55	10.03	10.73	6.78	18.15	35.23
1200.00	25.55	45.07	1.34	1.47	9.72	10.40	7.15	17.12	35.19

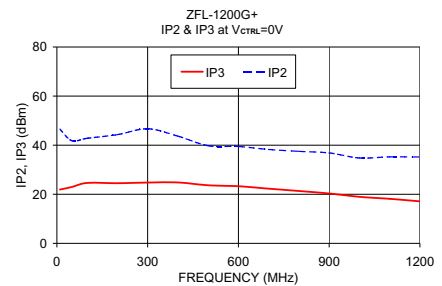
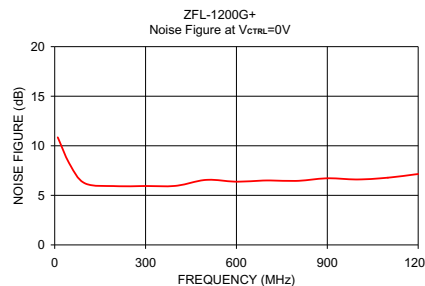
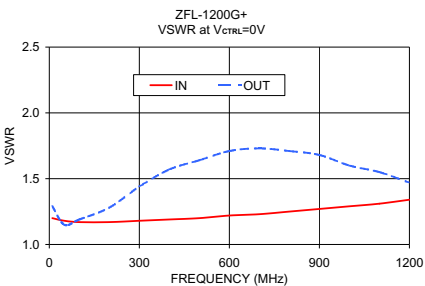
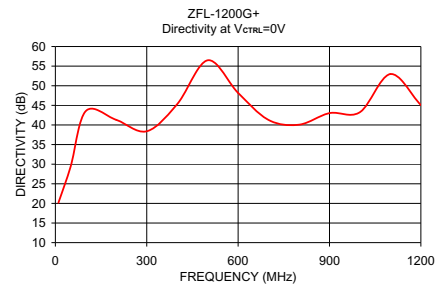
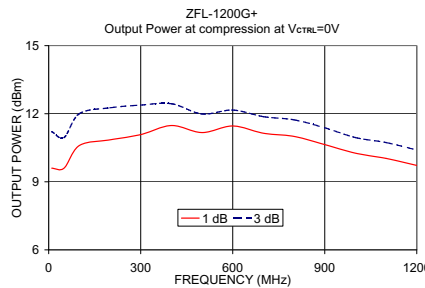
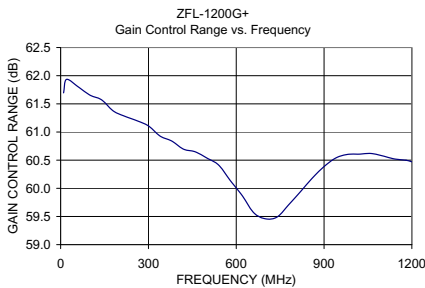
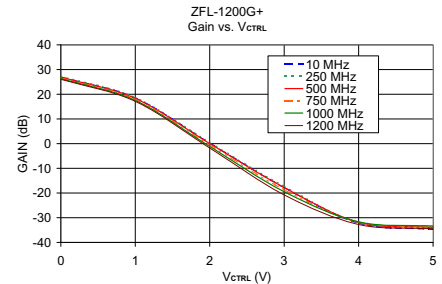
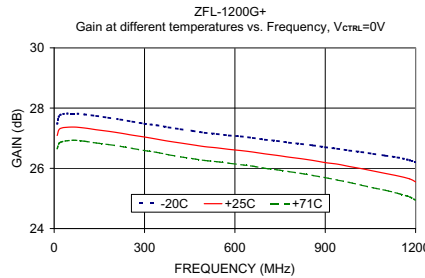
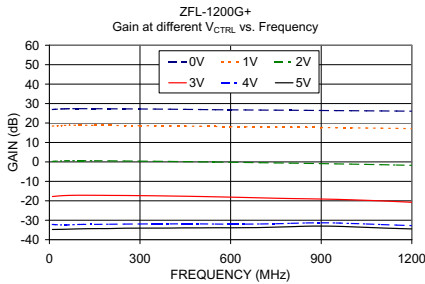

Notes

- A. Performance and quality attributes and conditions not expressly stated in this specification document are intended to be excluded and do not form a part of this specification document.
- B. Electrical specifications and performance data contained in this specification document are based on Mini-Circuit's applicable established test performance criteria and measurement instructions.
- C. The parts covered by this specification document are subject to Mini-Circuits standard limited warranty and terms and conditions (collectively, "Standard Terms"); Purchasers of this part are entitled to the rights and benefits contained therein. For a full statement of the Standard Terms and the exclusive rights and remedies thereunder, please visit Mini-Circuits' website at [www.minicircuits.com/MCLStore/terms.jsp](http://www.minicircuits.com/MCLStore/terms.jsp)



# Broadband Amplifier

# ZFL-1200G+

## Typical Performance Data

Vctrl=0V @ 25°C									
FREQUENCY (MHz)	GAIN (dB) 15V	DIRECTIVITY (dB) 15V	VSWR IN (:1) 15V	VSWR OUT (:1) 15V	NOISE FIGURE (dB) 15V	Pout at 1dB Comp. (dBm) 15V	Pout at 3dB Comp. (dBm) 15V	Output IP2 (dBm) 15V	Output IP3 (dBm) 15V
10.0	26.94	20.17	1.20	1.29	10.85	9.60	11.21	46.48	21.92
50.0	27.30	29.38	1.18	1.15	8.12	9.60	10.95	41.81	22.99
100.0	27.38	43.55	1.17	1.19	6.21	10.60	12.00	42.79	24.61
200.0	27.31	41.29	1.17	1.33	5.93	10.85	12.26	44.28	24.50
300.0	27.23	38.39	1.18	1.44	5.94	11.08	12.38	46.68	24.77
400.0	27.10	50.36	1.19	1.57	5.96	11.48	12.44	43.69	24.82
500.0	26.93	56.49	1.20	1.64	6.56	11.17	11.99	39.78	23.66
600.0	26.78	48.17	1.22	1.71	6.38	11.46	12.16	39.47	23.27
700.0	26.66	41.28	1.23	1.73	6.50	11.14	11.87	38.26	22.28
800.0	26.56	45.20	1.25	1.71	6.46	11.00	11.73	37.49	21.34
900.0	26.45	43.02	1.27	1.68	6.72	10.64	11.38	36.84	20.32
1000.0	26.34	43.26	1.28	1.63	6.60	10.26	10.95	34.79	18.95
1100.0	26.21	46.52	1.31	1.55	6.78	10.03	10.73	35.23	18.15
1200.0	26.08	45.07	1.34	1.47	7.15	9.72	10.40	35.19	17.12



P.O. Box 350166, Brooklyn, New York 11235-0003 (718) 934-4500 • Fax (718) 332-4661 For detailed performance specs & shopping online see Mini-Circuits web site [www.minicircuits.com](http://www.minicircuits.com)



The Design Engineers Search Engine Provides ACTUAL Data Instantly From MINI-CIRCUITS At: [www.minicircuits.com](http://www.minicircuits.com)

IF/RF MICROWAVE COMPONENTS

# Broadband Amplifier

# ZFL-1200G+

## Typical Performance Data

FREQUENCY (MHz)	GAIN @ Vdc=15V & 25°C						FREQUENCY (MHz)	GAIN CONTROL RANGE @ Vdc=15V & 25°C (dB)	FREQUENCY (MHz)	GAIN @ Vdc=15V & Vctrl=0V		
	Vctrl (V) = 0	Vctrl (V) = 1	Vctrl (V) = 2	Vctrl (V) = 3	Vctrl (V) = 4	Vctrl (V) = 5				-20°C	+25°C	+71°C
10.0	26.94	18.45	0.24	-17.79	-32.18	-34.75	10.0	61.70	10.0	27.48	27.09	26.65
50.0	27.30	18.77	0.55	-17.31	-32.45	-34.64	50.0	61.93	60.0	27.82	27.37	26.93
100.0	27.38	18.84	0.65	-17.15	-32.17	-34.42	100.0	61.80	100.0	27.79	27.34	26.90
150.0	27.35	18.80	0.60	-17.17	-32.12	-34.31	150.0	61.66	140.0	27.74	27.28	26.84
200.0	27.31	18.75	0.54	-17.22	-32.06	-34.26	200.0	61.57	180.0	27.68	27.23	26.79
250.0	27.27	18.69	0.47	-17.27	-31.97	-34.10	250.0	61.37	220.0	27.62	27.17	26.73
300.0	27.23	18.62	0.40	-17.35	-31.92	-34.05	300.0	61.28	260.0	27.55	27.10	26.66
350.0	27.17	18.56	0.32	-17.43	-31.89	-34.04	350.0	61.20	300.0	27.48	27.04	26.59
400.0	27.10	18.48	0.23	-17.54	-31.88	-34.01	400.0	61.11	420.0	27.30	26.84	26.38
450.0	27.01	18.39	0.13	-17.65	-31.87	-33.92	450.0	60.93	500.0	27.18	26.72	26.26
500.0	26.93	18.31	0.04	-17.79	-31.88	-33.91	500.0	60.84	620.0	27.06	26.59	26.12
550.0	26.84	18.22	-0.07	-17.95	-31.95	-33.85	550.0	60.70	700.0	26.95	26.48	26.00
600.0	26.78	18.14	-0.18	-18.12	-32.01	-33.87	600.0	60.65	740.0	26.91	26.43	25.95
650.0	26.71	18.07	-0.28	-18.30	-31.99	-33.82	650.0	60.54	780.0	26.85	26.37	25.89
700.0	26.66	18.00	-0.40	-18.49	-31.91	-33.75	700.0	60.41	820.0	26.81	26.32	25.83
750.0	26.61	17.92	-0.52	-18.68	-31.79	-33.53	750.0	60.14	860.0	26.76	26.26	25.76
800.0	26.56	17.84	-0.64	-18.84	-31.58	-33.32	800.0	59.87	900.0	26.70	26.19	25.69
850.0	26.51	17.77	-0.75	-18.95	-31.40	-33.06	850.0	59.57	940.0	26.65	26.14	25.61
900.0	26.45	17.68	-0.88	-19.09	-31.32	-33.01	900.0	59.46	980.0	26.59	26.06	25.53
950.0	26.40	17.59	-1.01	-19.26	-31.41	-33.10	950.0	59.49	1020.0	26.54	25.99	25.44
1000.0	26.34	17.50	-1.14	-19.48	-31.66	-33.38	1000.0	59.71	1060.0	26.48	25.91	25.35
1050.0	26.27	17.41	-1.29	-19.75	-31.93	-33.67	1050.0	59.94	1100.0	26.42	25.83	25.27
1100.0	26.21	17.32	-1.44	-20.06	-32.23	-33.97	1100.0	60.18	1140.0	26.36	25.75	25.17
1150.0	26.15	17.23	-1.60	-20.40	-32.50	-34.24	1150.0	60.39	1180.0	26.27	25.65	25.05
1200.0	26.08	17.13	-1.77	-20.76	-32.75	-34.46	1200.0	60.54	1200.0	26.20	25.55	24.94



P.O. Box 350166, Brooklyn, New York 11235-0003 (718) 934-4500 • Fax (718) 332-4661 For detailed performance specs & shopping online see Mini-Circuits web site  
 The Design Engineers Search Engine Provides ACTUAL Data Instantly From MINI-CIRCUITS At: [www.minicircuits.com](http://www.minicircuits.com)



IF/RF MICROWAVE COMPONENTS

REV. OR  
 ZFL-1200G+  
 5/17/2012  
 Page 2 of 2

## Typical Performance Curves

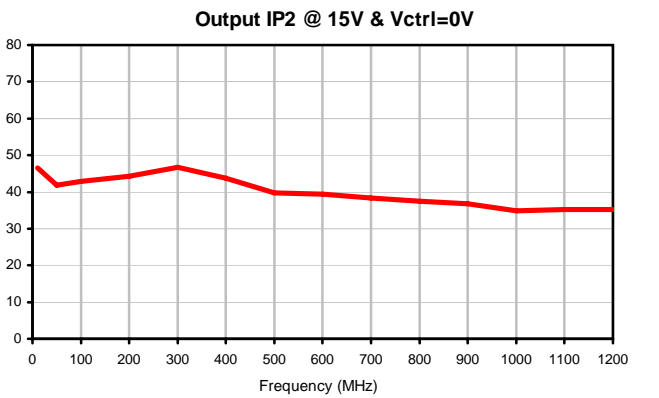
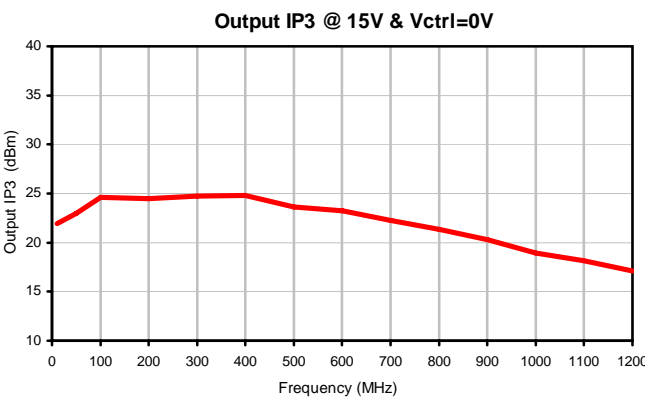
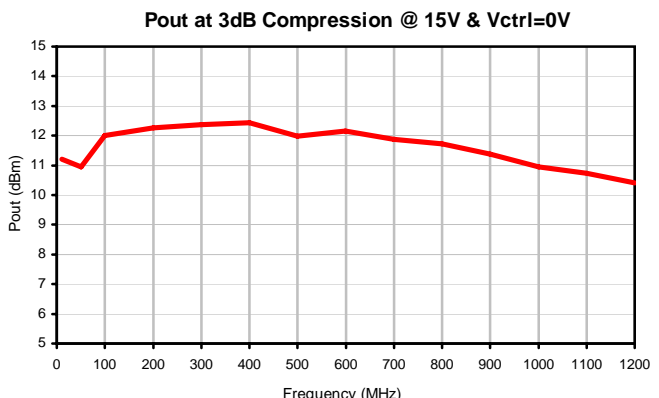
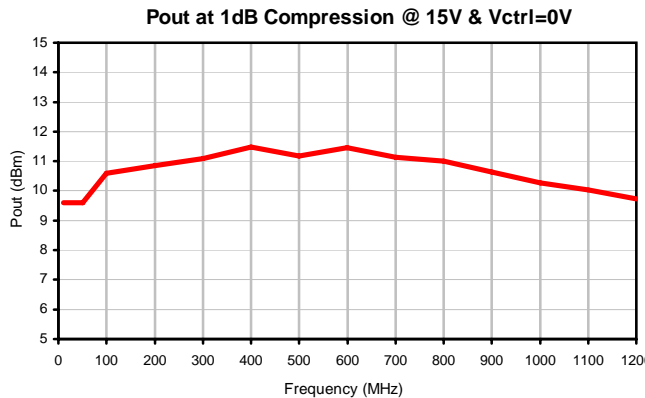
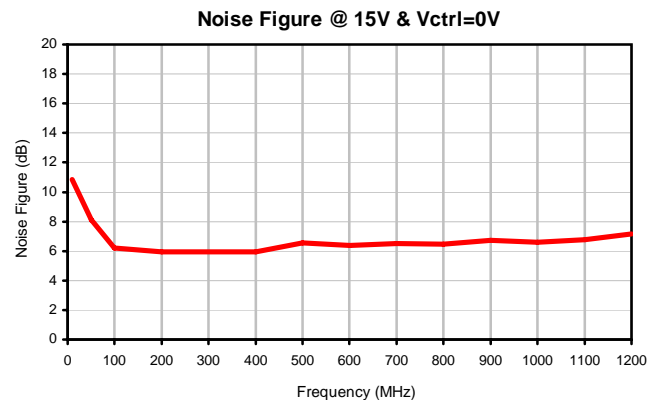
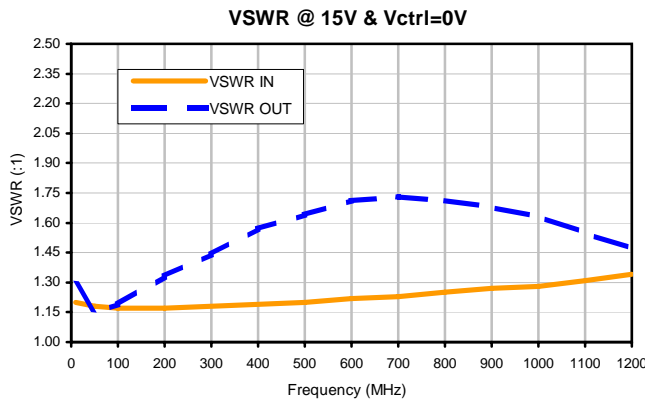
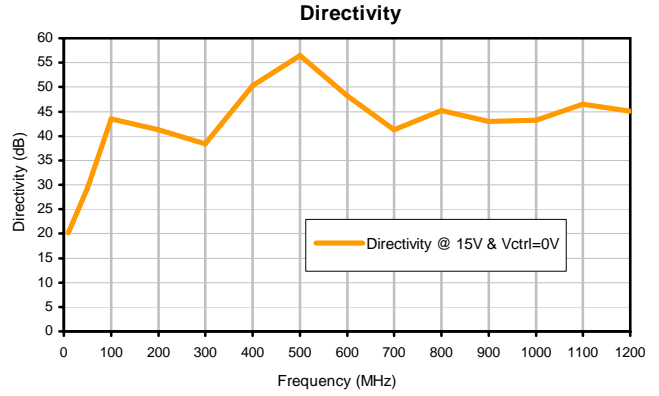
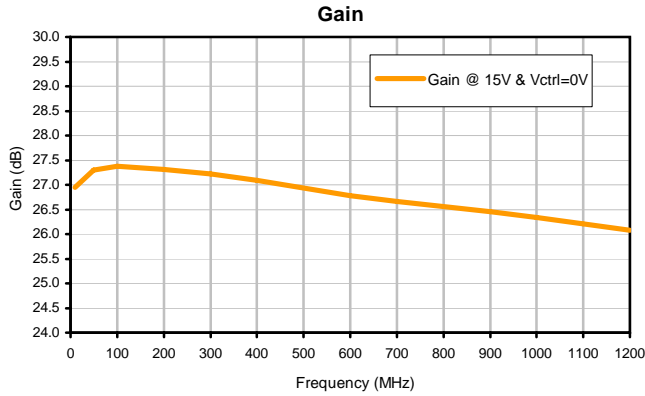

## Typical Performance Curves

Gain vs. Frequency & Different Vctrl @ Vdc=15V

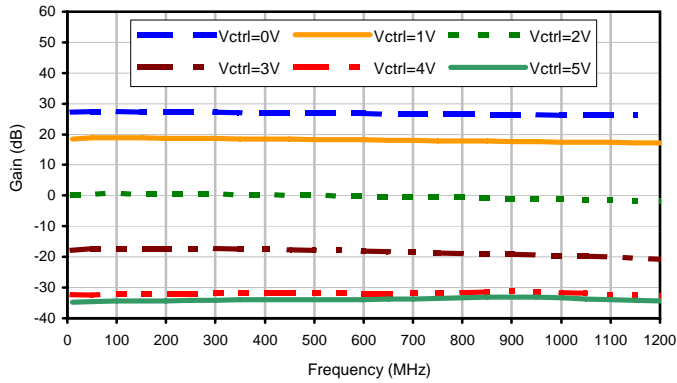

Gain vs Frequency & Temperature @ Vdc=15V & Vctrl=0V

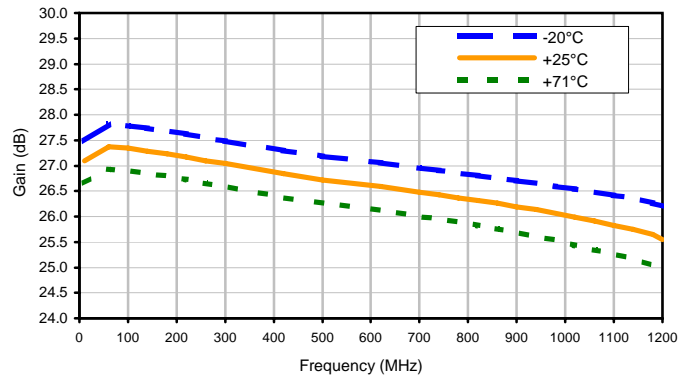

Gain vs. Control Voltage @ Vdc=15V

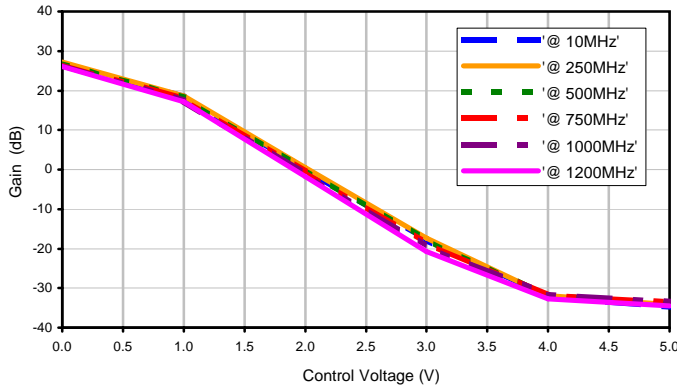

Gain Control Range vs. Frequency @ Vdc=15V

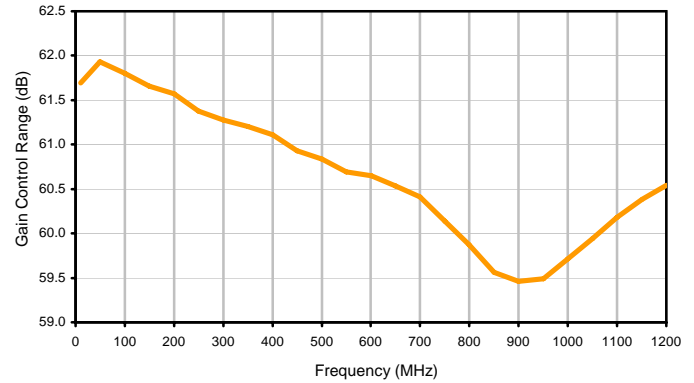

# Case Style

# Y

## Y39

### Outline Dimensions

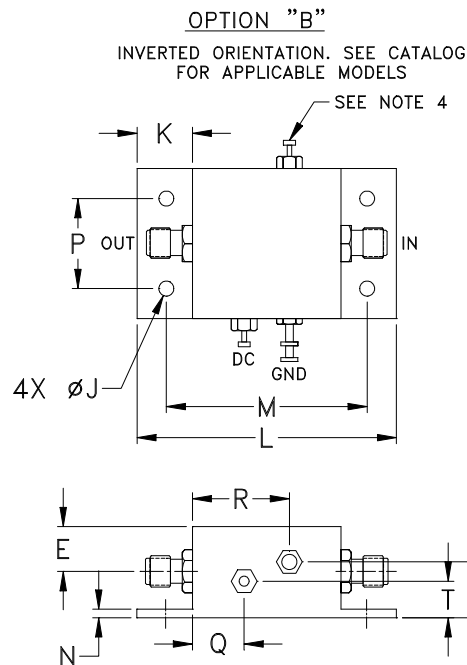
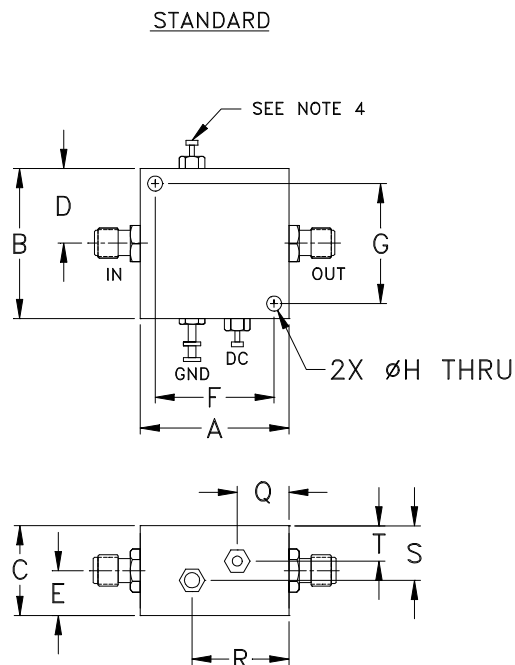

CASE#	A	B	C	D	E	F	G	H	J	K	L	M	N
Y39	1.25 (31.75)	1.25 (31.75)	.75 (19.05)	.63 (16.0)	.36 (9.15)	1.000 (25.4)	1.000 (25.4)	.125 (3.2)	.125 (3.2)	.46 (11.7)	2.18 (55.4)	1.688 (42.9)	.06 (1.5)

CASE#	P	Q	R	S	T	WT. GRAMS
Y39	.750 (19.0)	.50 (12.7)	.80 (20.3)	.45 (11.4)	.29 (7.4)	38

Dimensions are in inches (mm). Tolerances: 2 Pl.  $\pm .03$ ; 3 Pl.  $\pm .015$

#### Notes:

1. Case material: Aluminum alloy.
2. Case finish:  
For RoHS Case Styles: Clear chemical conversion coating, non-chrome or trivalent chrome based.
3. Mounting bracket available on request. Add suffix B to part number
4. Gain terminal may exist on some models, refer catalog data sheet for details..

**Mini-Circuits®**

INTERNET <http://www.minicircuits.com>

P.O. Box 350166, Brooklyn, New York 11235-0003 (718) 934-4500 Fax (718) 332-4661

Distribution Centers NORTH AMERICA 800-654-7949 • 417-335-5935 • Fax 417-335-5945 • EUROPE 44-1252-832600 • Fax 44-1252-837010

Mini-Circuits ISO 9001 & ISO 14001 Certified



All Mini-Circuits products are manufactured under exacting quality assurance and control standards, and are capable of meeting published specifications after being subjected to any or all of the following physical and environmental test.

Specification	Test/Inspection Condition	Reference/Spec
Operating Temperature	-20° to 71° C Ambient Environment	Individual Model Data Sheet
Storage Temperature	-55° to 100° C Ambient Environment	Individual Model Data Sheet
Stabilization Bake	(non-operating) 125°C, 24 hours	- - -
Burn-in at Elevated Temp.	(DC on) 160 hours at 85° C	MIL-STD-202, Method 108
Thermal Shock	-55° to 100°C, 5 cycles	MIL-STD-202, Method 107, Condition A, except 100°C