

Coaxial Directional Coupler

ZFDC-10-5+

50Ω

1 to 2000 MHz

Maximum Ratings

Operating Temperature	-55°C to 100°C
Storage Temperature	-55°C to 100°C

Permanent damage may occur if any of these limits are exceeded.

Coaxial Connections

INPUT	1
OUTPUT	2
COUPLED	3

Features

- very wideband, 1 to 2000 MHz
- excellent directivity, 30 dB typ.
- rugged shielded case

Applications

- cellular
- instrumentation
- communication receivers & transmitters
- GPS



Generic photo used for illustration purposes only

CASE STYLE: K18

Connectors	Model
BNC	ZFDC-10-5+
SMA	ZFDC-10-5-S+
N-TYPE	ZFDC-10-5-N+
BRACKET (OPTION "B")	

+RoHS Compliant

The +Suffix identifies RoHS Compliance. See our web site for RoHS Compliance methodologies and qualifications

Outline Drawing

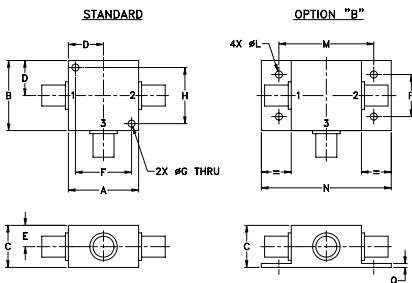

Outline Dimensions (inch/mm)

A	B	C	D	E	F	G	H
1.25	1.25	.75	.63	.38	1.00	.125	1.000
31.75	31.75	19.05	16.00	9.65	25.40	3.18	25.40

J	K	L	M	N	P	Q	wt
--	--	.125	1.688	2.18	.75	.07	grams
--	--	3.18	42.88	55.37	19.05	1.78	70.0

Directional Coupler Electrical Specifications

FREQ. RANGE (MHz)	COUPLING (dB)		MAINLINE LOSS ¹ (dB)						DIRECTIVITY (dB)						VSWR (:1)	POWER INPUT (W)	
			L		M		U		L		M		U				
			Typ.	Max.	Typ.	Max.	Typ.	Max.	Typ.	Min.	Typ.	Min.	Typ.	Min.			
1-2000	10.8±0.5	±0.5	1.2	1.9	1.2	1.8	1.8	2.5	38	25	30	18	22	18	1.3	0.5	0.5

L = low range [f_L to $10 f_L$] M = mid range [$10 f_L$ to $f_U/2$] U = upper range [$f_U/2$ to f_U]

1. Mainline loss includes theoretical power loss at coupled port.

Typical Performance Data

Frequency (MHz)	Mainline Loss (dB) In-Out	Coupling (dB) In-Cpl	Directivity (dB)	Return Loss (dB)		
				In	Out	Cpl
1.00	1.47	11.03	47.08	14.55	18.01	18.03
40.00	1.13	10.71	49.57	18.26	30.69	31.26
80.00	1.12	10.70	47.38	18.32	30.20	30.46
260.00	1.20	10.78	39.74	18.61	27.02	25.80
600.00	1.19	10.77	31.82	18.79	22.14	19.98
1050.00	1.19	10.73	26.87	18.84	19.38	15.98
1300.00	1.31	10.81	25.29	18.83	18.76	14.75
1550.00	1.34	10.96	23.98	18.70	17.75	13.90
1800.00	1.33	11.08	22.06	17.99	15.32	13.15
2000.00	1.59	11.68	19.78	16.91	12.53	12.52

ZFDC-10-5-S+ MAINLINE LOSS

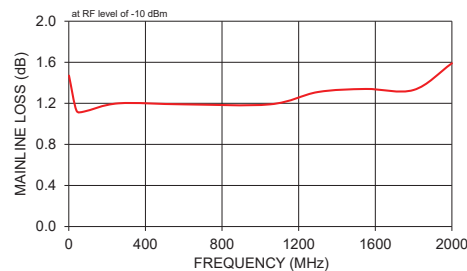

ZFDC-10-5-S+ COUPLING & DIRECTIVITY

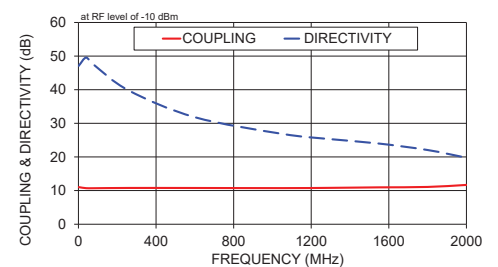

ZFDC-10-5-S+ RETURN LOSS

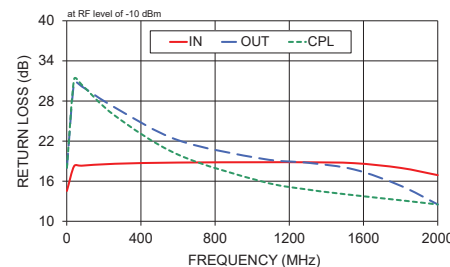

Electrical Schematic

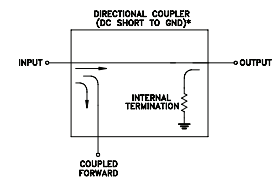

* ELECTRICAL SCHEMATIC IS FOR DIRECTIONAL COUPLER WITH INTERNAL TERMINATION THAT ROUTES DC FROM RF PORTS TO GROUND.

Notes

- Performance and quality attributes and conditions not expressly stated in this specification document are intended to be excluded and do not form a part of this specification document.
- Electrical specifications and performance data contained in this specification document are based on Mini-Circuit's applicable established test performance criteria and measurement instructions.
- The parts covered by this specification document are subject to Mini-Circuits standard limited warranty and terms and conditions (collectively, "Standard Terms"); Purchasers of this part are entitled to the rights and benefits contained therein. For a full statement of the Standard Terms and the exclusive rights and remedies thereunder, please visit Mini-Circuits' website at www.minicircuits.com/WCLStore/terms.jsp



Directional Coupler

ZFDC-10-5+

Typical Performance Data

FREQUENCY (MHz)	INSERTION LOSS (dB)	COUPLING (dB)	DIRECTIVITY (dB)	RETURN LOSS		
				IN (dB)	OUT (dB)	CPL
1.0	1.47	11.03	47.08	14.55	18.01	18.03
10.0	1.14	10.68	49.31	18.30	30.39	31.14
20.0	1.17	10.70	49.84	18.28	30.89	31.60
30.0	1.17	10.73	49.32	18.25	30.79	31.42
40.0	1.13	10.71	49.57	18.26	30.69	31.26
50.0	1.15	10.71	48.50	18.28	30.57	31.08
60.0	1.18	10.70	48.62	18.29	30.47	30.88
70.0	1.16	10.69	47.69	18.31	30.36	30.70
80.0	1.12	10.70	47.38	18.32	30.20	30.46
90.0	1.12	10.70	46.80	18.32	30.05	30.18
100.0	1.17	10.72	46.41	18.34	29.91	29.96
180.0	1.19	10.76	42.83	18.48	28.57	27.86
260.0	1.20	10.78	39.74	18.61	27.02	25.80
340.0	1.13	10.72	37.38	18.69	25.60	24.07
420.0	1.12	10.69	35.36	18.76	24.39	22.62
500.0	1.20	10.74	33.68	18.79	23.26	21.32
600.0	1.19	10.77	31.82	18.79	22.14	19.98
700.0	1.22	10.79	30.37	18.85	21.28	18.84
800.0	1.12	10.68	29.12	18.86	20.53	17.83
900.0	1.31	10.78	28.14	18.80	19.91	16.97
1000.0	1.21	10.78	27.20	18.73	19.46	16.28
1050.0	1.19	10.73	26.87	18.84	19.38	15.98
1100.0	1.23	10.75	26.49	18.75	19.19	15.71
1150.0	1.32	10.85	26.16	18.77	19.05	15.41
1200.0	1.16	10.73	25.82	18.83	19.01	15.22
1250.0	1.22	10.77	25.57	18.73	18.79	14.97
1300.0	1.31	10.81	25.29	18.83	18.76	14.75
1350.0	1.20	10.77	25.02	18.79	18.60	14.60
1400.0	1.26	10.84	24.74	18.75	18.42	14.36
1450.0	1.31	10.87	24.49	18.82	18.30	14.24
1500.0	1.25	10.83	24.28	18.67	17.96	14.06
1550.0	1.34	10.96	23.98	18.70	17.75	13.90
1600.0	1.37	10.99	23.68	18.62	17.35	13.79
1650.0	1.28	10.89	23.33	18.43	16.91	13.58
1700.0	1.35	11.03	22.97	18.42	16.49	13.48
1750.0	1.44	11.13	22.57	18.14	15.85	13.31
1800.0	1.33	11.08	22.06	17.99	15.32	13.15
1850.0	1.51	11.30	21.59	17.81	14.65	13.04
1900.0	1.52	11.31	21.06	17.45	13.96	12.83
1950.0	1.41	11.40	20.38	17.28	13.30	12.70
2000.0	1.59	11.68	19.78	16.91	12.53	12.52

REV. X1
ZFDC-10-5+
060718
Page 1 of 1



IF/RF MICROWAVE COMPONENTS • ISO 9001 ISO 14001 AS 9100 CERTIFIED • RoHS compliant
P.O. Box 350166, Brooklyn, New York 11235-0003 (718) 934-4500 Fax (718) 332-4661



The Design Engineers Search Engine finds the model you need, Instantly • For detailed performance specs & shopping online see



Directional Coupler

ZFDC-10-5+

Typical Performance Curves

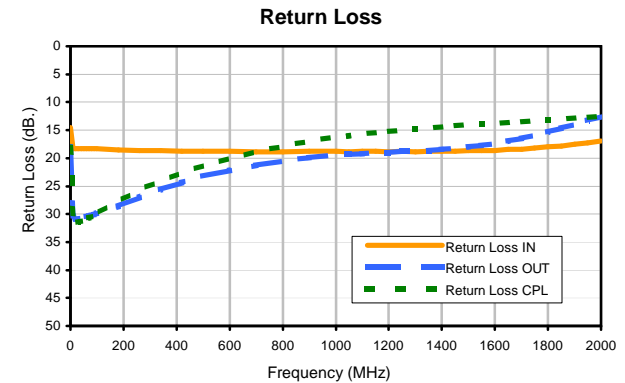
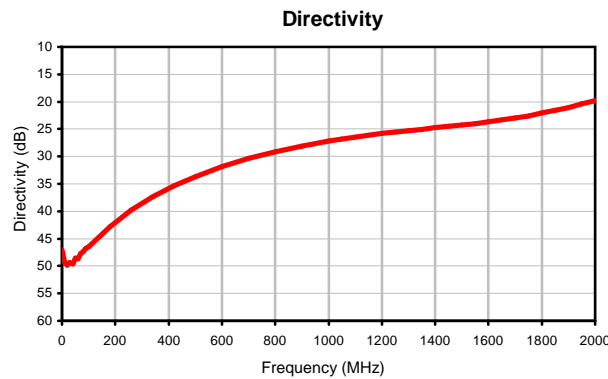
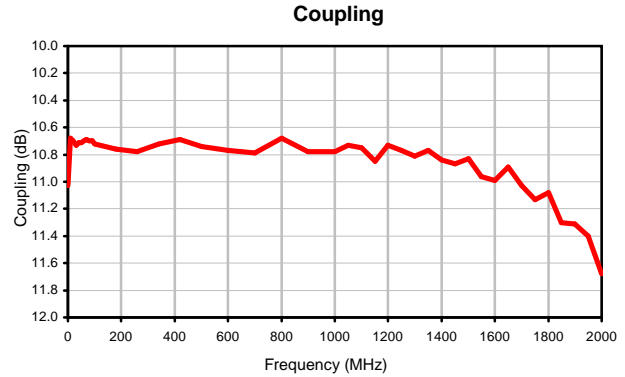
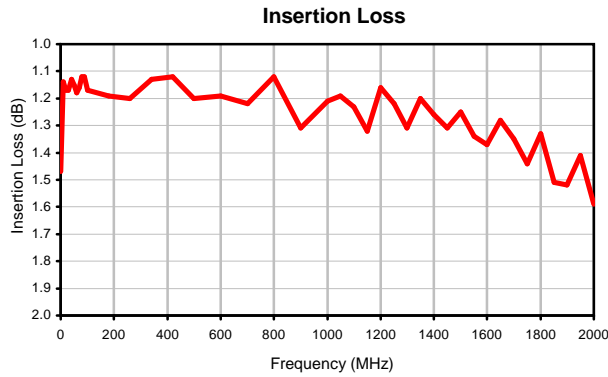

REV. X1
ZFDC-10-5+
060718
Page 1 of 1



IF/RF MICROWAVE COMPONENTS • ISO 9001 ISO 14001 AS 9100 CERTIFIED • RoHS compliant
P.O. Box 350166, Brooklyn, New York 11235-0003 (718) 934-4500 Fax (718) 332-4661



The Design Engineers Search Engine finds the model you need, Instantly • For detailed performance specs & shopping online see



Case Style

K

K18

Outline Dimensions

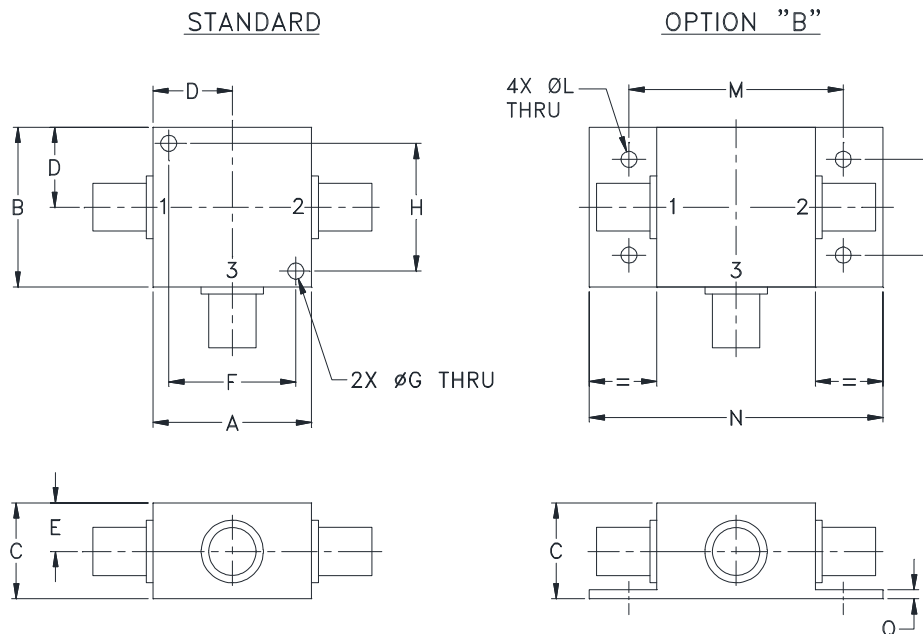

CASE#	A	B	C	D	E	F	G	H	J	K	L	M	N
K18	1.25 (31.75)	1.25 (31.75)	.75 (19.05)	.63 (16.00)	.38 (9.65)	1.000 (25.40)	.125 (3.18)	1.000 (25.40)	--	--	.125 (3.18)	1.688 (42.88)	2.18 (55.37)

CASE#	P	Q	WT. GRAMS
K18	.75 (19.05)	.07 (1.78)	70.0

Dimensions are in inches (mm). Tolerances: 2 Pl. \pm .03; 3 Pl. \pm .015

Notes:

- Case material: Aluminum alloy.
- Case finish:
For RoHS Case Styles: Clear chemical conversion coating, non-chrome or trivalent chrome based.
- Mounting bracket available on request. Add suffix B to part number.
- For port marking 1, 2, and 3 see specifications data sheet.
- For bracket version, option B, dimension "C" changes from .75 to .94 inches when connectors are type N.
- Refer to the individual model data sheet for the type of connectors available.



INTERNET <http://www.minicircuits.com>

P.O. Box 350166, Brooklyn, New York 11235-0003 (718) 934-4500 Fax (718) 332-4661

Distribution Centers NORTH AMERICA 800-654-7949 • 417-335-5935 • Fax 417-335-5945 • EUROPE 44-1252-832600 • Fax 44-1252-837010

Mini-Circuits ISO 9001 & ISO 14001 Certified

All Mini-Circuits products are manufactured under exacting quality assurance and control standards, and are capable of meeting published specifications after being subjected to any or all of the following physical and environmental test.

Specification	Test/Inspection Condition	Reference/Spec
Operating Temperature	-55° to 100°C Ambient Environment	Individual Model Data Sheet
Storage Temperature	-55° to 100° C Ambient Environment	Individual Model Data Sheet
Barometric Pressure	100,000 Feet	MIL-STD-202, Method 105, Condition D
Humidity	90% RH, 65°C Units may require bake-out after humidity to restore full performance.	MIL-STD-202, Method 103
Thermal Shock	-65° to 125°C, 5 cycles	MIL-STD-202, Method 107, Condition B
Vibration (High Frequency)	20g peak, 10-2000 Hz, 12 times in each of three perpendicular directions (total 36)	MIL-STD-202, Method 204, Condition D
Mechanical Shock	100g, 6ms sawtooth, 3 shocks each direction 3 axes (total 18)	MIL-STD-202, Method 213, Condition I