

# Coaxial Diplexer

## ZDPL-6588-75-F+

75Ω 5 to 1700 MHz  
(5 - 65, 88-1700 MHz)

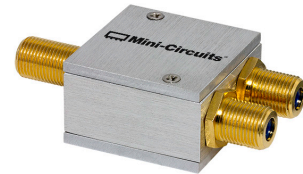

Generic photo used for illustration purposes only  
CASE STYLE: F2239

### The Big Deal

- Low insertion loss, 1.2 dB typical
- High rejection
- High crossover isolation
- Excellent return loss
- 75Ω Impedance
- Used in DOCSIS 3.1 standard test systems with extended range

### Product Overview

ZDPL-6588-75-F+ is a high performance diplexer with the lowpass port at 5-65 MHz and highpass port at 88-1700 MHz. Excellent return loss over extended frequency combined with high out of channel rejection makes it a ideal component in DOCSIS 3.1 test equipments, cable TV and multiband radio systems.

### Key Features

Feature	Advantages
Low passband insertion loss	Passband insertion loss 1.2 dB typical ensures low signal loss through the both channels.
Excellent stopband rejection	Co-channel rejection of 50 dB typical ensures unwanted spurious are eliminated
Excellent return loss at 5-65 and 88-1700 MHz	This makes signal transmission with less reflections and well- matched with the adjacent component used in the system.

#### Notes

- A. Performance and quality attributes and conditions not expressly stated in this specification document are intended to be excluded and do not form a part of this specification document.  
B. Electrical specifications and performance data contained in this specification document are based on Mini-Circuit's applicable established test performance criteria and measurement instructions.  
C. The parts covered by this specification document are subject to Mini-Circuits standard limited warranty and terms and conditions (collectively, "Standard Terms"); Purchasers of this part are entitled to the rights and benefits contained therein. For a full statement of the Standard Terms and the exclusive rights and remedies thereunder, please visit Mini-Circuits' website at [www.minicircuits.com/MCLStore/terms.jsp](http://www.minicircuits.com/MCLStore/terms.jsp)



# Coaxial Diplexer

75Ω 5 to 1700 MHz (5-65, 88-1700 MHz)

## ZDPL-6588-75-F+



Generic photo used for illustration purposes only

CASE STYLE: F2239

Connectors Model  
F-Female ZDPL-6588-75-F+  
BRACKET (OPTION "B")

### Maximum Ratings

Operating Temperature	-40°C to 85°C
Storage Temperature	-55°C to 100°C
RF Power Input	30 dBm Max.

Permanent damage may occur if any of these limits are exceeded.

### Coaxial Connections

HIGH PASS PORT	3
LOW PASS PORT	2
COMMON PORT	1

### Features

- Low insertion loss
- Excellent return loss
- High rejection
- High cross over isolation
- 75Ω impedance

### Applications

- Cable TV and Multiband radio systems
- DOCSIS 3.1 test system with extended range

### +RoHS Compliant

The +Suffix identifies RoHS Compliance. See our web site for RoHS Compliance methodologies and qualifications

### Outline Drawing

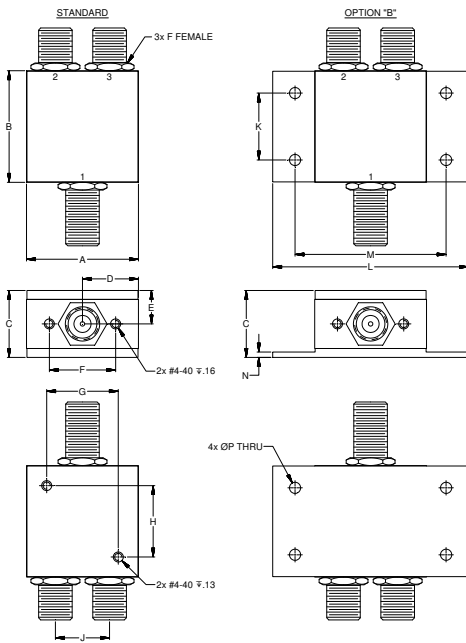

### Outline Dimensions (inch/mm)

A	B	C	D	E	F	G	H
1.25	1.25	.75	.63	.38	.74	.80	.80
31.75	31.75	19.05	15.88	9.53	18.80	20.32	20.32
J	K	L	M	N	P	Wt.	
.61	.75	2.19	1.69	.06	.125	grams	
15.37	19.05	55.58	42.88	1.52	3.18	85	

Note: Please refer to case style drawing for details

### Electrical Specifications at 25°C

Parameter	Port	Frequency (MHz)	Min.	Typ.	Max.	Unit	
Pass Band	Insertion Loss	Low Pass	5-65	-	1.0	1.5	dB
		High Pass	88-1220	-	1.2	1.5	
			1220-1400	-	1.0	1.5	
	Return Loss	Low Pass	5-65	20	24	-	dB
		High Pass	88-1220	17	20	-	
			1220-1400	17	20	-	
Common		5-65	20	24	-		
Stop Band	Isolation	Low Pass	88-1220	45	50	-	dB
		High Pass	1220-1700	50	60	-	
		Common	5-65	45	50	-	
Cross Over Isolation	LP-HP	65-88	32	35	-	dB	

### Typical Performance Data at 25°C

FREQUENCY (MHz)	INSERTION LOSS (dB)		ISOLATION (dB)		RETURN LOSS (dB)	
	Low Pass Port	High Pass Port	LP-HP Port	Common Port	Low Pass Port	High Pass Port
1	0.01	83.62	94.01	49.09	48.16	0.01
5	0.05	82.40	79.67	44.23	41.53	0.02
50	0.34	52.96	52.60	30.83	29.57	0.16
65	0.99	52.36	54.43	33.88	32.31	0.47
70	3.48	38.25	42.75	8.09	8.10	0.73
71	5.73	32.62	40.99	5.00	4.76	0.82
73	13.08	23.11	40.56	2.47	1.89	1.08
74	17.59	19.12	41.28	2.18	1.39	1.29
75	22.46	15.43	42.33	2.22	1.13	1.62
76	27.79	11.99	43.75	2.58	0.97	2.16
77	33.82	8.91	45.97	3.35	0.86	3.06
78	40.84	6.35	49.10	4.75	0.79	4.55
79	48.60	4.45	53.82	6.95	0.74	6.80
80	53.28	3.20	59.99	10.01	0.69	9.87
85	55.63	1.44	54.49	39.65	0.57	31.50
88	54.94	1.19	54.00	36.40	0.53	33.70
250	66.12	0.41	65.65	26.75	0.32	35.19
500	68.32	0.46	67.78	28.01	0.27	26.26
1000	69.92	0.64	66.14	25.30	0.42	21.19
1220	68.18	0.74	65.69	26.36	0.55	22.53
1400	68.20	0.83	63.34	25.14	0.69	25.74
1700	58.58	1.11	57.80	21.79	1.10	35.11

### Functional Schematic

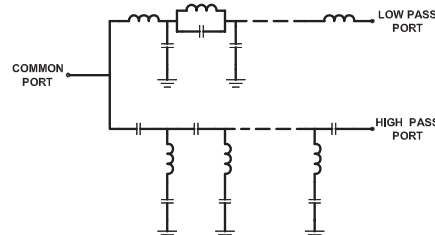

### Notes

- Performance and quality attributes and conditions not expressly stated in this specification document are intended to be excluded and do not form a part of this specification document.
- Electrical specifications and performance data contained in this specification document are based on Mini-Circuit's applicable established test performance criteria and measurement instructions.
- The parts covered by this specification document are subject to Mini-Circuits standard limited warranty and terms and conditions (collectively, "Standard Terms"); Purchasers of this part are entitled to the rights and benefits contained therein. For a full statement of the Standard Terms and the exclusive rights and remedies thereunder, please visit Mini-Circuits' website at [www.minicircuits.com/VOLStore/terms.jsp](http://www.minicircuits.com/VOLStore/terms.jsp)



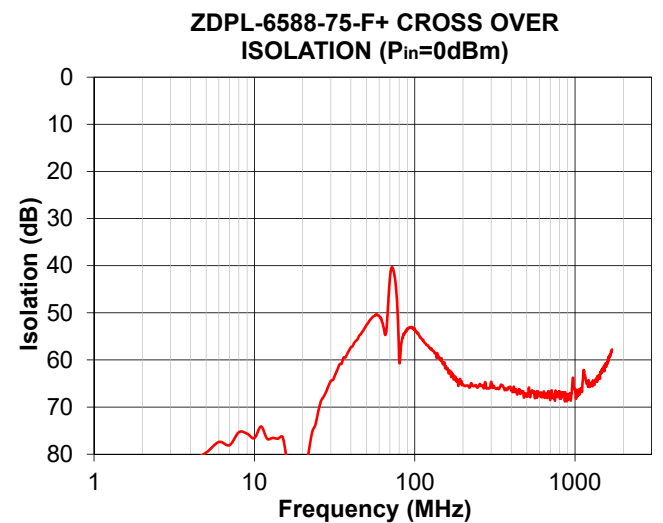
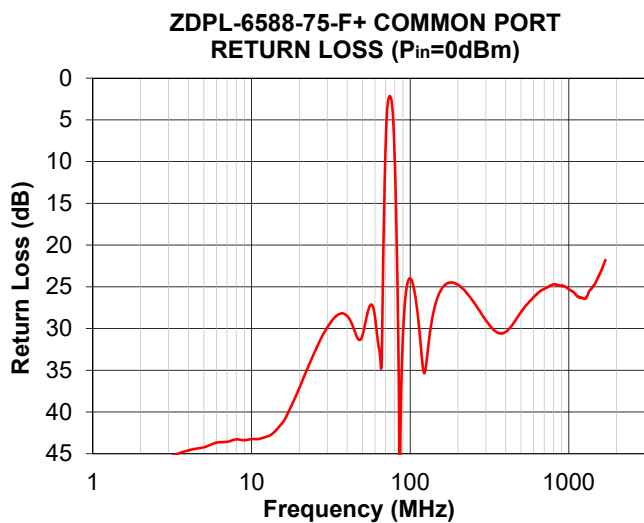
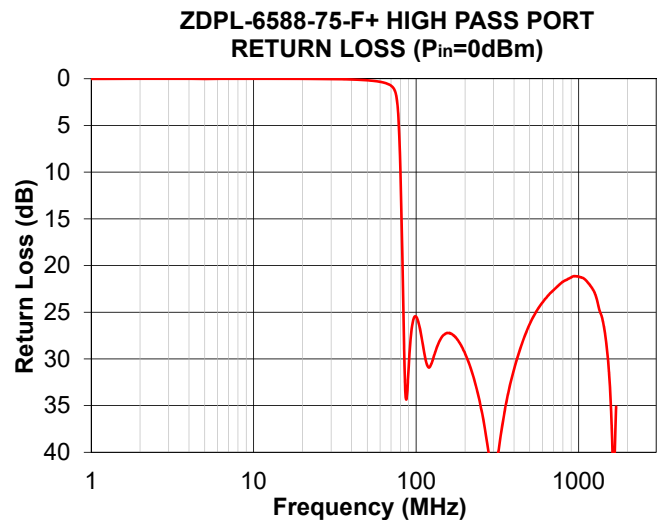
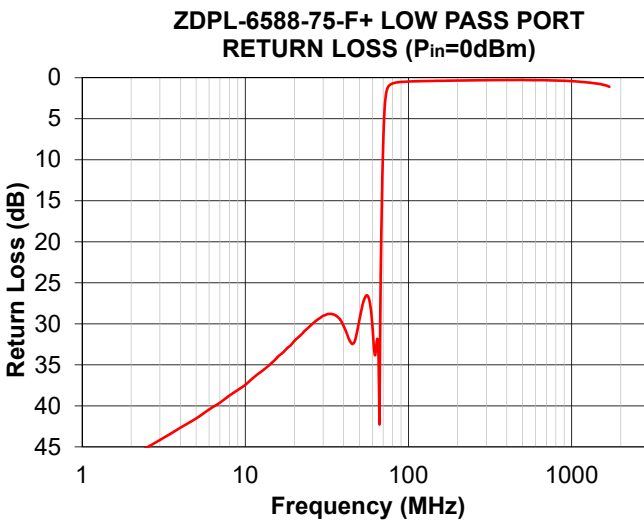
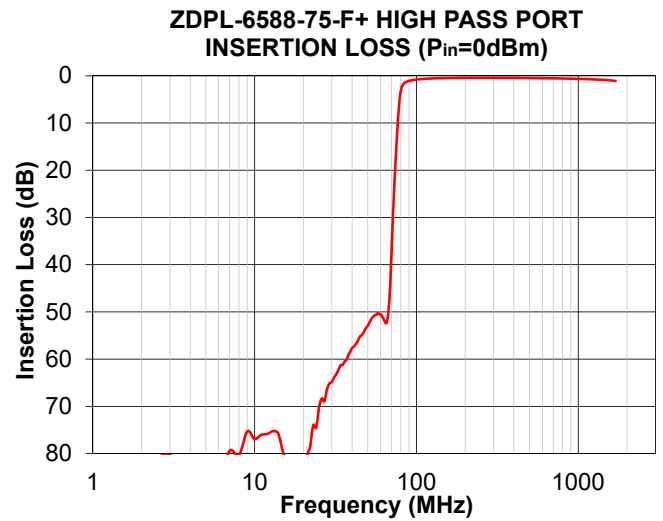
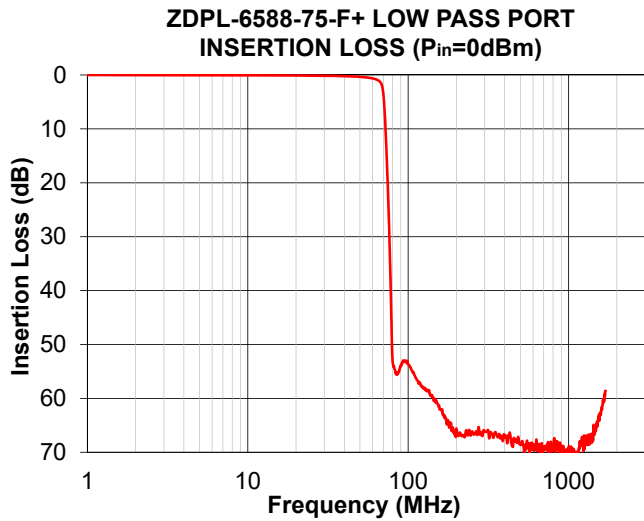

Notes

- A. Performance and quality attributes and conditions not expressly stated in this specification document are intended to be excluded and do not form a part of this specification document.
- B. Electrical specifications and performance data contained in this specification document are based on Mini-Circuit's applicable established test performance criteria and measurement instructions.
- C. The parts covered by this specification document are subject to Mini-Circuits standard limited warranty and terms and conditions (collectively, "Standard Terms"); Purchasers of this part are entitled to the rights and benefits contained therein. For a full statement of the Standard Terms and the exclusive rights and remedies thereunder, please visit Mini-Circuits' website at [www.minicircuits.com/MCLStore/terms.jsp](http://www.minicircuits.com/MCLStore/terms.jsp)



## Typical Performance Data

FREQUENCY (MHz)	INSERTION LOSS (dB)		Cross over isolation (dB) (between LPF and HPF)	RETURN LOSS (dB)		
	Lowpass port	Highpass port		Common port	Lowpass port	Highpass port
1	0.01	83.62	94.01	49.09	48.16	0.01
5	0.05	82.40	79.67	44.23	41.53	0.02
10	0.07	76.91	76.60	43.25	37.45	0.00
30	0.15	64.86	64.44	29.87	29.02	0.03
40	0.21	57.66	57.32	28.50	30.25	0.08
50	0.34	52.96	52.60	30.83	29.57	0.16
60	0.63	50.65	50.68	28.62	30.02	0.33
61	0.68	50.72	51.11	29.72	32.05	0.35
62	0.74	51.17	51.40	30.97	33.68	0.38
63	0.81	51.67	52.13	31.98	33.37	0.40
64	0.89	52.11	53.10	32.68	32.08	0.44
65	0.99	52.36	54.43	33.88	32.31	0.47
66	1.12	51.78	54.50	34.46	37.75	0.51
67	1.31	50.11	52.61	26.75	31.93	0.55
68	1.62	47.45	49.26	18.84	20.32	0.61
69	2.23	43.54	45.57	12.71	13.16	0.66
70	3.48	38.25	42.75	8.09	8.10	0.73
71	5.73	32.62	40.99	5.00	4.76	0.82
72	9.04	27.53	40.36	3.27	2.86	0.93
73	13.08	23.11	40.56	2.47	1.89	1.08
74	17.59	19.12	41.28	2.18	1.39	1.29
75	22.46	15.43	42.33	2.22	1.13	1.62
76	27.79	11.99	43.75	2.58	0.97	2.16
77	33.82	8.91	45.97	3.35	0.86	3.06
78	40.84	6.35	49.10	4.75	0.79	4.55
79	48.60	4.45	53.82	6.95	0.74	6.80
80	53.28	3.20	59.99	10.01	0.69	9.87
81	54.15	2.45	59.85	13.87	0.66	13.64
82	54.40	2.01	57.42	18.46	0.63	17.98
83	54.86	1.74	56.02	23.84	0.61	22.70
84	55.25	1.56	55.16	30.41	0.59	27.49
85	55.63	1.44	54.49	39.65	0.57	31.50
86	55.43	1.34	54.54	55.82	0.56	33.86
87	55.02	1.26	54.27	41.21	0.54	34.35
88	54.94	1.19	54.00	36.40	0.53	33.70
89	54.32	1.13	53.83	33.20	0.52	32.29
90	53.99	1.08	53.57	30.85	0.51	30.81
91	53.53	1.04	53.31	29.05	0.51	29.44
95	53.04	0.91	53.05	25.07	0.48	26.21
100	53.65	0.80	53.44	23.99	0.46	25.48
110	55.76	0.66	55.46	27.36	0.43	28.49
150	60.46	0.48	60.84	26.09	0.38	27.36
200	65.61	0.42	65.25	24.77	0.35	29.43
250	66.12	0.41	65.65	26.75	0.32	35.19
500	68.32	0.46	67.78	28.01	0.27	26.26
750	71.44	0.55	68.60	24.93	0.33	22.14
1000	69.92	0.64	66.14	25.30	0.42	21.19
1100	70.02	0.69	66.40	25.89	0.48	21.52
1220	68.18	0.74	65.69	26.36	0.55	22.53
1300	68.27	0.79	64.76	26.20	0.61	23.76
1350	66.86	0.82	64.00	25.48	0.65	24.91
1400	68.20	0.83	63.34	25.14	0.69	25.74
1450	66.03	0.86	62.68	24.75	0.74	27.17
1500	64.43	0.89	61.83	24.21	0.78	29.28
1550	63.87	0.93	60.78	23.66	0.84	32.37
1600	62.07	0.99	60.17	23.11	0.91	37.68
1650	60.38	1.04	58.87	22.45	0.99	42.63
1670	59.80	1.07	58.63	22.17	1.04	39.74
1680	59.16	1.08	58.08	22.06	1.06	38.00
1700	58.58	1.11	57.80	21.79	1.10	35.11

# Coaxial Diplexer

# ZDPL-6588-75-F+

## Typical Performance Curves

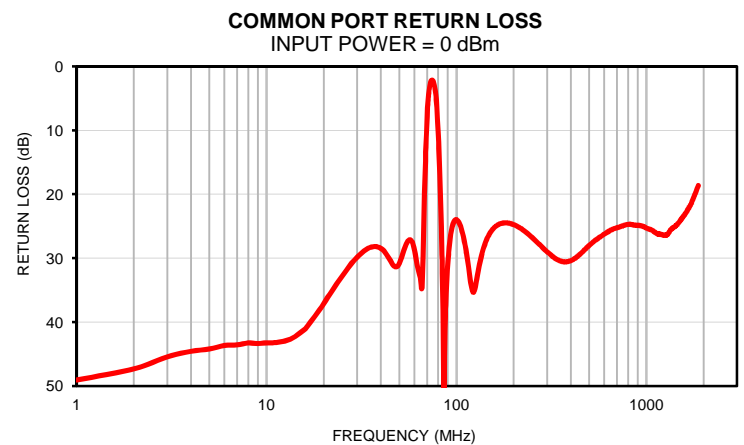
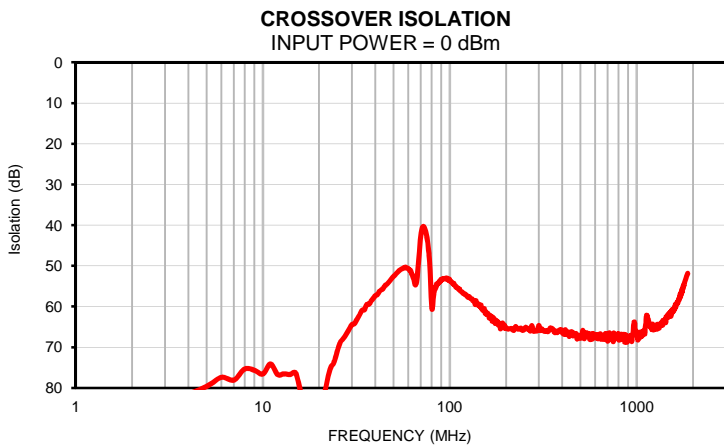
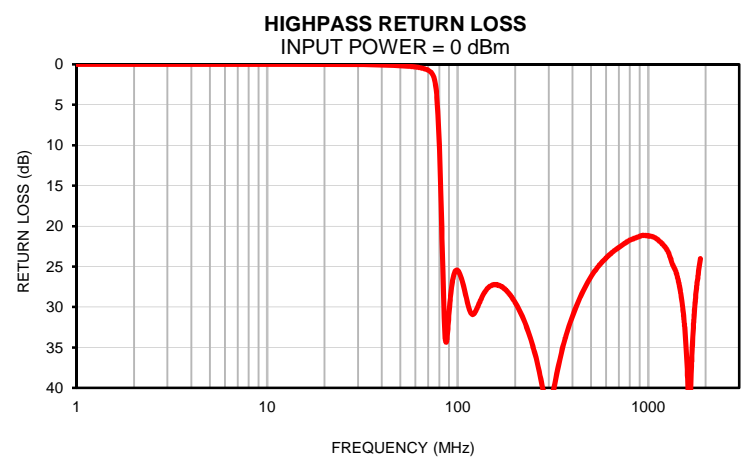
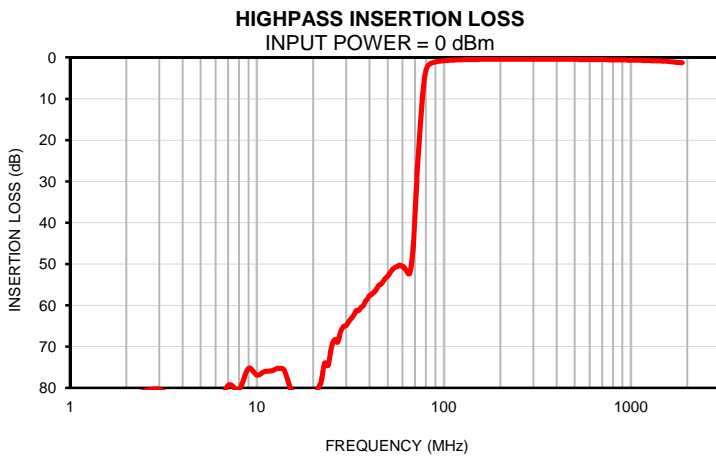
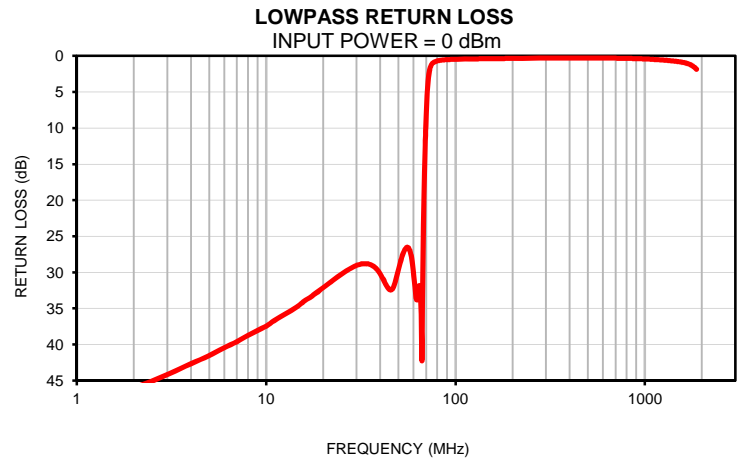
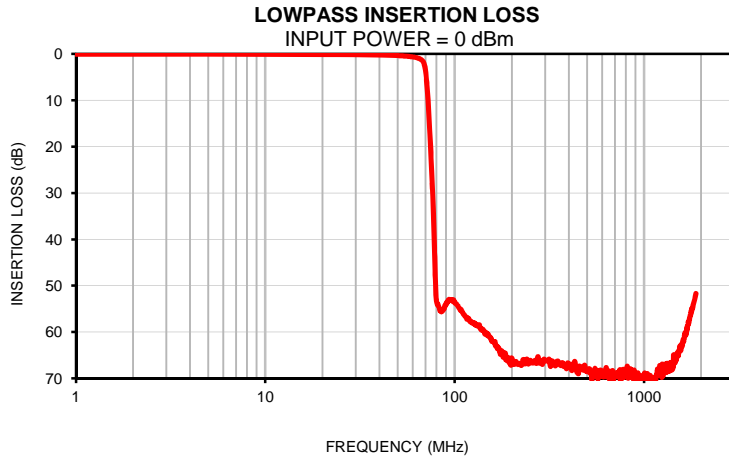

### Outline Dimensions

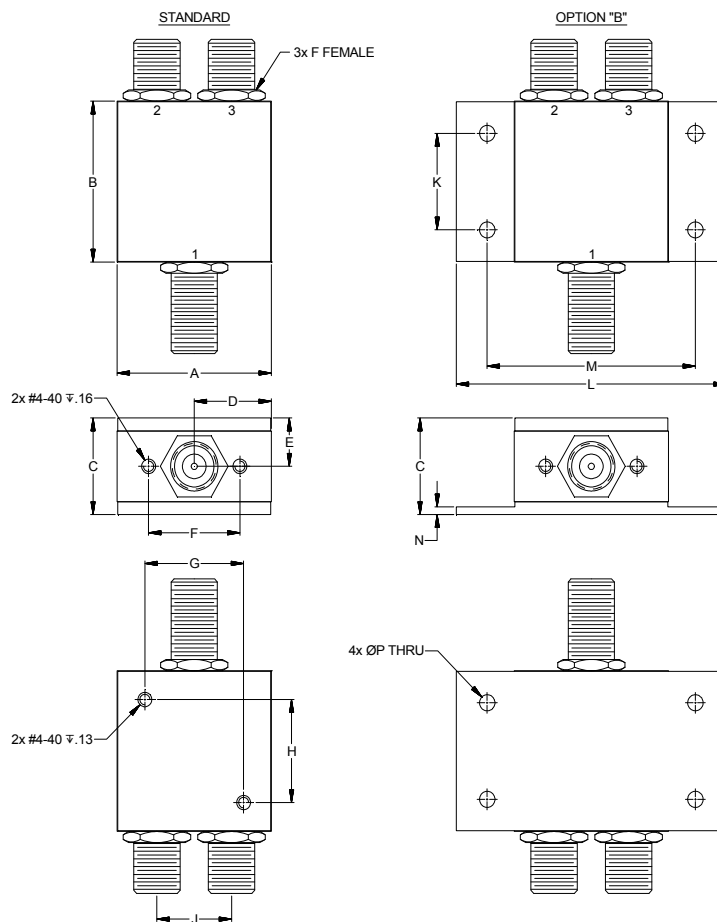

CASE#	A	B	C	D	E	F	G	H	J
F2239	1.25 (31.75)	1.25 (31.75)	.75 (19.05)	.63 (15.88)	.38 (9.53)	.74 (18.80)	.80 (20.32)	.80 (20.32)	.61 (15.37)

CASE#	K	L	M	N	P	WT.GRAMS
F2239	.75 (19.05)	2.19 (55.58)	1.69 (42.88)	.06 (1.52)	.125 (3.18)	85

Dimensions are in inches (mm). Tolerances: 2Pl. ± .03; 3Pl. ± .015

#### Notes:

- Case material: Aluminum alloy.
- Case finish:
  - For RoHS Case Styles: Clear chemical conversion coating, non-chrome or trivalent chrome based.
- Mounting bracket available on request: Add suffix B to part number.
- For Bracket version, option "B" dimension "C" changes from .76 to 1.00 inches when connectors type change.
- Refer to the individual model sheet for the type of connectors available.



INTERNET <http://www.minicircuits.com>

P.O. Box 350166, Brooklyn, New York 11235-0003 (718) 934-4500 Fax (718) 332-4661

Distribution Centers NORTH AMERICA 800-654-7949 • 417-335-5935 • Fax 417-335-5945 • EUROPE 44-1252-832600 • Fax 44-1252-837010

Mini-Circuits ISO 9001 & ISO 14001 Certified

All Mini-Circuits products are manufactured under exacting quality assurance and control standards, and are capable of meeting published specifications after being subjected to any or all of the following physical and environmental test.

Specification	Test/Inspection Condition	Reference/Spec
Operating Temperature	-55° to 100°C Ambient Environment	Individual Model Data Sheet
Storage Temperature	-55° to 100° C Ambient Environment	Individual Model Data Sheet
Humidity	90 to 95% RH, 40°C, 96 hours; Units may require bake-out after humidity to restore full performance.	MIL-STD-202, Method 103, Condition B
Thermal Shock	-55° to 100°C, 100 cycles	MIL-STD-202, Method 107, Condition A-3, except +100°C
Vibration (High Frequency)	20g peak, 10-2000 Hz, 12 times in each of three perpendicular directions (total 36)	MIL-STD-202, Method 204, Condition D
Mechanical Shock	50g, 11ms half-sine, 3 shocks each direction 3 axes (total 18)	MIL-STD-202, Method 213, Condition A