

# Wideband, DC Pass Directional Coupler

## ZCDC13-E1653+

50Ω 13dB Up to 11W 1 to 65 GHz

### The Big Deal

- Ultra Wideband, 1 to 65 GHz
- Excellent Coupling Flatness, ±0.9 dB typ.
- Power Handling up to 11W



CASE STYLE: HT2679

### Product Overview

The Mini-Circuits ZCDC13-E1653+ ultra wideband directional coupler offers exceptional performance operating over 1 to 65 GHz. This coupler has excellent coupling flatness, good directivity, and power handling. It is ideal for lab testing applications as well as for power monitoring over wide bands, among other applications.

### Key Features

Feature	Advantages
Ultra-wide bandwidth	With an ultra-wide bandwidth spanning 1 to 65 GHz, ZCDC13-E1653+ coupler is ideal for most lab testing applications, avoiding the need to switch components for different frequency bands.
Excellent Directivity • 17 dB typ. up to 65 GHz	High directivity allows sampling of input powers with minimal detrimental effects due to output mismatches.
Excellent coupling flatness, ±0.9 dB typ	Excellent coupling flatness over the entire frequency range minimizes the need for compensation circuits in most cases.
Excellent Return Loss (In & Out) • 16 dB typ. up to 65 GHz	Good return loss over 1 to 65 GHz minimizes undesired reflections and resulting amplitude ripple.

#### Notes

- A. Performance and quality attributes and conditions not expressly stated in this specification document are intended to be excluded and do not form a part of this specification document.  
B. Electrical specifications and performance data contained in this specification document are based on Mini-Circuit's applicable established test performance criteria and measurement instructions.  
C. The parts covered by this specification document are subject to Mini-Circuits standard limited warranty and terms and conditions (collectively, "Standard Terms"); Purchasers of this part are entitled to the rights and benefits contained therein. For a full statement of the Standard Terms and the exclusive rights and remedies thereunder, please visit Mini-Circuits' website at [www.minicircuits.com/MCLStore/terms.jsp](http://www.minicircuits.com/MCLStore/terms.jsp)



# Wideband, DC Pass Directional Coupler

## ZCDC13-E1653+

50Ω 13dB Up to 11W 1 to 65 GHz



Generic photo used for illustration purposes only

CASE STYLE: HT2679

Connectors Model  
1.85mm Female ZCDC13-E1653+

+RoHS Compliant

The +Suffix identifies RoHS Compliance. See our web site for RoHS Compliance methodologies and qualifications

### Maximum Ratings

Operating Temperature	-55°C to 100°C
Storage Temperature	-55°C to 100°C
Supplied Termination*	1 W
DC Current	0.46A

Permanent damage may occur if any of these limits are exceeded  
\* up to 25°C, derates linearly to 325mW at 100°C.

### Coaxial Connections

INPUT	IN
OUTPUT	OUT
COUPLED	CPL
TERMINATION (50Ω) INCLUDED	—

### Outline Drawing

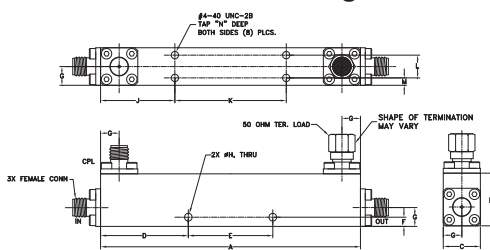

### Outline Dimensions (inch/mm)

A	B	C	D	E	F	G	
3.50	0.70	0.50	1.181	1.138	0.122	0.25	
88.90	17.78	12.70	30.00	28.91	3.10	6.35	
H	J	K	L	M	N	wt	
0.102	1.00	1.50	0.303	0.098	0.2	grams	
2.59	25.40	38.10	7.70	2.5	5.08	80	

### Electrical Schematic

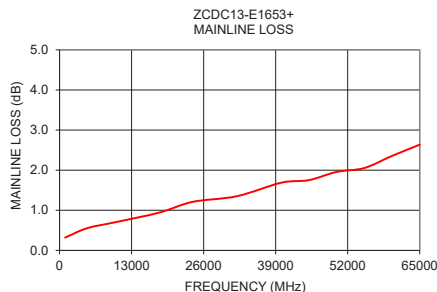
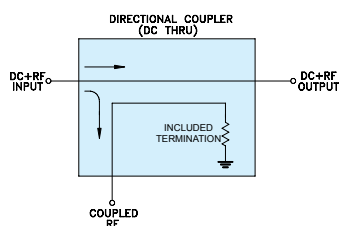

### Features

- Ultra wide frequency range, 1 to 65 GHz
- Good coupling flatness, ±0.9 dB typ.
- Good directivity, 17 dB typ. up to 65 GHz
- Excellent return loss, 16 dB typ. up to 50 GHz
- DC current pass through input to output

### Applications

- 5G
- Mobile
- Fixed satellite
- Lab use

### Electrical Specifications at 25°C

Parameter	Frequency (GHz)	Min.	Typ.	Max.	Units
Operating Frequency		1		65	GHz
Nominal Coupling	1 - 65	-	13±2.5	-	dB
Coupling Flatness	1 - 65	-	±0.9	±1.5	dB
Mainline Loss <sup>1</sup>	1 - 18	-	0.7	1.8	dB
	18 - 40	-	1.3	2.7	
	40 - 50	-	1.8	3.0	
	50 - 65	-	2.3	3.5	
Directivity	1 - 18	14	29	-	dB
	18 - 40	10	22	-	
	40 - 50	8	21	-	
	50 - 65	7	19	-	
Return Loss (In & Out)	1 - 18	12.7	32	-	dB
	18 - 40	11.7	26	-	
	40 - 50	10.8	24	-	
	50 - 65	10.1	23	-	
Return Loss (Coupling)	1 - 18	12.7	29	-	dB
	18 - 40	11.7	23	-	
	40 - 50	10.8	22	-	
	50 - 65	10.1	21	-	
Input Power <sup>2</sup>	1 - 65	-	-	11	W

1. Mainline loss includes coupling loss  
2. up to 25°C, derates linearly to 4W at 100°C.

### Typical Performance Data

Frequency (MHz)	Mainline Loss <sup>1</sup> (dB) In-Out	Coupling (dB) In-Cpl	Directivity (dB)	Return Loss (dB)		
				In	Out	Cpl
1000	0.32	14.39	29.14	29.80	35.84	26.03
5000	0.55	14.12	33.76	24.98	25.84	33.96
10000	0.70	14.28	32.39	30.62	31.88	28.91
18000	0.94	14.51	20.08	43.26	35.20	20.61
24000	1.21	14.57	21.26	17.03	17.55	17.34
32000	1.35	14.33	19.89	43.36	34.68	28.99
40000	1.69	14.17	19.05	16.49	16.74	18.24
50000	1.96	14.39	19.24	17.00	17.55	31.08
60000	2.36	13.66	17.95	21.32	22.44	19.39
65000	2.64	13.00	16.96	16.82	19.74	17.16

1. Mainline loss includes coupling loss

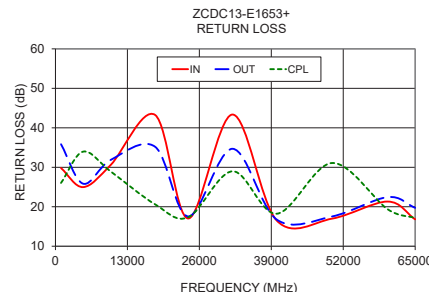
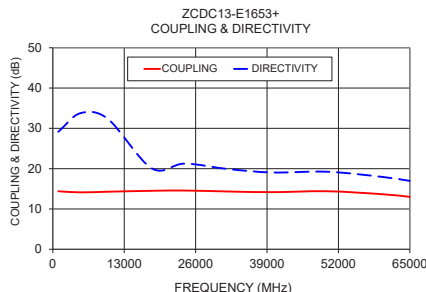

### Notes

- Performance and quality attributes and conditions not expressly stated in this specification document are intended to be excluded and do not form a part of this specification document.
- Electrical specifications and performance data contained in this specification document are based on Mini-Circuit's applicable established test performance criteria and measurement instructions.
- The parts covered by this specification document are subject to Mini-Circuits standard limited warranty and terms and conditions (collectively, "Standard Terms"); Purchasers of this part are entitled to the rights and benefits contained therein. For a full statement of the Standard Terms and the exclusive rights and remedies thereunder, please visit Mini-Circuits' website at [www.minicircuits.com/WCLStore/terms.jsp](http://www.minicircuits.com/WCLStore/terms.jsp)



[www.minicircuits.com](http://www.minicircuits.com) P.O. Box 350166, Brooklyn, NY 11235-0003 (718) 934-4500 sales@minicircuits.com

REV. OR  
ECO-002260  
ZCDC13-E1653+  
WP/CP/AM  
200324  
Page 2 of 2

# Directional Coupler

# ZCDC13-E1653+

## Typical Performance Data

FREQ. (MHz)	INSERTION LOSS <sup>(1)</sup> (dB)	COUPLING (dB)	DIRECTIVITY (dB)	RETURN LOSS (dB)		
				IN	OUT	CPL
1000	0.32	14.39	29.14	29.80	35.84	26.03
2000	0.38	14.54	34.84	30.30	29.54	26.55
3000	0.44	14.52	32.25	30.18	28.76	44.42
4000	0.50	14.26	36.61	26.09	26.45	30.88
5000	0.55	14.12	33.76	24.98	25.84	33.96
6000	0.59	14.18	29.95	25.79	26.14	30.95
7000	0.61	14.25	30.33	30.24	32.47	36.10
8000	0.65	13.90	23.44	40.70	51.34	33.64
9000	0.68	13.92	23.72	35.85	39.80	31.25
10000	0.70	14.28	32.39	30.62	31.88	28.91
11000	0.73	14.26	26.20	31.41	31.23	30.50
12000	0.77	14.05	21.90	35.72	36.84	38.26
14000	0.83	14.37	29.88	27.09	28.57	29.12
16000	0.91	14.23	45.03	23.91	23.57	32.72
18000	0.94	14.51	20.08	43.26	35.20	20.61
20000	1.00	14.31	24.69	32.02	34.51	17.67
22000	1.09	14.44	16.20	22.56	22.92	18.39
24000	1.21	14.57	21.26	17.03	17.55	17.34
26000	1.22	14.37	24.35	20.04	20.03	20.18
28000	1.21	14.69	27.73	35.45	33.36	21.51
30000	1.27	14.37	28.41	34.46	39.17	21.68
32000	1.35	14.33	19.89	43.36	34.68	28.99
34000	1.44	14.34	25.58	26.79	29.27	30.23
36000	1.49	14.50	20.79	32.67	37.91	31.90
38000	1.61	14.42	27.03	17.31	17.97	18.00
40000	1.69	14.17	19.05	16.49	16.74	18.24
42000	1.68	14.38	17.59	18.64	19.38	29.09
44000	1.75	14.03	21.75	20.68	21.50	25.21
46000	1.73	14.10	20.30	25.71	34.31	27.87
48000	1.82	14.29	21.15	19.49	21.31	28.83
50000	1.96	14.39	19.24	17.00	17.55	31.08
52000	1.98	14.49	17.78	18.94	20.11	31.76
54000	2.03	14.10	19.14	20.35	21.61	19.72
56000	2.06	14.69	16.28	29.68	35.14	16.32
58000	2.18	14.10	24.43	24.76	26.91	17.03
60000	2.36	13.66	17.95	21.32	22.44	19.39
62000	2.45	13.55	21.04	17.80	20.49	21.10
63000	2.57	13.70	17.89	15.31	18.54	17.69
64000	2.57	13.66	17.64	16.53	19.28	16.46
65000	2.64	13.00	16.96	16.82	19.74	17.16

<sup>(1)</sup> Mainline loss includes coupling loss

# Directional Coupler

## Typical Performance Curves

# ZCDC13-E1653+

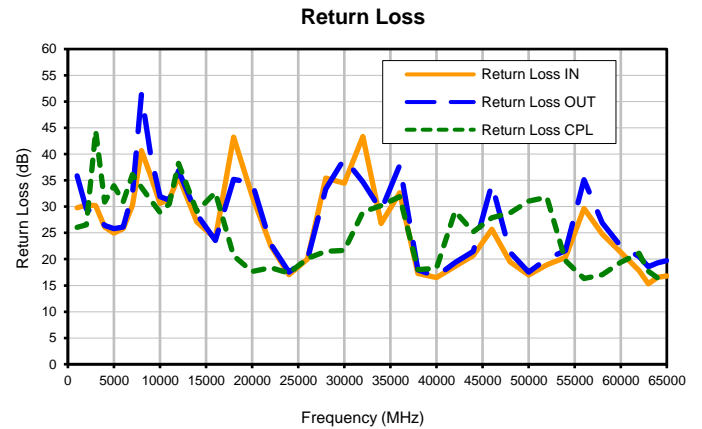
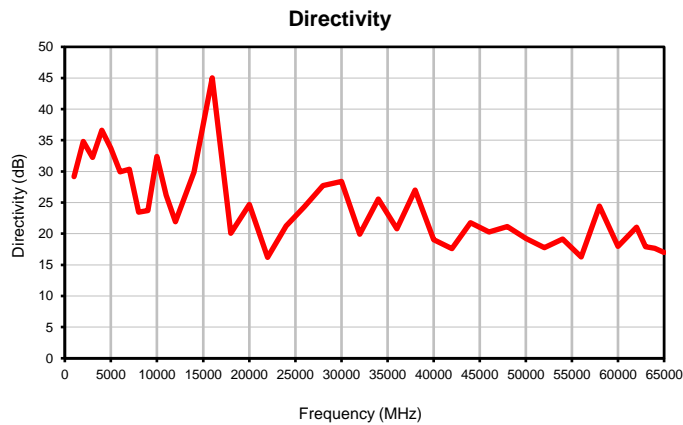
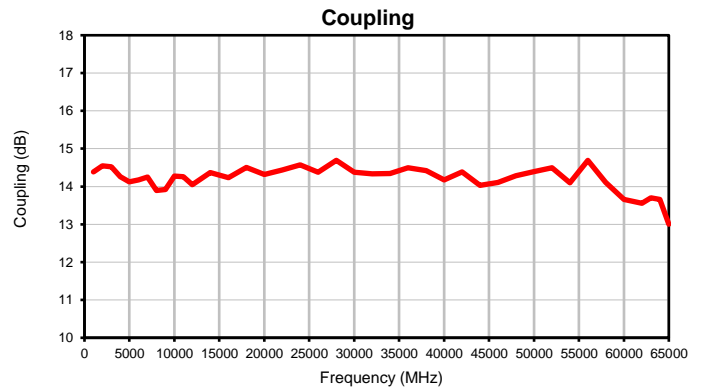

### Outline Dimensions

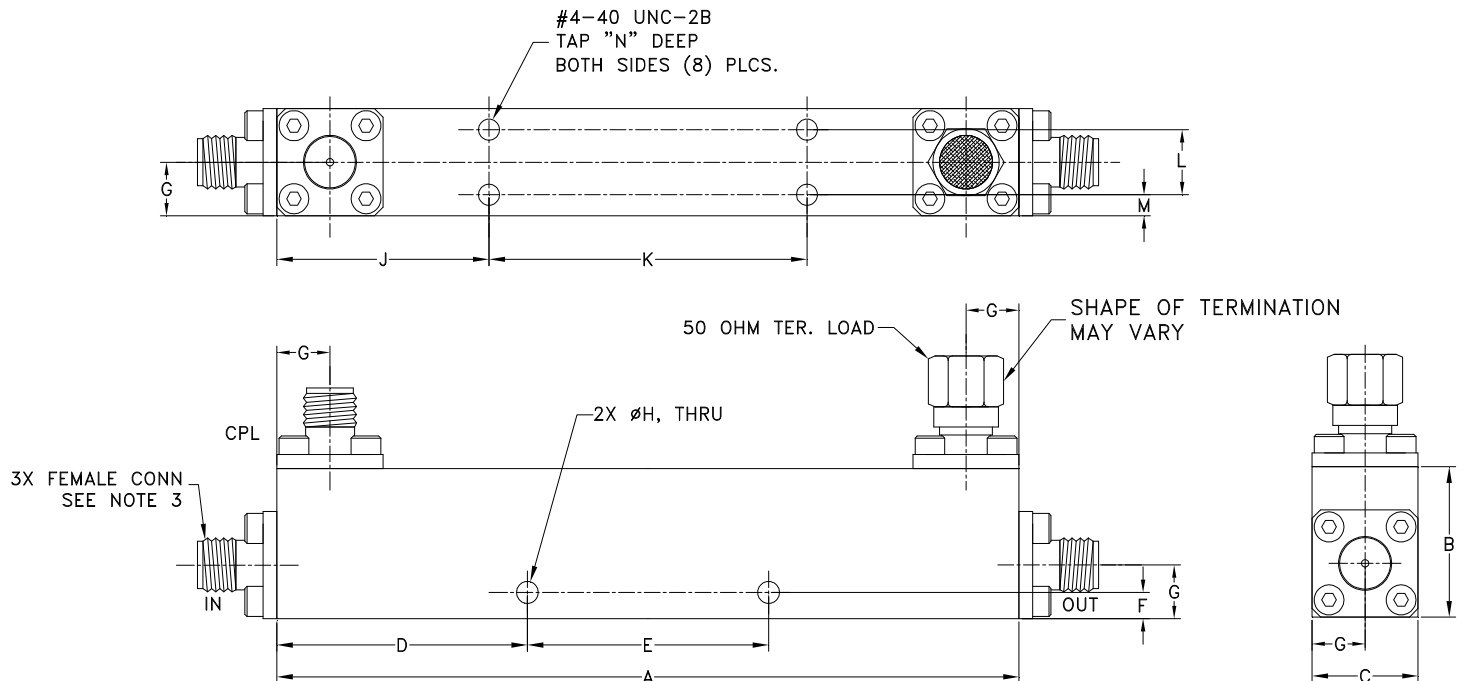

CASE #	A	B	C	D	E	F	G	H	J	K
HT2679	3.50 (88.90)	.70 (17.78)	.50 (12.70)	1.181 (30.00)	1.138 (28.90)	.122 (3.10)	.25 (6.35)	.102 (2.60)	1.000 (25.40)	1.500 (38.10)

CASE #	L	M	N	WT. GRAM
HT2679	.0303 (7.70)	0.098 (2.50)	0.20 (5.08)	80

Dimensions are in inches (mm). Tolerances: 2Pl.  $\pm .03$ ; 3Pl.  $\pm .015$

#### Notes:

1. Case material: Aluminum alloy.
2. Case finish: Painting. Color: Blue.
3. Refer to the individual model data sheet for the type of connectors available.

**Mini-Circuits**  
ISO 9001 ISO 14001 CERTIFIED

ALL NEW  
minicircuits.com

P.O. Box 350166, Brooklyn, New York 11235-0003 (718) 934-4500 Fax (718) 332-4661 For detailed performance specs & shopping online see Mini-Circuits web site



The Design Engineers Search Engine Provides ACTUAL Data Instantly From MINI-CIRCUITS At: [www.minicircuits.com](http://www.minicircuits.com)

RF/IF MICROWAVE COMPONENTS



All Mini-Circuits products are manufactured under exacting quality assurance and control standards, and are capable of meeting published specifications after being subjected to any or all of the following physical and environmental test.

<b>Specification</b>	<b>Test/Inspection Condition</b>	<b>Reference/Spec</b>
Operating Temperature	-55° to 100°C Ambient Environment	Individual Model Data Sheet
Storage Temperature	-55° to 100° C Ambient Environment	Individual Model Data Sheet
Barometric Pressure	100,000 Feet	MIL-STD-202, Method 105, Condition D
Humidity	90% RH, 65°C Units may require bake-out after humidity to restore full performance.	MIL-STD-202, Method 103
Thermal Shock	-65° to 125°C, 5 cycles	MIL-STD-202, Method 107, Condition B
Vibration (High Frequency)	20g peak, 10-2000 Hz, 12 times in each of three perpendicular directions (total 36)	MIL-STD-202, Method 204, Condition D
Mechanical Shock	100g, 6ms sawtooth, 3 shocks each direction 3 axes (total 18)	MIL-STD-202, Method 213, Condition I