

Coaxial Bandpass Filter

ZABP-650-S+

50Ω 560 to 780 MHz



Generic photo used for illustration purposes only
CASE STYLE: UU1842

The Big Deal

- High rejection
- Good VSWR
- Connectorized package

Product Overview

ZABP-650-S+ is a 50Ω bandpass filter with a rugged connectorized package covering the passband of 560 to 780 MHz. The bandpass filter offers good matching within the passband and provides high rejection. This filter has miniature high Q capacitors and wire welded inductors for high reliability. It has repeatable performance across lots and consistent performance across temperature.

Key Features

Feature	Advantages
High rejection	ZABP-650-S+ has sharper transition and rejects spurious signals in the stopband.
Good VSWR	This filter maintains typical VSWR over passband frequency range making this filter easier to integrate into receiver and transmitter RF chains with less concerns for in band frequency ripple.
Connectorized package	Connectorized package is easy to interface with other devices and well suited for test setups.

Notes

- A. Performance and quality attributes and conditions not expressly stated in this specification document are intended to be excluded and do not form a part of this specification document.
B. Electrical specifications and performance data contained in this specification document are based on Mini-Circuit's applicable established test performance criteria and measurement instructions.
C. The parts covered by this specification document are subject to Mini-Circuits standard limited warranty and terms and conditions (collectively, "Standard Terms"); Purchasers of this part are entitled to the rights and benefits contained therein. For a full statement of the Standard Terms and the exclusive rights and remedies thereunder, please visit Mini-Circuits' website at www.minicircuits.com/MCLStore/terms.jsp



Bandpass Filter

ZABP-650-S+

50Ω 560 to 780 MHz



Generic photo used for illustration purposes only

CASE STYLE: UU1842
Connectors Model
SMA-MF ZABP-650-S+

Features

- High rejection
- Good VSWR, 1.4:1 typical@ passband
- Connectorized package

Applications

- Receivers / transmitters
- Wireless communication systems
- Test equipment

Electrical Specifications at 25°C

Parameter		F#	Frequency (MHz)	Min.	Typ.	Max.	Unit
Pass Band	Center Frequency	-	-	-	650	-	MHz
	Insertion Loss	F1-F2	560 - 780	-	1.5	2.5	dB
	VSWR	F1-F2	560 - 780	-	1.4	1.8	:1
Stop Band, Lower	Insertion Loss	DC-F3	DC - 185	40	48	-	dB
		F3-F4	185 - 280	20	30	-	dB
	VSWR	DC-F4	DC - 280	-	20	-	:1
Stop Band, Upper	Insertion Loss	F5-F6	890 - 920	-	30	-	dB
		F6-F7	920 - 1600	40	51	-	dB
	VSWR	F7-F8	1600 - 3500	-	30	-	dB
		F5-F8	890 - 3500	-	20	-	:1

Maximum Ratings

Operating Temperature	-40°C to 85°C
Storage Temperature	-55°C to 100°C
RF Power Input	0.5 W max.

Permanent damage may occur if any of these limits are exceeded.

Functional Schematic

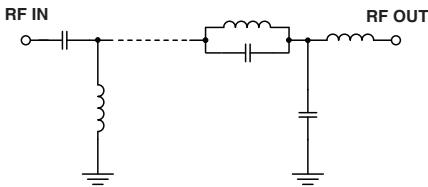

Typical Frequency Response

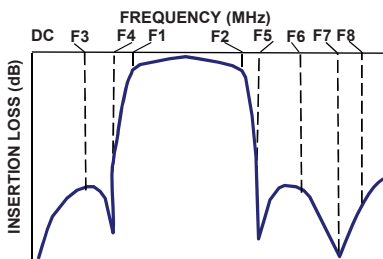

Typical Performance Data at 25°C

Frequency (MHz)	Insertion Loss (dB)	VSWR (:1)	Frequency (MHz)	Group Delay (ns)
1	99.51	7853.07	560	3.66
2	88.76	12412.85	565	3.62
185	49.02	359.33	570	3.58
260	33.91	142.78	580	3.52
280	30.32	112.86	590	3.47
335	20.82	60.53	600	3.44
475	3.24	4.00	610	3.43
490	2.41	3.02	615	3.44
500	1.96	2.52	620	3.45
560	0.84	1.22	645	3.56
650	0.83	1.19	650	3.58
780	1.47	1.08	655	3.62
795	2.29	1.57	660	3.66
800	3.01	2.03	675	3.78
845	21.19	15.15	700	4.04
865	30.39	20.17	715	4.26
890	42.19	24.69	725	4.45
920	58.02	28.39	750	5.16
1600	51.34	33.11	770	6.25
3500	42.52	16.89	780	7.21

+RoHS Compliant

The +Suffix identifies RoHS Compliance. See our web site for RoHS Compliance methodologies and qualifications

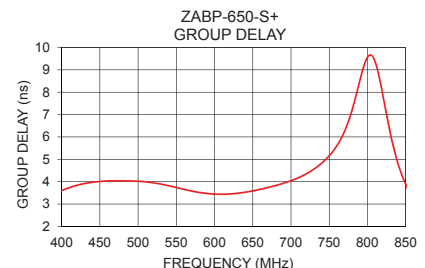
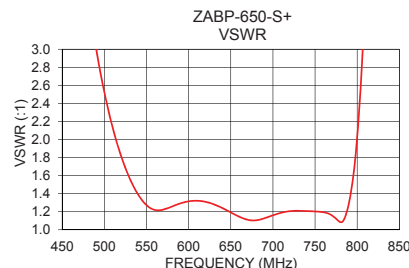
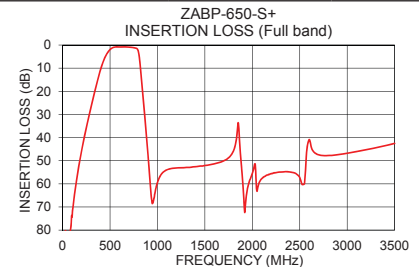
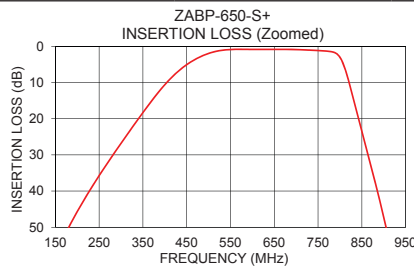

Notes

- Performance and quality attributes and conditions not expressly stated in this specification document are intended to be excluded and do not form a part of this specification document.
- Electrical specifications and performance data contained in this specification document are based on Mini-Circuit's applicable established test performance criteria and measurement instructions.
- The parts covered by this specification document are subject to Mini-Circuit's standard limited warranty and terms and conditions (collectively, "Standard Terms"); Purchasers of this part are entitled to the rights and benefits contained therein. For a full statement of the Standard Terms and the exclusive rights and remedies thereunder, please visit Mini-Circuit's website at www.minicircuits.com/MCLStore/terms.jsp



Coaxial Connections

PORT - 1	SMA-MALE
PORT - 2	SMA-FEMALE

Outline Drawing

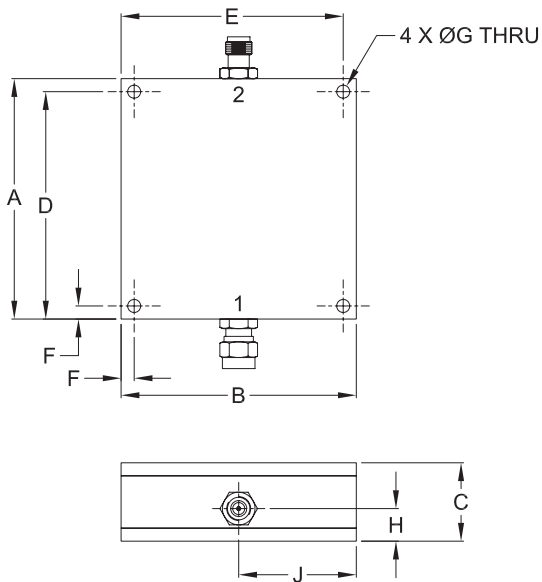

Outline Dimensions ($\frac{\text{inch}}{\text{mm}}$)

A	B	C	D	E
2.300	2.250	.750	2.175	2.125
58.42	57.15	19.05	55.25	53.98
F	G	H	J	wt.
.125	.125	.312	1.125	grams
3.18	3.18	7.93	28.58	124

Note: Please refer to case style drawing for details

Notes

- A. Performance and quality attributes and conditions not expressly stated in this specification document are intended to be excluded and do not form a part of this specification document.
- B. Electrical specifications and performance data contained in this specification document are based on Mini-Circuit's applicable established test performance criteria and measurement instructions.
- C. The parts covered by this specification document are subject to Mini-Circuits standard limited warranty and terms and conditions (collectively, "Standard Terms"); Purchasers of this part are entitled to the rights and benefits contained therein. For a full statement of the Standard Terms and the exclusive rights and remedies thereunder, please visit Mini-Circuits' website at www.minicircuits.com/MCLStore/terms.jsp

Typical Performance Data

FREQ. (MHz)	INSERTION LOSS			INPUT RETURN LOSS			OUTPUT RETURN LOSS		
	(dB)			(dB)			(dB)		
	@-40°C	@+25°C	@+85°C	@-40°C	@+25°C	@+85°C	@-40°C	@+25°C	@+85°C
1.0	95.46	101.94	92.07	0.00	0.00	0.00	0.00	0.00	0.00
2.0	98.49	104.88	102.45	0.00	0.00	0.00	0.00	0.00	0.00
10.0	102.97	96.66	107.01	0.00	0.00	0.00	0.01	0.01	0.01
50.0	99.02	94.72	94.83	0.00	0.00	0.01	0.03	0.04	0.04
100.0	73.71	73.17	73.63	0.01	0.01	0.02	0.08	0.11	0.12
150.0	57.41	57.44	57.35	0.02	0.04	0.04	0.18	0.21	0.22
185.0	48.74	48.78	48.80	0.04	0.06	0.07	0.24	0.27	0.29
200.0	45.45	45.48	45.49	0.05	0.08	0.08	0.26	0.29	0.31
250.0	35.59	35.56	35.51	0.10	0.12	0.14	0.29	0.33	0.36
260.0	33.76	33.72	33.66	0.11	0.14	0.15	0.29	0.34	0.37
280.0	30.18	30.13	30.04	0.14	0.17	0.18	0.30	0.36	0.40
330.0	21.50	21.49	21.40	0.25	0.29	0.31	0.39	0.47	0.53
335.0	20.65	20.64	20.56	0.26	0.30	0.33	0.41	0.50	0.56
350.0	18.14	18.15	18.09	0.33	0.37	0.40	0.50	0.60	0.66
400.0	10.47	10.47	10.50	0.85	0.93	0.97	1.21	1.36	1.44
470.0	3.46	3.48	3.47	3.87	4.10	4.29	4.32	4.63	4.90
475.0	3.14	3.18	3.16	4.28	4.51	4.73	4.72	5.04	5.34
490.0	2.32	2.38	2.38	5.74	6.01	6.31	6.13	6.50	6.91
500.0	1.88	1.96	1.96	6.94	7.23	7.59	7.32	7.72	8.21
550.0	0.80	0.93	1.00	15.88	16.06	16.20	17.43	18.10	18.58
560.0	0.74	0.88	0.96	17.44	17.43	17.39	19.68	20.16	20.28
600.0	0.71	0.85	0.92	17.79	17.75	18.12	18.37	18.32	18.69
650.0	0.68	0.82	0.90	23.36	24.36	26.34	21.75	22.33	23.65
680.0	0.69	0.84	0.94	31.27	29.97	27.95	30.07	28.92	27.60
700.0	0.75	0.91	1.02	22.88	22.47	22.08	22.82	22.25	21.82
740.0	0.93	1.11	1.23	19.12	19.62	20.39	17.62	17.74	18.08
780.0	1.21	1.47	1.68	35.01	40.99	38.37	30.38	28.63	25.48
795.0	1.91	2.36	2.75	13.58	12.61	11.84	12.50	11.37	10.38
800.0	2.54	3.11	3.61	9.73	9.12	8.58	8.84	8.08	7.40
845.0	20.03	20.93	21.73	1.03	1.19	1.27	0.70	0.79	0.84
865.0	29.18	30.03	30.78	0.75	0.89	0.97	0.48	0.56	0.62
870.0	31.48	32.33	33.08	0.72	0.85	0.93	0.45	0.53	0.58
890.0	41.06	41.91	42.63	0.61	0.73	0.79	0.36	0.44	0.49
900.0	46.29	47.16	47.89	0.57	0.68	0.75	0.33	0.41	0.46
920.0	58.84	60.04	60.52	0.53	0.63	0.69	0.29	0.36	0.41
1000.0	65.92	65.99	64.40	0.45	0.54	0.59	0.19	0.27	0.31
1050.0	59.07	59.11	58.34	0.43	0.52	0.57	0.17	0.24	0.28
1100.0	56.92	57.13	56.33	0.42	0.51	0.57	0.17	0.24	0.27
1250.0	55.65	55.68	55.11	0.37	0.48	0.57	0.18	0.25	0.29
1400.0	54.72	54.88	54.41	0.34	0.48	0.57	0.22	0.28	0.32
1500.0	53.82	53.96	53.71	0.34	0.49	0.59	0.24	0.31	0.34
1550.0	53.23	53.41	53.13	0.35	0.50	0.60	0.24	0.32	0.35
1600.0	52.63	52.78	52.50	0.35	0.51	0.61	0.26	0.33	0.36
1650.0	51.80	51.91	51.70	0.36	0.52	0.63	0.27	0.34	0.37
1750.0	48.85	48.91	48.76	0.39	0.55	0.67	0.28	0.36	0.39
2000.0	59.43	59.61	59.90	0.44	0.64	0.78	0.29	0.37	0.42
2100.0	57.63	57.98	58.28	0.46	0.67	0.81	0.29	0.37	0.41
2150.0	56.54	56.78	57.20	0.47	0.68	0.83	0.29	0.37	0.41
2250.0	55.21	55.56	56.11	0.49	0.71	0.87	0.28	0.37	0.41
2300.0	54.95	55.44	56.02	0.50	0.72	0.88	0.28	0.37	0.42
2450.0	55.57	55.98	57.14	0.53	0.77	0.93	0.27	0.36	0.42
2500.0	57.95	58.77	60.51	0.54	0.78	0.96	0.27	0.36	0.42
2600.0	39.31	40.75	42.35	0.60	0.84	1.02	0.31	0.39	0.44
2750.0	46.79	46.93	48.11	0.60	0.87	1.08	0.25	0.35	0.42
2800.0	46.74	46.83	48.13	0.61	0.89	1.10	0.25	0.36	0.42
2900.0	46.28	46.28	47.75	0.62	0.93	1.15	0.24	0.36	0.42
3000.0	45.53	45.46	47.17	0.65	0.96	1.21	0.26	0.38	0.44
3250.0	43.22	42.96	45.40	0.70	1.04	1.28	0.31	0.43	0.50
3400.0	41.56	41.06	44.12	0.73	1.05	1.27	0.34	0.47	0.54
3500.0	38.77	38.99	42.16	0.74	1.05	1.25	0.43	0.59	0.61

Typical Performance Data

FREQ. (MHz)	GROUP DELAY		
	(ns)		
	@-40°C	@+25°C	@+85°C
560.0	3.64	3.63	3.61
565.0	3.60	3.59	3.58
570.0	3.57	3.56	3.55
575.0	3.54	3.53	3.52
580.0	3.52	3.51	3.50
585.0	3.49	3.48	3.48
590.0	3.47	3.47	3.46
595.0	3.46	3.45	3.45
600.0	3.45	3.45	3.45
602.5	3.44	3.44	3.44
605.0	3.44	3.44	3.44
607.5	3.44	3.44	3.44
610.0	3.44	3.44	3.45
615.0	3.44	3.45	3.45
620.0	3.45	3.46	3.46
622.5	3.46	3.46	3.47
625.0	3.47	3.47	3.48
630.0	3.48	3.49	3.50
632.5	3.49	3.50	3.51
635.0	3.50	3.51	3.52
640.0	3.52	3.54	3.54
645.0	3.55	3.56	3.57
650.0	3.58	3.59	3.60
652.5	3.60	3.61	3.62
655.0	3.61	3.63	3.63
657.5	3.64	3.64	3.65
660.0	3.65	3.66	3.67
662.5	3.67	3.68	3.69
665.0	3.69	3.70	3.71
670.0	3.73	3.74	3.75
672.5	3.75	3.76	3.77
675.0	3.77	3.78	3.79
680.0	3.81	3.83	3.83
685.0	3.86	3.87	3.88
690.0	3.91	3.92	3.93
695.0	3.96	3.98	3.99
700.0	4.02	4.04	4.05
705.0	4.08	4.10	4.12
710.0	4.15	4.17	4.19
715.0	4.23	4.25	4.27
717.5	4.27	4.29	4.32
720.0	4.31	4.34	4.36
722.5	4.36	4.39	4.41
725.0	4.40	4.44	4.46
730.0	4.51	4.54	4.58
732.5	4.57	4.61	4.64
735.0	4.63	4.67	4.71
740.0	4.76	4.81	4.85
742.5	4.84	4.88	4.93
745.0	4.91	4.96	5.02
750.0	5.09	5.15	5.21
752.5	5.19	5.25	5.32
755.0	5.29	5.36	5.43
760.0	5.52	5.60	5.68
762.5	5.66	5.74	5.83
765.0	5.80	5.90	5.99
770.0	6.14	6.25	6.37
772.5	6.34	6.46	6.58
775.0	6.55	6.69	6.83
780.0	7.06	7.22	7.37

Typical Performance Curves

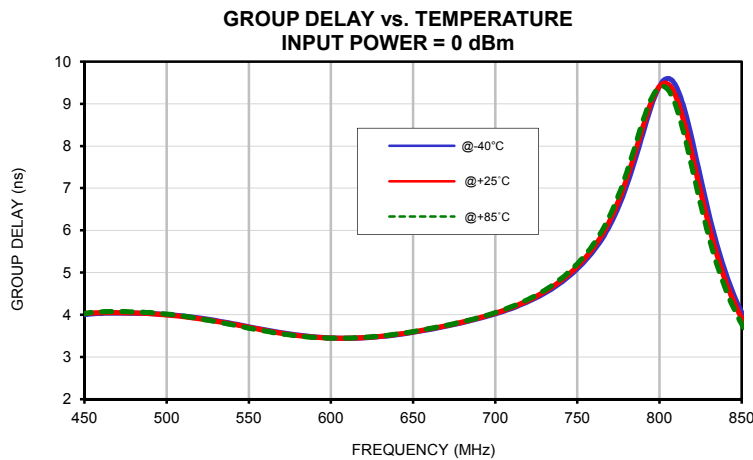
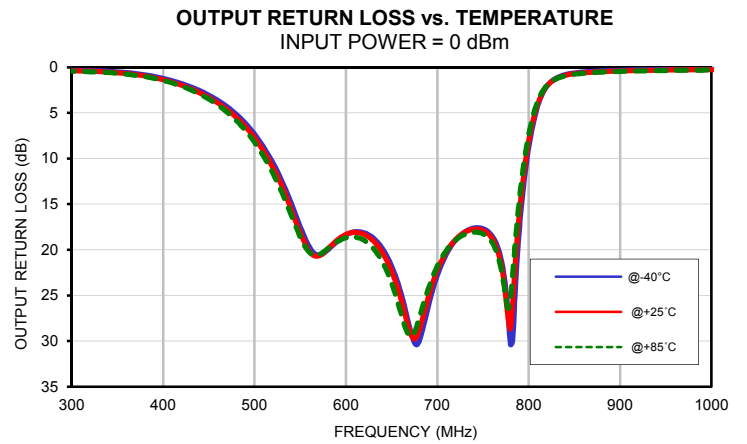
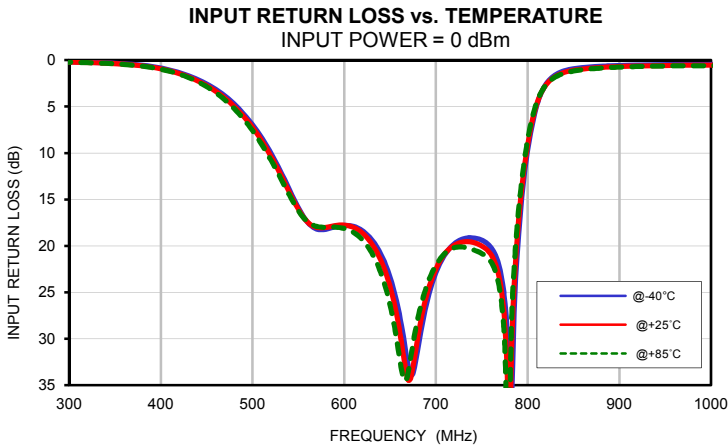
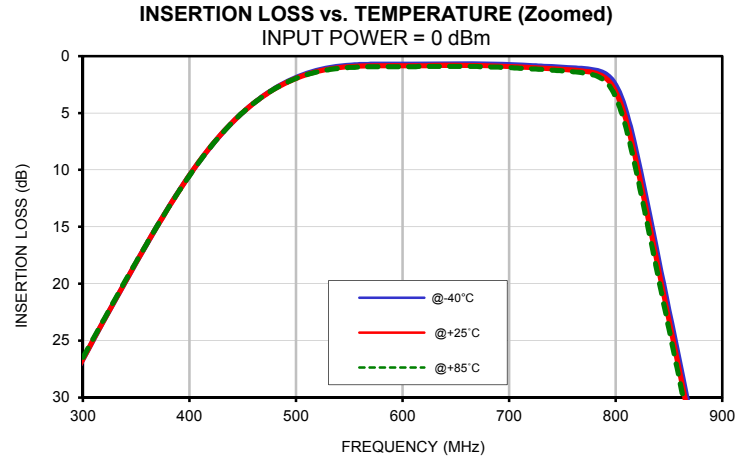
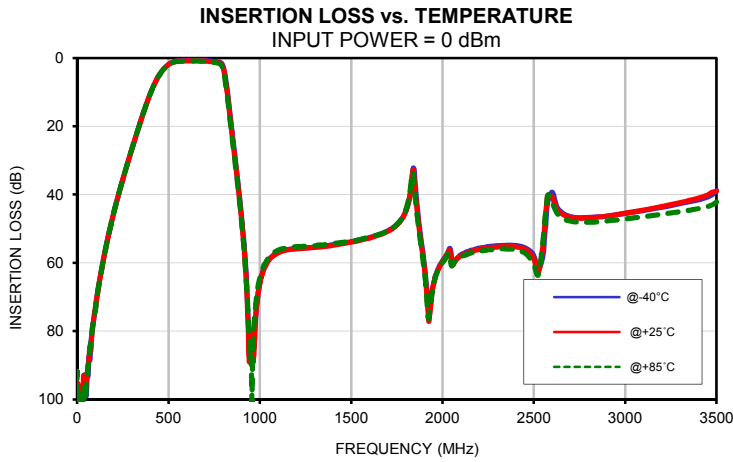

Outline Dimensions

UU1842

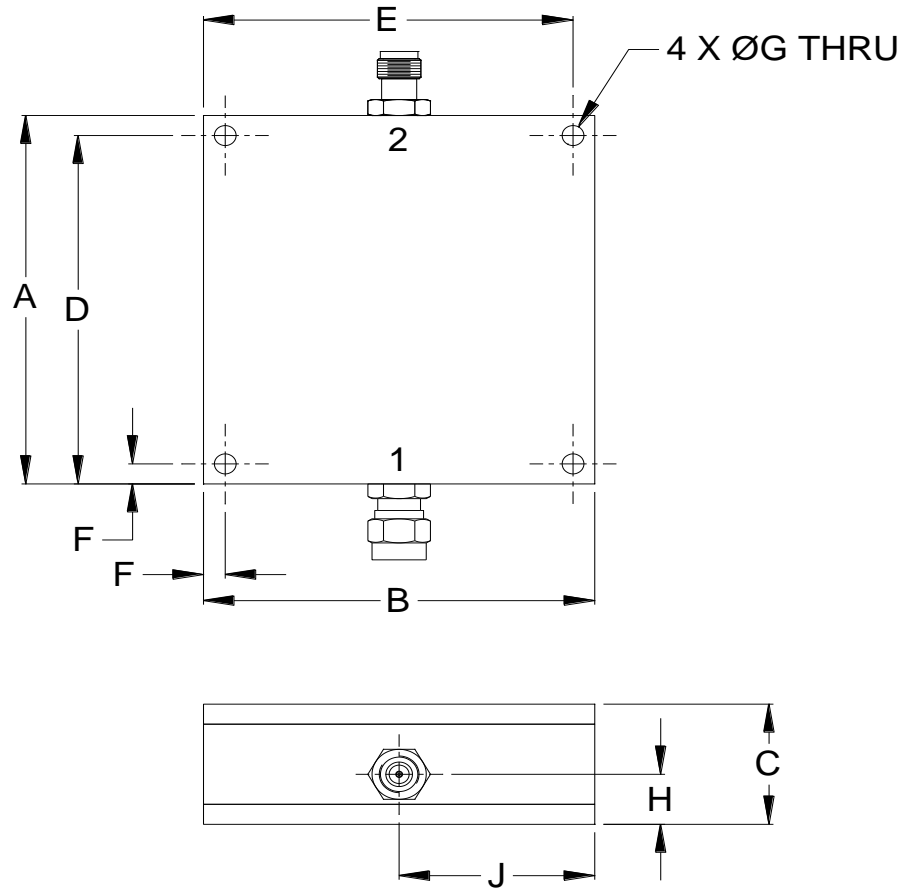

CASE#	A	B	C	D	E	F	G	H	J	WT.GRAMS
UU1842	2.300 (58.42)	2.250 (57.15)	0.750 (19.05)	2.175 (55.25)	2.125 (53.98)	0.125 (3.18)	0.125 (3.18)	0.312 (7.93)	1.125 (28.58)	124

Dimensions are in inches (mm). Tolerances: 2 Pl. $\pm .03$; 3 Pl. $\pm .015$

Notes:

- Case material: Aluminum alloy.
- Case finish:
For RoHS Case Styles: Clear chemical conversion coating, non-chrome or trivalent chrome based.



P.O. Box 350166, Brooklyn, New York 11235-0003 (718) 934-4500 Fax (718) 332-4661 For detailed performance specs & shopping online see Mini-Circuits web site



The Design Engineers Search Engine Provides ACTUAL Data Instantly From MINI-CIRCUITS At: www.minicircuits.com

RF/IF MICROWAVE COMPONENTS

All Mini-Circuits products are manufactured under exacting quality assurance and control standards, and are capable of meeting published specifications after being subjected to any or all of the following physical and environmental test.

Specification	Test/Inspection Condition	Reference/Spec
Operating Temperature	-55° to 100°C Ambient Environment	Individual Model Data Sheet
Storage Temperature	-55° to 100° C Ambient Environment	Individual Model Data Sheet
Humidity	90 to 95% RH, 40°C, 96 hours; Units may require bake-out after humidity to restore full performance.	MIL-STD-202, Method 103, Condition B
Thermal Shock	-55° to 100°C, 100 cycles	MIL-STD-202, Method 107, Condition A-3, except +100°C
Vibration (High Frequency)	20g peak, 10-2000 Hz, 12 times in each of three perpendicular directions (total 36)	MIL-STD-202, Method 204, Condition D
Mechanical Shock	50g, 11ms half-sine, 3 shocks each direction 3 axes (total 18)	MIL-STD-202, Method 213, Condition A